

# Vario/VarioPlus UFV10-0XX Series

Minimal Quantity Lubrication for Internal Lubrication

Assembly instructions acc. to EC Dir. 2006/42/EC  
for partly completed machinery, with associated operating instructions

EN



Version 04



## EC Declaration of Incorporation according to Machinery Directive 2006/42/EC, Annex II Part 1 B

The manufacturer SKF Lubrication Systems Germany GmbH , Werk Berlin Motzener Strasse 35/37, DE - 12277 Berlin hereby declares that the partly completed machinery:

Designation: **Vario/VarioPlus**  
Type: **UFV10-0XX**

Year of construction: See type identification plate

complies with the following basic requirements of the EC Machinery Directive 2006/42/EC at the time when first being launched in the market.

1.1.2 · 1.1.3 · 1.3.2 · 1.3.4 · 1.5.1 · 1.5.6 · 1.5.8 · 1.5.9 · 1.6.1 · 1.7.1 · 1.7.3 · 1.7.4

The special technical documents were prepared following annex II part B of this directive. Upon justifiable request, these special technical documents can be forwarded electronically to the respective national authorities. The person empowered to assemble the technical documentation on behalf of the manufacturer is the head of standardization; see manufacturer's address.

Furthermore, the following directives and harmonized standards were applied in the respective applicable areas:

**2011/65/EU** RoHS II  
**2014/30/EU** Electromagnetic compatibility | Industry

Standard	Edition	Standard	Edition
<b>DIN EN ISO 12100</b>	2011	<b>DIN EN 61000-6-3</b>	2011
Amendment	2013	Amendment	2012
<b>DIN EN 61000-6-2</b>	2006	<b>DIN EN 60947-1</b>	2011
Amendment	2011	<b>DIN EN 50581</b>	2013

The partly completed machinery must not be put into service until the final machinery into which it is to be incorporated has been declared in conformity with the provisions of the EC Machinery Directive 2006/42/EC and any other applicable directives.

Berlin 2016/01/29

Jürgen Kreuzkämper  
Manager R&D Germany  
SKF Lubrication Business Unit



Richard Lindemann  
Manager Sustain Engineering Berlin  
Lubrication Business Unit

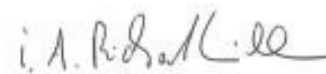

## Masthead

These assembly instructions pursuant to EC Machinery Directive 2006/42/EC are an integral part of the product described here and must be kept for future use.

### Warranty

The instructions do not contain any information on the warranty. This can be found in the General Terms and Conditions.

### Copyright / Integration of instructions

© SKF Lubrication Systems Germany GmbH.  
All rights reserved.

These instructions are protected by copyright.

The use of the contents for the purpose of integration into the documentation of the machine manufacturer in whose product it will be integrated is expressly allowed. This also includes the preparation of training documents for internal, non-commercial purposes. Any other usage of any kind without written permission of the rights holder is prohibited and constitutes a violation of copyright.

### Manufacturer and service address

If you have technical questions, please contact:

#### SKF Lubrication Systems Germany GmbH Berlin Plant

Motzener Strasse 35/37  
12277 Berlin  
Germany  
Tel. +49 (0)30 72002-0  
Fax +49 (0)30 72002-111  
[www.skf.com/lubrication](http://www.skf.com/lubrication)

#### Hockenheim Plant

2. Industriestrasse 4  
68766 Hockenheim  
Germany  
Tel. +49 (0)62 05 27-0  
Fax +49 (0)62 05 27-101  
[www.skf.com/lubrication](http://www.skf.com/lubrication)

## Table of contents





<b>Assembly instructions for partly completed machinery, with associated operating instructions</b>	<b>1</b>	<b>2. Lubricants</b>	<b>16</b>	4.6 Compressed air connection	33
Information concerning EC Declaration of Conformity and EC Declaration of Incorporation	2	2.1 General information	16	4.7 Electrical connections	34
Explanation of symbols and signs	6	2.2 Selection of lubricants	16	4.7.1 VarioPlus electrical connections	34
<b>1. Safety instructions</b>	<b>8</b>	2.3 Approved lubricants	17	4.7.2 Electrical fill level switches (XL2/XL3)	37
1.1 General safety instructions	8	2.3.1 Approved lubricants	18	4.8 Note on the rating plate	38
1.2 General behavior when handling the product	8	2.4 Lubricants and the environment	19	4.9 Notes on the CE marking	38
1.3 Authorized technical personnel	9	2.5 Lubricant hazards	19		
1.4 Electric shock hazard	10	<b>3. Overview</b>	<b>20</b>		
1.5 System pressure or hydraulic pressure hazard	10	<b>4. Assembly</b>	<b>22</b>		
1.6 Compressed air hazard	10	4.1 General information	22		
1.7 Operating minimal quantity lubrication (MQL) systems	11	4.2 Setup and attachment	23		
1.8 Assembly/maintenance/malfunction/decommissioning/disposal	12	4.2.1 Minimum mounting dimensions	24		
1.9 Intended use	12	4.3 Attaching Vario and VarioPlus MQL systems	24		
1.10 Foreseeable misuse	13	4.3.1 Vario port dimensions, assembly holes, and minimum mounting dimensions	25		
1.11 Disclaimer of liability	13	4.3.2 VarioPlus port dimensions, assembly holes, and minimum mounting dimensions	26		
1.12 Referenced documents	13	4.4 Connecting aerosol lines	27		
1.13 Warning labels on the product	14	4.5 Initial filling	30		
1.14 Residual risks	15	4.5.1 Depressurizing the aerosol generator	31		

<b>Operating instructions associated with assembly instructions</b>	<b>41</b>				
<b>1. Safety instructions</b>	<b>42</b>	6.2.1	Commissioning the Vario	54	<b>7. Operation/decommissioning and disposal</b> <b>75</b>
<b>2. Lubricants</b>	<b>42</b>	6.2.2	Commissioning the VarioPlus	56	7.1 Operation 75
		6.3	Electronic pressure switch	57	7.2 Temporary shutdown 75
		6.3.1	Digital display	58	7.3 Decommissioning and disposal 76
<b>3. Delivery, returns, and storage</b>	<b>43</b>	6.3.2	Output characteristics	58	
3.1 Checking the delivery	43	6.3.3	Setting for window function (WIN)	59	<b>8. Maintenance</b> <b>77</b>
3.2 Returns	43	6.3.4	Setting switching points and hystereses or switching points for the window function	60	8.1 General information 77
3.3 Storage	43	6.3.5	Setting the switching point in "diAG" and "2PS" modes	62	8.2 Filling the aerosol generator 78
3.3.1 Lubrication units	43	6.3.6	Setting the switching point in "Hys1" mode	63	8.2.1 Depressurizing the lubricant reservoir 78
3.3.2 Electronic and electrical devices	43	6.3.7	Setting ranges for switching outputs	64	8.2.2 Filling the aerosol generator 79
3.3.3 General notes	43	6.4	Basic settings of the electronic pressure switch	65	8.3 Draining lubricant from the aerosol reservoir 80
<b>4. Assembly</b>	<b>44</b>	6.4.1	Changing the basic setting	65	<b>9. Malfunctions, causes, and remedies</b> <b>82</b>
4.1 Information on assembly	44	6.4.2	Ending the basic setting	66	9.1 Commissioning, product, and system malfunctions 83
<b>5. Functional description</b>	<b>44</b>	6.4.3	Overview of basic settings	67	
5.1 Principle of minimal quantity lubrication (MQL)	44	6.4.4	Overview of setting options	70	<b>10. Technical data</b> <b>86</b>
5.2 The principle of aerosol action	44	6.5.1	Changing the operational programming releases	72	10.1 Vario 86
5.3 Design of the system	46	6.5	Programming releases	72	10.2 VarioPlus 87
5.3.1 Vario - Design and function	46	6.5.2	Changing the main programming releases	73	10.2.1 VarioPlus electronic pressure switch 88
5.3.2 VarioPlus - Design and function	49	6.6	Pin assignment	74	<b>11. Spare parts</b> <b>90</b>
<b>6. Commissioning</b>	<b>52</b>				<b>12. Accessories</b> <b>93</b>
6.1 General information	52				
6.2 Effects of primary pressure	52				

## Explanation of symbols and signs





You will find these symbols, which warn of specific dangers to persons, material as-sets, or the environment, next to all safety instructions in these assembly instructions/operating instructions.

Read the instructions completely and follow all operating instructions and the warning and safety instructions.

Warning level	Consequence	Probability
 <b>DANGER</b>	Death / serious injury	Immediate
 <b>WARNING</b>	Serious injury	Possible
 <b>CAUTION</b>	Minor injury	Possible
 <b>NOTE</b>	Property damage	Possible

Information symbols within the text	
Symbol	Meaning
●	Prompts an action
○	Used for itemizing
	Refers to other facts, causes, or consequences
→	Provides additional information within procedures

### Possible symbols

Symbol	Meaning
	Note
	Electrical component hazard, electric shock hazard
	Slipping hazard
	Hazard from hot components Hazard from hot surface
	Risk of being drawn into machinery
	Crushing hazard
	Danger from suspended load
	Pressure injection hazard
	Explosion-proof component
	Electrostatic sensitive components
	Wear personal safety equipment (goggles)
	Secure (lock) the closing device against accidental starting of the machine
	Environmentally sound disposal

Instructions placed on a unit, machine, or equipment, such as:

- o Rotation arrows
- o Fluid connection labels must be followed and kept in fully legible condition.
- o Warnings

Read the instructions thoroughly and follow them.

### Abbreviations and conversion factors

#### Abbreviations

re	regarding
approx.	approximately
°C	degrees Celsius
s	seconds
dB (A)	sound pressure level
i.e.	that is
etc.	et cetera
poss.	possibly
<	less than
±	plus or minus
>	greater than
e.g.	for example
if necessary	if necessary
etc.	et cetera
usually	usually
∅	diameter
incl.	including
K	Kelvin
kg	kilogram
rh	relative humidity
kW	kilowatt
l	liter
Min.	minute
max.	maximum
min.	minimum
mm	millimeter
ml	milliliter
N	Newton
Nm	Newton meter

oz.	ounce
psi	pounds per square inch
hp	horsepower
lb.	pound
sq.in.	square inch
kp	kilopond
cu.in.	cubic inch
mph	miles per hour
fpsec	feet per second
°F	degrees Fahrenheit
fl.oz.	fluid ounce
in.	inch
gal.	gallon

#### Conversion factors

Length	1 mm = 0.03937 in.
Area	1 cm <sup>2</sup> = 0.155 sq.in.
Volume	1 ml = 0.0352 fl.oz.
	1 l = 2.11416 pints (US)
Mass	1 kg = 2.205 lbs
	1 g = 0.03527 oz.
Density	1 kg/cm <sup>3</sup> = 8.3454 lb./gal. (US)
	1 kg/cm <sup>3</sup> = 0.03613 lb./cu.in.
Force	1 N = 0.10197 kp
Speed	1 m/s = 3.28084 fpsec
	1 m/s = 2.23694 mph
Acceleration	1 m/s <sup>2</sup> = 3.28084 ft./s <sup>2</sup>
Pressure	1 bar = 14.5 psi, = 0.1 MPa
Temperature	°C = (°F-32) x 5/9
Power	1 kW = 1.34109 hp

# 1. Safety instructions

## 1.1 General safety instructions

The operator must ensure that the assembly instructions/operating instructions are read and understood by all persons responsible for working on the product or who supervise or instruct such persons.

The assembly instructions/operating instructions must be kept readily available together with the product.

Note that the assembly instructions/operating instructions form part of the product and must accompany the product if sold to a new owner.

The product described here was manufactured according to the state of the art. Risks may, however, arise from its usage and may result in harm to persons or damage to other material assets.

Any malfunctions which may affect safety must be remedied immediately. In addition to the instructions, statutory regulations and general regulations for accident prevention and environmental protection must be observed.

## 1.2 General behavior when handling the product

- o The product may only be used in proper technical condition and according to the information in this manual.
- o Technical personnel must familiarize themselves with the functions and operation of the product. The specified assembly and operating steps and their sequences must be observed.
- o Any unclear points regarding proper condition or correct assembly/operation must be clarified. Operation is prohibited until issues have been clarified.
- o Unauthorized persons must be kept away from the product.
- o Responsibilities for different activities must be clearly defined and observed. Uncertainty seriously endangers safety.
- o Protective and safety mechanisms must not be removed, modified, or disabled during operation and must be checked for proper function and completeness at regular intervals.  
If protective and safety mechanisms must be removed, they must be reinstalled immediately following conclusion of work and then checked for proper function.
- o Any malfunctions that occur must be resolved according to responsibility. The operator of the system/machine must be notified in case of malfunctions outside the scope of responsibility.
- o Wear personal protective equipment.
- o Observe the relevant safety data sheets when handling lubricants.
- o Only rotary leadthroughs that are suitable for dry running may be used for internal lubrication.



- o Only lubricants that are approved for use in the MQL system may be delivered.

### 1.3 Authorized technical personnel

Only qualified technical personnel may install, operate, maintain, and repair the products described in the assembly instructions. Qualified technical personnel are persons who have been trained, assigned, and instructed by the operator of the final product into which the product described here is incorporated. Such persons are familiar with the relevant standards, rules, accident prevention regulations, and assembly conditions as a result of their training, experience, and instruction. They are qualified to carry out the required activities and in doing so recognize and avoid any potential hazards. The definition of qualified electricians and the prohibition against employing non-qualified personnel are laid down in DIN VDE 0105 and IEC 364.

Relevant country-specific qualifications for technical personnel apply for countries outside the scope of IEC 364.

The core principles of these country-specific qualification requirements for technical personnel cannot be below those of the two



standards mentioned above.

The operator of the final product is responsible for assigning tasks and areas of responsibility and for the responsibility and monitoring of the personnel. These areas must be precisely specified by the operator. The personnel must be trained and instructed if they do not possess the requisite knowledge.



Product training can also be performed by SKF in exchange for costs incurred.

The operator must ensure that its personnel have fully understood the content of the assembly instructions/operating instructions.



#### 1.4 Electric shock hazard

	 <b>WARNING</b>
	<p><b>Electric shock</b></p> <p>Performing work on products that have not been de-energized may result in serious injury or death. Assembly, maintenance, and repair work may only be performed on products that have been de-energized by qualified technical personnel. The supply voltage must be switched off before opening any of the product's components.</p>

#### 1.5 System pressure or hydraulic pressure hazard

	 <b>WARNING</b>
	<p><b>System pressure</b></p> <p>The product described here is pressurized during operation. Depressurize the product before starting any assembly, maintenance, or repair work.</p>

#### 1.6 Compressed air hazard

	 <b>WARNING</b>
	<p><b>Compressed air</b></p> <p>The product described here is pressurized during operation. Depressurize the product before starting any assembly, maintenance, or repair work.</p>

Depending on the design, the product may be able to be operated with compressed air. The compressed air must comply with at least quality class 5 as defined by ISO 8573-1:



- o Max. particle size/density  
40  $\mu\text{m}$  / 10  $\text{mg}/\text{m}^3$
- o Pressure dew point 7  $^{\circ}\text{C}$  (44,6  $^{\circ}\text{F}$ )
- o Water content max. 7,800  $\text{mg}/\text{m}^3$
- o Residual oil content max. 25  $\text{mg}/\text{m}^3$

## 1. Safety instructions

### 1.7 Operating minimal quantity lubrication (MQL) systems

The following must be observed during commissioning and operation.

- o All information within this manual and the information within the referenced documents
- o All laws/regulations that the operator must observe

	<b>WARNING</b>
	<p><b>Explosibility limit of aerosol</b> Open flames, sparks, and any lit or smoldering materials, etc. are prohibited. The permissible local aerosol concentration must not be exceeded. Do not spray aerosol on hot surfaces.</p>

The Vario and VarioPlus UF10-0XX minimal quantity lubrication systems may be used only in proper technical condition, in accordance with their intended use, and with due regard to safety and hazards, in compliance with the assembly and operating instructions and local safety regulations.

The area of the spray and rooms where the aerosol concentration exceeds the explosibility limit must be kept clear of any type of fire, e.g., in the form of open flames, sparks, lit cigarettes, etc. The aerosol must not be sprayed onto hot surfaces. Processing rooms into which the aerosol is fed must be equipped with an extraction system with filter technology appropriate to the lubricant employed.

To prevent a potential hazard from exceeding the permissible amount of aerosol in case of an error, the minimal quantity lubrication systems must be disconnected from the compressed air supply as quickly as possible. This can be done by actuating the

quick-release coupling on the compressed air connection port; see Chapter 4.5.1, "Depressurizing the lubricant reservoir."

### 1.8 Assembly/maintenance/malfunction/decommissioning/disposal

The following must be observed while working on the product.

- o All relevant persons (e.g., operating personnel, supervisors) must be informed of the activity prior to the start of work. Precautionary operational measures / work instructions must be observed.
- o Take appropriate measures to ensure that moving/detached parts are immobilized during the work and that no body parts can be pinched by unintended movements.
- o Assemble the product only outside the operating range of moving parts, at an adequate distance from sources of heat or cold.
- o Prior to performing work, the product and the machine/system in which the product is or will be integrated must be depressurized and secured against unauthorized activation.
- o All work on electrical components may be performed only with voltage-insulated tools.
- o Fuses must not be bridged. Always replace fuses with fuses of the same type.
- o Ensure proper grounding of the product.
- o Drill required holes only on non-critical, non-load-bearing parts.
- o Other units of the machine must not be damaged or their function impaired by the installation of the centralized lubrication system.
- o No parts of the centralized lubrication device may be subjected to torsion, shear, or bending.
- o Use suitable lifting gear when working with heavy parts
- o Avoid mixing up/incorrectly assembling disassembled parts. Label parts.

### 1.9 Intended use

The Vario and VarioPlus minimal quantity lubrication systems of UFV10-0XX series, also referred to in the following as MQL systems, were designed for internal lubrication and external lubrication of cutting tools for machining applications. Internal lubrication refers to the supply of aerosol by means of a tool spindle and tool directly to the friction point between the cutting edge and the cutting piece. External lubrication refers to the supply of aerosol via lubrication lines to a spray nozzle that sprays the aerosol onto the tool.

The lubricants required for the Vario/VarioPlus MQL system have special chemical and physical properties matched to the high requirements of the MQL technology employed in this system. For this reason, only the MQL lubricants approved by SKF and listed in Chapter 2, "Lubricants," in subchapter 2.3.1 may be used.

Any other usage is deemed non-compliant with the intended use.

### 1.10 Foreseeable misuse

- o Any usage of the product differing from the aforementioned conditions and stated purpose is strictly prohibited. Particularly prohibited are use:
- o In another, more critical explosion protection zone, if applied as ATEX
- o To feed / forward / store Group 1 dangerous fluids according to Directive 67/548/EEC
- o To feed / forward / store gases, liquefied gases, dissolved gases, vapors, or fluids whose vapor pressure exceeds normal atmospheric pressure (1013 mbar) by more than 0.5 bar at their maximum permissible operating temperature

### 1.11 Disclaimer of liability

- The manufacturer shall not be held liable for damage resulting from:
- o Failure to comply with these instructions
  - o The use of lubricants/media not approved for the unit type
  - o Contaminated or unsuitable lubricants
  - o Installation of non-original SKF components
  - o Inappropriate usage
  - o Improper assembly, configuration, or filling
  - o Improper response to malfunctions
  - o Non-observance of maintenance intervals
  - o Independent modification of system components

### 1.12 Referenced documents

In addition to this manual, the following documents must be observed by the respective target group:

- o Operational instructions and approval rules
- o Instructions from suppliers of purchased parts
- o Safety data sheet of the lubricant used
- o Project planning documents and other relevant documents, if provided

The operator must supplement these documents with applicable regulations for the country of use.

The documentation must be included if the product is transferred to a new operator.

### 1.13 Warning labels on the product

A warning label (item 1) is affixed to the product. Before commissioning, check that the label is present and intact. Immediately replace the label if it is damaged or missing. The product must not be operated until then.

See Figure 1 for the ordering number and item.

#### Warning label, item 1



#### ACHTUNG GEFAHR!

In Betrieb stehen der Behälter und Teile des Gerätes unter Druck. Der Behälter darf weder geöffnet, noch dürfen Geräteteile entfernt werden! Vor Inbetriebnahme alle Anschlüsse auf sicheren Sitz und Dichtheit prüfen. Vor Arbeiten am Gerät oder an den angeschlossenen Systemkomponenten muss das Gerät druckentlastet werden. Für Inbetriebnahme, Betrieb und Wartung sind die Hinweise der Bedienungsanleitung unbedingt zu beachten.



#### ATTENTION DANGER!

Reservoir and other parts of the unit are pressurized. Never open the reservoir or remove system components! Check connections for tightness and proofness before commissioning the system. Relief system pressure before maintenance work. Check operating manual for support while start up, operation and maintenance of the ur

Order No. 951-111-173

Positioning of warning labels, Fig. 1

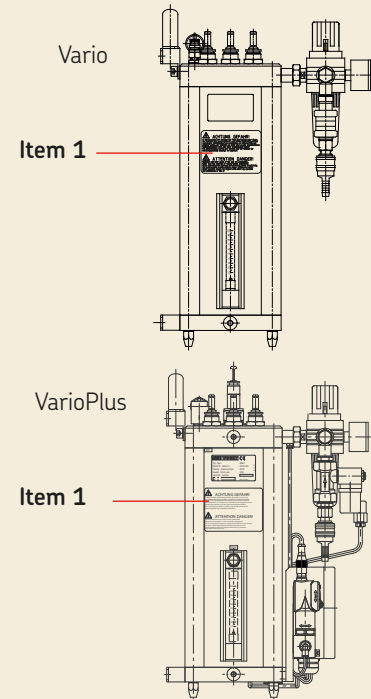

## 1.14 Residual risks

Assessment of residual risk, Table 1

Residual risk	Remedy
<b>Life cycle: Assembly</b>	
UFV10-OXX falling during the installation procedure	<ul style="list-style-type: none"> <li>• Install the MQL system using load lifters (e.g., a crane). Ensure adequate fastening/securing of the unit (loading capacity).</li> </ul>
<b>Life cycle: Commissioning / operation</b>	
People slipping due to floor contamination with spilled lubricant	<ul style="list-style-type: none"> <li>• Exercise caution when filling and when closing the filler socket cap.</li> <li>• Promptly apply suitable binding agents and remove the spilled lubricant.</li> <li>• Follow operational instructions for handling oils and contaminated parts.</li> </ul>
Tearing/damage to lines when installed on moving machine components	<ul style="list-style-type: none"> <li>• If possible, do not install on moving parts; if this cannot be avoided, use flexible hose lines.</li> </ul>
Lubricating oil spraying out due to faulty component fitting/line connection.	<ul style="list-style-type: none"> <li>• Tighten all components with the appropriate torques. Use hydraulic connections and lines suitable for the indicated pressures. These must be checked for proper connection and for damage prior to commissioning.</li> </ul>
<b>Life cycle: Malfunctions</b>	
Lubricant blockage on tool	<ul style="list-style-type: none"> <li>• Clean lubricant bores on the tool.</li> </ul>
<b>Life cycle: Maintenance</b>	
Overpressure at reservoir, filter, screw unions, and lines	<ul style="list-style-type: none"> <li>• The Vario/VarioPlus must be depressurized before maintenance work is performed.</li> </ul>
<b>Life cycle: Disposal</b>	
Environmental contamination by lubricants and wetted parts	<ul style="list-style-type: none"> <li>• Dispose of contaminated parts according to the applicable legal/company rules</li> </ul>

## 2. Lubricants

### 2.1 General information

#### NOTE

All products from SKF Lubrication Systems may be used only for their intended purpose and in accordance with the information in the product's assembly instructions.

Intended use is the use of the products for the purpose of providing minimal quantity lubrication within the physical usage limits which can be found in the documentation for the device, e.g. assembly instructions/operating instructions and the product descriptions, e.g. technical drawings and catalogs.

Particular attention is called to the fact that hazardous materials of any kind, especially those materials classified as hazardous by EC Directive 67/548/EEC, Article 2, Para. 2, may only be filled into minimal quantity lubrication systems and components and delivered and sprayed with such systems and components after consulting with and

obtaining written approval from SKF Lubrication Systems.

No products manufactured by SKF Lubrication Systems are approved for use in conjunction with gases, liquefied gases, pressurized gases in solution, vapors, or such fluids

whose vapor pressure exceeds normal atmospheric pressure (1013 mbar) by more than 0.5 bar at their maximum permissible temperature.

Other media which are classified as neither lubricant nor hazardous substance may only be fed after consulting with and obtaining written approval from SKF Lubrication Systems.

SKF Lubrication Systems considers lubricants to be an element of system design that must always be factored into the selection of components and the design of minimal quantity lubrication systems. The lubricating properties of the lubricants are critically important in making these selections.

### 2.2 Selection of lubricants

#### NOTE

Observe the instructions from the machine manufacturer regarding the lubricants that are to be used.

The amount of lubricant required at a lubrication point is specified by the machine manufacturer. It must be ensured that the required quantity of lubricant is provided to the lubrication point. The lubrication point may otherwise not receive adequate lubrication, which can lead to damage and failure of the tools.

When selecting a lubricant, the type of friction point, the expected loads during operation, and the anticipated ambient conditions must be taken into account. All economic and environmental aspects must also be considered.

Please contact SKF Lubrication Systems if you have further questions regarding lubricants.



### 2.3 Approved lubricants

#### NOTE

Only lubricants approved for the product may be used, see Chapter 2.3.1. Unsuitable lubricants can lead to failure of the product and to property damage.

#### NOTE

Different lubricants must not be mixed together. Doing so can cause damage and require extensive and complicated cleaning of the product/minimal quantity lubrication system. It is recommended that an indication of the lubricant in use be attached to the aerosol generator in order to prevent accidental mixing.

The product described here must be operated only using lubricants that meet the specifications in the technical data.

Note that in rare cases, there may be lubricants whose properties are within the permissible limits values but whose other characteristics render them unsuitable for use in minimal quantity lubrication systems. For example, the use of lubricants with anti-fogging additives in minimal quantity lubrication (MQL) systems for internal lubrication may not result in aerosol formation.

#### NOTE

Follow the safety instructions on the lubricant's safety data sheet.

## 2.3.1 Approved lubricants

Permissible lubricants approved by SKF, Table 2

Description	Composition	Features	Area of application	Drum size [liters]	Order number
LubriOil	Fatty acid ester with additives	Viscosity at 40°C (104 °F): 47 mm <sup>2</sup> /s  Density at 20°C (68 °F): 0.92 g/cm <sup>3</sup>	o Universal applications	1 2.5 5 10 200	OEL1-LUBRIOIL OEL2.5-LUBRIOIL OEL5-LUBRIOIL OEL10-LUBRIOIL OEL200-LUBRIOIL
LubriFluid F100	Synthetic polyesters based on natural fatty oil derivatives with oxidation inhibitors	Viscosity at 40°C (104 °F): 25 mm <sup>2</sup> /s  Density at 20°C (68 °F): 0.84 g/cm <sup>3</sup>	o Especially for small tools and difficult lubrication tasks on aluminum, steel, and non-ferrous metals	1 2.5 5 10 200	OEL1-LUBRI-F100 OEL2.5-LUBRI-F100 OEL5-LUBRI-F100 OEL10-LUBRI-F100 OEL200-LUBRI-F100

## 2.4 Lubricants and the environment



### NOTE

Lubricants can contaminate soil and waterways. Lubricants must be used and disposed of properly. Observe the local regulations and laws regarding the disposal of lubricants.



It is important to note that lubricants are environmentally hazardous, flammable substances which require special precautionary measures during transport, storage, and processing. Consult the safety data sheet from the lubricant manufacturer for information regarding transport, storage, processing, and environmental hazards of the lubricant that will be used.



The safety data sheet for a lubricant can be requested from the lubricant manufacturer.

## 2.5 Lubricant hazards

		<b>WARNING</b>
	<b>Lubricants</b>	Minimal quantity lubrication systems must always be free of leaks. Leaking lubricant is hazardous due to the risk of slipping and injury. Be mindful of any lubricant leaking out during assembly, operation, maintenance, and repair of minimal quantity lubrication systems. Leaks must be sealed off without delay.

Lubricant leaking from minimal quantity lubrication systems is a serious hazard. Leaking lubricant can create risks that may result in physical harm to persons or damage to other material assets.

		<b>WARNING</b>
	<b>Explosibility limit of aerosol</b>	Uncontrolled spraying of lubricants or lubricant-containing substances is prohibited because it may form lubricant/air mixtures with explosive concentrations.

		<b>WARNING</b>
	<b>Health hazard from aerosol</b>	Uncontrolled spraying of aerosol can be harmful to health. Do not spray people or animals with aerosol. The aerosol must not enter eyes and never be directly inhaled.

## 3. Overview

Overview of standard Vario version, Fig. 2

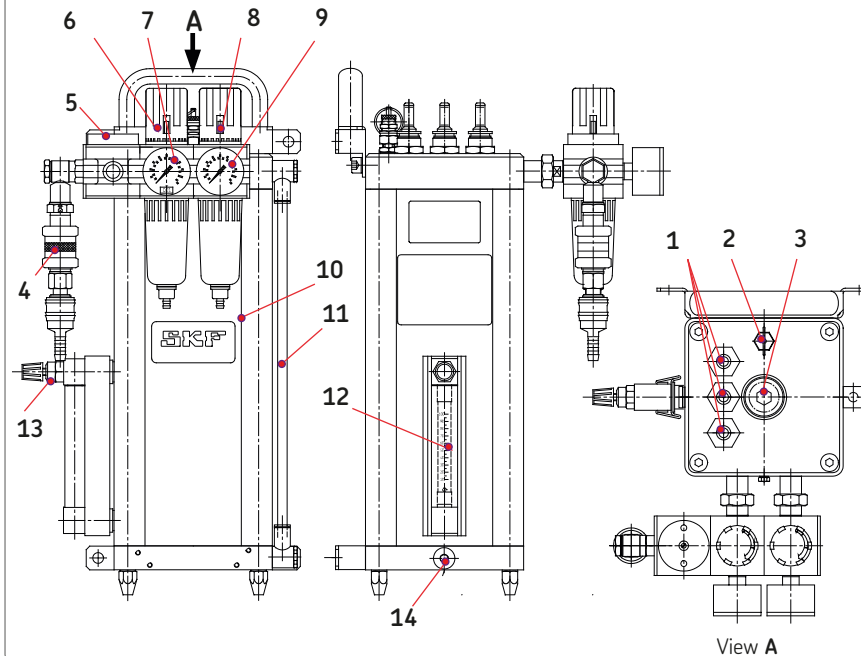

Item	Description
1	Aerosol outlets (3x)
2	Pressure relief valve
3	Screw plug for lubricant fillport, optionally with check valve
4	Main air valve with compressed air connection port (nom. size 7-8 mm)
5	Air supply unit
6	Rotary knob pressure control valve for auxiliary air
7	Pressure gauge for auxiliary air pressure
8	Rotary knob pressure control valve for primary pressure
9	Pressure gauge for primary air pressure
10	Aerosol generator
11	Lubricating oil fill level indicator
12	Variable rate flow meter
13	Oil valve setting screw
14	Oil drain plug

Overview of standard VarioPlus version, Fig. 3

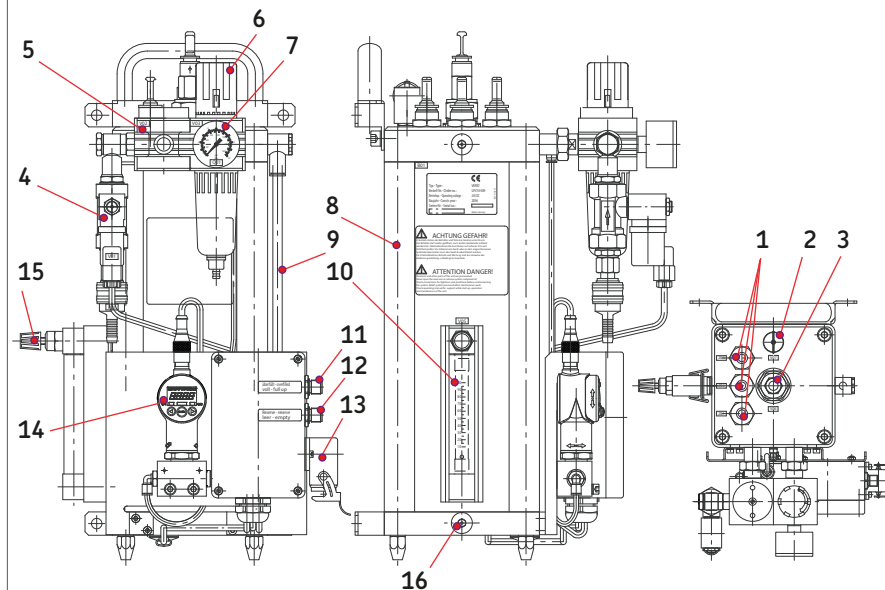

Item	Description
1	Aerosol outlets (3x)
2	Pressure relief valve (12 bar)
3	Screw plug for lubricant fillport, optionally with check valve
4	Main air valve, optionally with electric shut-off valve and/or compressed air connection port (nom. size 7-8 mm)
5	Air supply unit
6	Rotary knob pressure control valve for primary pressure
7	Pressure gauge for compressed air primary pressure
8	Aerosol generator
9	Lubricating oil fill level indicator
10	Variable rate flow meter
11	Connection for fill level monitoring, switch 1
12	Connection for fill level monitoring, switch 2
13	Connector socket for items 4 and 14
14	Electronic pressure switch
15	Oil valve setting screw
16	Oil drain plug

## 4. Assembly

### 4.1 General information



Only qualified technical personnel may install, operate, maintain, and repair the Vario and VarioPlus (UFV10-0XX) minimal quantity lubrication systems described in the assembly instructions.

Qualified technical personnel are persons who have been trained, assigned and instructed by the operator of the final product into which the described minimal quantity lubrication system is incorporated.

Such persons are familiar with the relevant standards, rules, accident prevention regulations, and operating conditions as a result of their training, experience, and instruction. They are qualified to carry out the required activities and in doing so recognize and avoid potential hazards.

The definition of qualified personnel and the prohibition against employing non-qualified personnel are laid down in DIN VDE 0105 and IEC 364.

Before assembling/setting up the product, the packaging material and any shipping braces (e.g., plugs) must be removed. The packaging material must be preserved until any discrepancies are resolved.

	 <b>CAUTION</b>
	<b>Tilting/dropping hazard / vertical installation</b> Do not tilt or drop the product. For proper functioning, the system must be installed vertically. The MQL system must not be installed upside down.

### NOTE

Observe the technical data (Chapter 10).

The MQL system should be assembled and commissioned according to the following sequence:

- o Set up and attach
- o Connect the aerosol and compressed air lines
- o Establish electrical connection and set software configuration in machine control unit.



## 4.2 Setup and attachment

The MQL system should be protected from humidity and vibration but should be mounted so that it is easily accessible, allowing all further installation work to be done without difficulty. All visual indicators must be clearly visible and all controls must be easily accessible.

The MQL system must not be subjected to rapid and severe temperature fluctuations. During assembly and especially when drilling, always pay attention to the following:

- o The fill level of the reservoir must be clearly visible.
- o The MQL system must be mounted in a vertical position.
- o Any assembly holes must be made according to the following drilling template (Fig. 6).
- o Design specifications and conditions of the manufacturer and the object must be observed when installing the MQL system.
- o Existing lines/units must not be damaged.

- o The product must be installed at an adequate distance from sources of heat or cold.

		<b>WARNING</b>
	<p><b>Personal injury/property damage</b>          Drill assembly holes in such a way that no lines, units, or moving parts are damaged or their function impaired.          Maintain safety clearances and comply with regulations for assembly and accident prevention.</p>	

		<b>WARNING</b>
	<p><b>Bodily injury</b>          Do not step below a raised or hanging MQL system.</p>	

The MQL system is installed on the machine using M8 screws (4x) with a minimum length of 20 mm.

Fastening material provided by customer.

Example:

- o Hexagon head screws acc. to ISO 4017- M8x20-8.8 (4x)
- o Washers (4x) acc. to ISO 7090-8-200HV

#### 4.2.1 Minimum mounting dimensions

To ensure enough space for maintenance work and possible disassembly of the product, ensure that the minimum mounting dimensions (Figs. 4 and 5) are maintained.

#### 4.3 Attaching Vario and VarioPlus MQL systems

☞ See Figures 4 and 5

- Drill assembly holes (M8) acc. to the relevant assembly drawing and the conditions on the surface.
- Clean surface to remove drilling chips.
- Lift the MQL system using a hoist and align it to the assembly holes.
- Pass hexagon head screws (4x) acc. to ISO 4017- M8x20-8.8 with associated washers (4x) acc. to ISO 7090-8-200HV through the fixing holes on the mounting plate and apply the screws to the M8 threads on the surface.
- Gently tighten hexagon head screws (4x).
- Align the MQL system horizontally and vertically, then tighten hexagon head screws with the following tightening torque

**Torque: 25 Nm**



## 4.3.1 Vario port dimensions, assembly holes, and minimum mounting dimensions

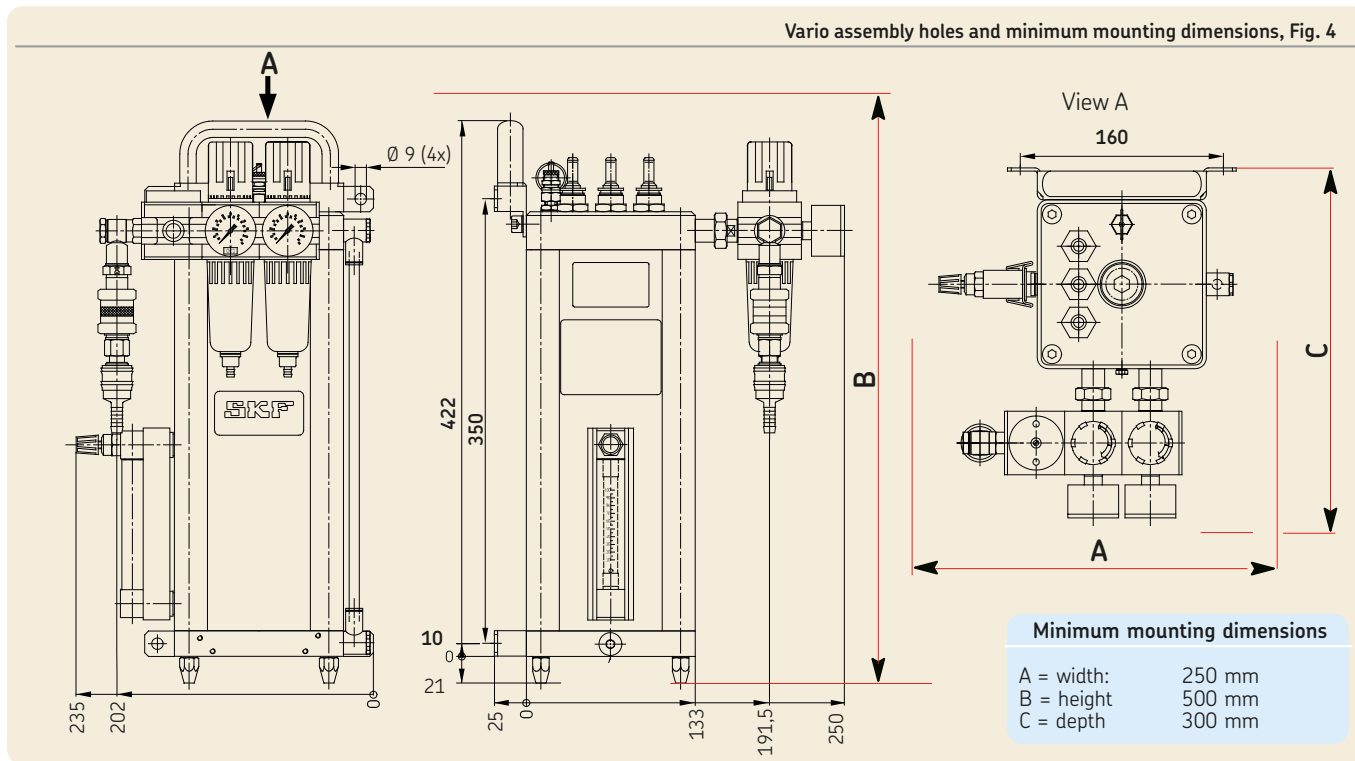

### 4.3.2 VarioPlus port dimensions, assembly holes, and minimum mounting dimensions

VarioPlus assembly holes and minimum mounting dimensions, Fig. 5

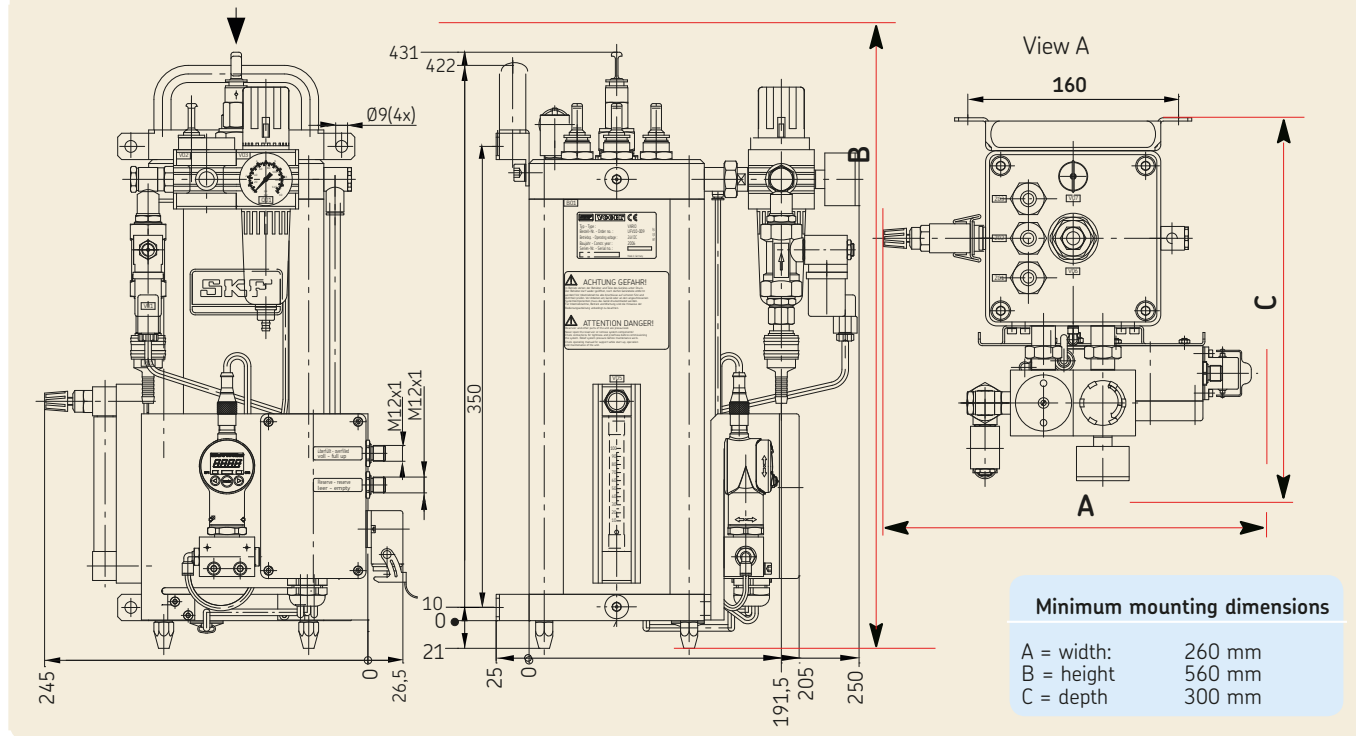

Mounting template, Fig. 6

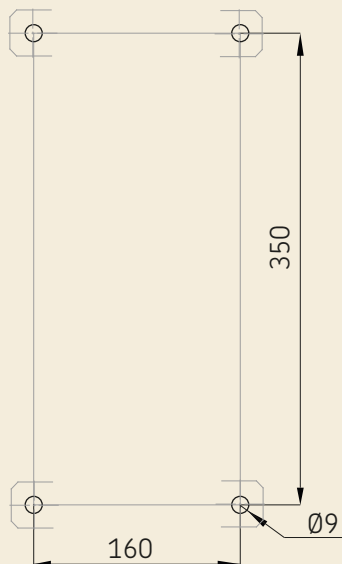

#### 4.4 Connecting aerosol lines

The Vario and VarioPlus MQL systems come with three aerosol outlets that are designed as plug-in connections for hoses with an outer diameter of 12 mm.

#### NOTE

Only pneumatic hoses that withstand operating pressures of at least 10 bar and are resistant to the lubricants may be used.



#### WARNING

##### System pressure

The product described here is pressurized during operation. Depressurize the product before starting assembly work.

By default, only one aerosol outlet is used. The two alternative outlets are closed with plugs.

Aerosol connections, Fig. 7

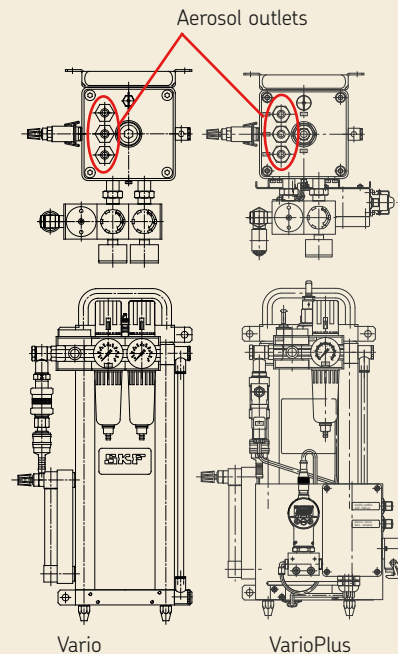

Several factors determine the quantity of lubricant that emerges as an aerosol at the tool. These include the cross-sections of lines and guideways in the aerosol transport route, from the MQL system to the outlet opening on the tool. The following rules must be followed to reduce loss of aerosol and pressure during transport:

- o Lubricant should not be fed through sharp changes in cross-sections, narrow passes, or abrupt bends because it may deposit at these locations and thus become unavailable for application.
- o The line cross-section must be large enough to transport an adequate quantity of lubricant. However, the duct diameter in the area of the tool should be < 8 mm because higher flow velocity is desired here.
- o The aerosol line should be kept as short as possible. Pressure and aerosol losses increase at longer aerosol line lengths.
- o The aerosol lines should be laid as straight as possible, and sharp bends should be avoided in particular. Otherwise, there is a risk that the lubricant will settle. If deflections cannot be avoided, they should have a radius of at least 200 mm.
- o The aerosol line should have as few changes in cross-section as possible. If cross-section changes are unavoidable, they should be as smooth as possible. A transition angle of <math><15^\circ</math> is ideal.
- o All joints should have a smooth surface and have no holes or projecting edges. This applies especially to the transition area between the tool and toolholder.
- o The aerosol lines should be laid in the lowest-vibration arrangement possible.
- o The aerosol line should rise continuously to the machine. Downward bends should be avoided where possible, since lubricant could accumulate in these areas, for example when the machine is at standstill.
- o If it is impossible to lay the aerosol lines without any downward bends, the accumulated lubricant must be blown out at regular intervals with the tool removed.
- o Aerosol feeding to spindles or rotating tools should be in the axial direction. Radial feeding, especially at high spindle speeds, can lead to “centrifuging” of the lubricant, i.e., the aerosol will decompose. This is particularly important for applications with small and fast-rotating tools.
- o The outlet of the cooling duct bore on the tool should not lie only on the tool’s cutting edge, as is usually the case with many tools for full spray lubrication. Optimal results are not attained when such tools are used, whereas minimal quantity lubrication systems can achieve much better results. Because of the considerably lower operating pressure of minimal quantity lubrication systems in comparison to full spray lubrication, the point between the tool and the workpiece is inadequately lubricated.

The following notes apply to the rotary leadthroughs and spindles of the machine tools:

**NOTE**

Only rotary leadthroughs that are suitable for dry running may be used. The small lubricant quantities that are used for minimal quantity lubrication are insufficient for lubricating the rotary leadthrough.

Disregarding this fact could lead to considerable damage to the machine tool. Please contact the machine manufacturer and ask whether the rotary leadthrough of the machine tool is suitable for dry running

**NOTE**

Rotary leadthroughs and spindles with integrated check valves must be modified.

Check valves are often built into rotary leadthroughs and spindles by the machine manufacturer. These check valves must be removed since it cannot be ensured that they would open completely because of the low operating pressure of the MQL system. Sufficient lubrication of the cutting process is therefore not ensured.

Please contact the machine manufacturer and ask how the check valves can be removed.

Please contact SKF Service if you have additional questions concerning installation of the MQL system; see the "Service" chapter, p. 3.

## 4.5 Initial filling

☞ See Figure 8



### NOTE

Only lubricants provided by SKF may be used (see Chapter 2.3.1). SKF will not accept claims for damages resulting from the use of lubricants other than those approved by SKF.

### NOTE

Only fill using clean lubricant and an appropriate device. SKF recommends the use of a filling funnel with integrated fine strainer insert.

The first time the MQL system is used, the reservoir is filled prior to connecting the system to the customer's compressed air supply.

		<b>WARNING</b>
	<p><b>System pressure</b> If the system is already connected to the compressed air supply, you must depressurize the reservoir before filling (see Chapter 4.5.1).</p>	

- If applicable, depressurize the aerosol generator **(1)** (see Chapter 4.5.1).
- Clean any contaminants from the outside of the Vario/VarioPlus.
- Remove the screw plug (hexagon socket, WAF 12) **(7)** (optionally with check valve WAF 27).
- Remove the screw plug **(7)** with the associated washer.

### NOTE

No aerosol can be generated if the reservoir is overfilled (fill level above the "Maximum" mark on the sight glass). Excess lubricant must therefore be drained in such cases. This is done by opening the oil drain plug (see Figure 2, item 14 for the Vario MQL system or Figure 3, item 16 for VarioPlus).

- Fill lubricant up to the "Maximum" sight glass mark using a funnel.
- Apply the screw plug **(7)** with washer to the aerosol generator **(1)**. Ensure that the washer is in the correct position beforehand.
- Fasten the screw plug **(7)** finger-tight.
- Clean any oil residues from the lubricant reservoir **(1)**.

### 4.5.1 Depressurizing the aerosol generator

☞ See Figure 8

	<b>NOTE</b>
	<b>Escaping aerosol</b> Aerosol may escape during subsequent actuation of the pressure relief valve (6).

To depressurize the MQL system, first disconnect it from the customer's compressed air supply. Then relieve the pressure in the MQL aerosol generator (1).

- Switch off the customer's compressed air supply.

☞ Once the compressed air supply is turned off, depressurize the aerosol generator (1).

Depending on the optional design of the MQL system, this is done as follows:

Disconnect the compressed air line from the system and push the coupling (2) downwards.

**or:**

- Move the slider (3) on the main compressed air valve downwards.

**or:**

- Close electric main valves (4) via the customer's machine control unit.

Then:

- Briefly actuate the pressure relief valve (6) using the key ring (5).
- Use a pressure gauge (8) to check whether the pressure has been completely released; if necessary, briefly actuate the pressure relief valve (6) again.

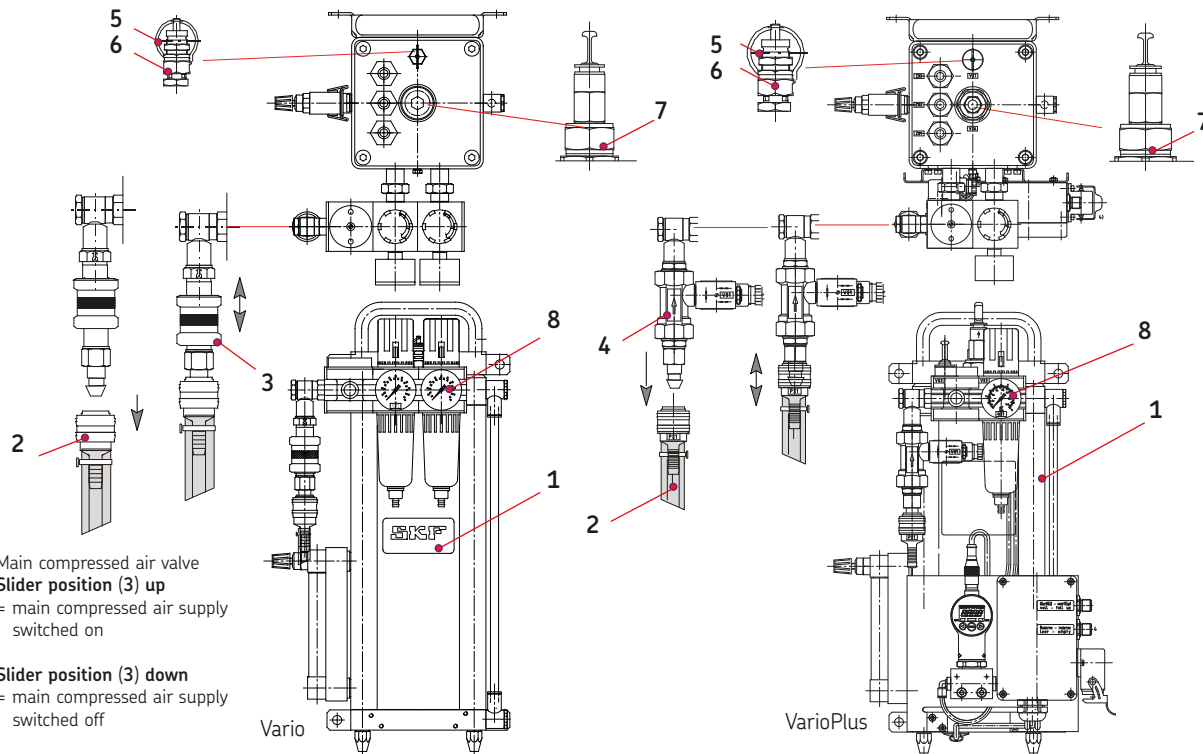

Depressurizing the aerosol generator, Fig. 8





## 4.6 Compressed air connection



☞ See Figure 9

	 <b>WARNING</b>
<b>System pressure</b>	
Depressurize the MQL system before connecting it to the compressed air supply.	

The MQL system has a coupling socket with nom. size 8 for hoses with an inside diameter of 7-8 mm for connection to the compressed air supply.

- See Table 3 for the requirements for the supplied compressed air.

The MQL system can operate with an inlet air pressure as low as 6 bar. However, the system reaches its peak performance only with an inlet air pressure from  $\geq 8$  bar to max. 10 bar.

	 <b>WARNING</b>
<b>System pressure</b>	
Observe the maximum inlet air pressure of max. 10 bar.	

### Compressed air requirements, Table 3

Requirements	Values
Maximum inlet air pressure	10 bar
Minimum inlet air pressure <sup>1)</sup>	6 bar
Supply pressure when discharging 300 standard liters/min	max. 6 bar Overpressure
Compressed air quality class acc. to ISO 8573-1	5
Maximum particle size	40 $\mu\text{m}$
Maximum particle density	0.1 $\text{mg}/\text{m}^3$
Maximum pressure dew point	+7°C (44,6 °F)
Maximum concentration of third-party lubricant	25 $\text{mg}/\text{m}^3$

<sup>1)</sup> Depends on the diameter of the tool's cooling duct (back pressure)

- Connect the compressed air supply via the coupling socket (1).

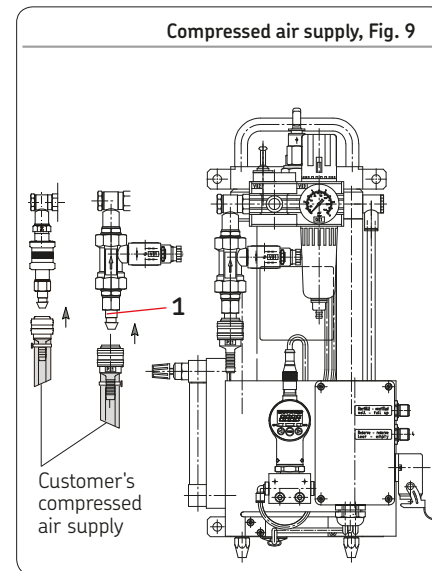

## 4.7 Electrical connections

### 4.7.1 VarioPlus electrical connections

See Figures 10 to 13

#### NOTE

The electrical connection of the MQL system may only be established by qualified and trained technical personnel. The instructions in this manual must be observed.

#### NOTE

On the MQL system's electrical connections, ensure that appropriate measures prevent interference between signals due to inductive, capacitive, or electro-magnetic couplings. Shielded cables must be used in places where electrical interference fields can distort signal transmissions despite separate laying of cables. The rules and empirical values for "EMC-compliant" cabling must be taken into consideration.

Assignment of Harting connector, VarioPlus,

Fig. 10

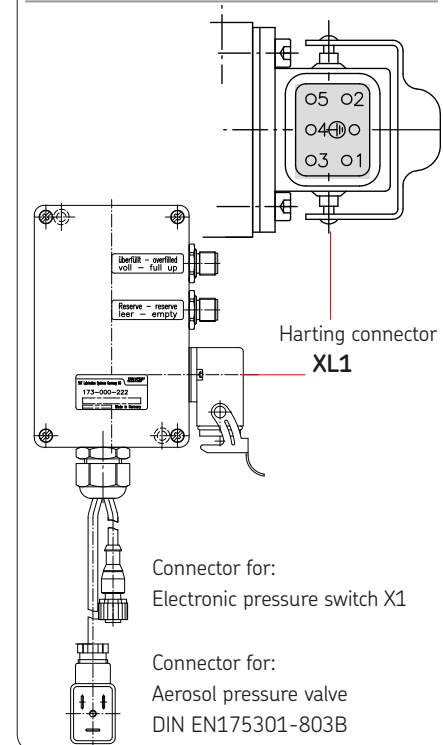

Assignment of Harting connector, VarioPlus, Fig. 11

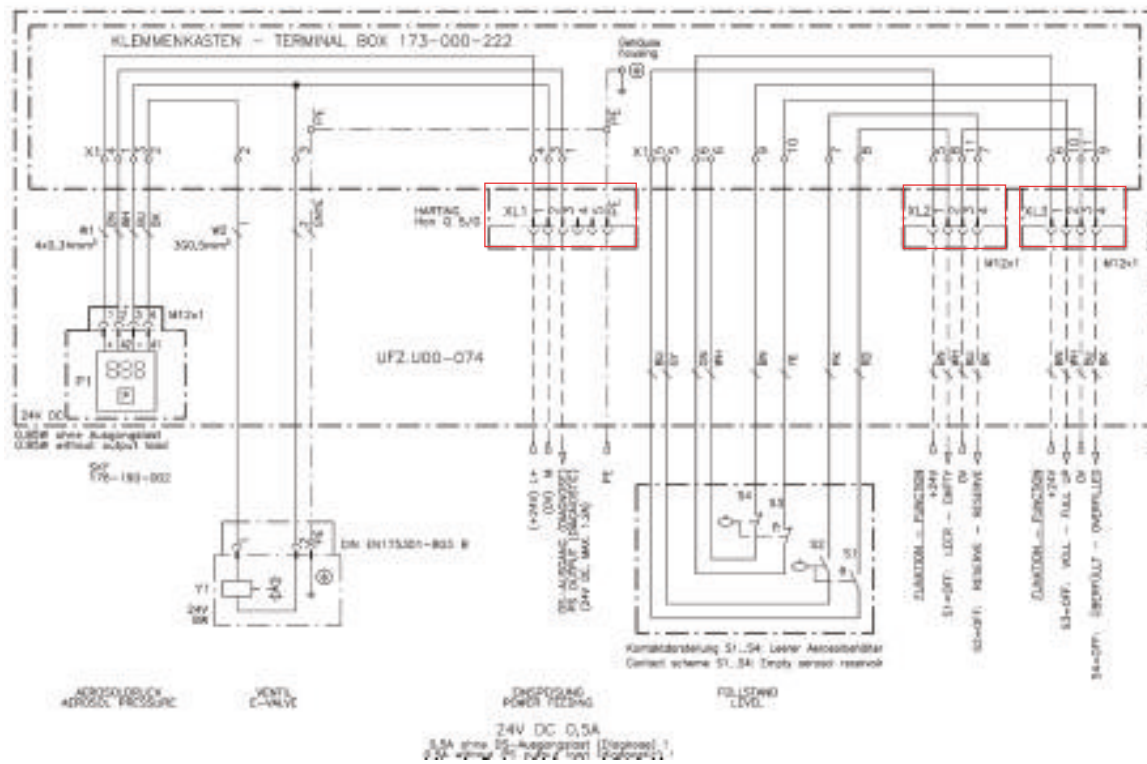

Electronic pressure switch X1, Fig. 12

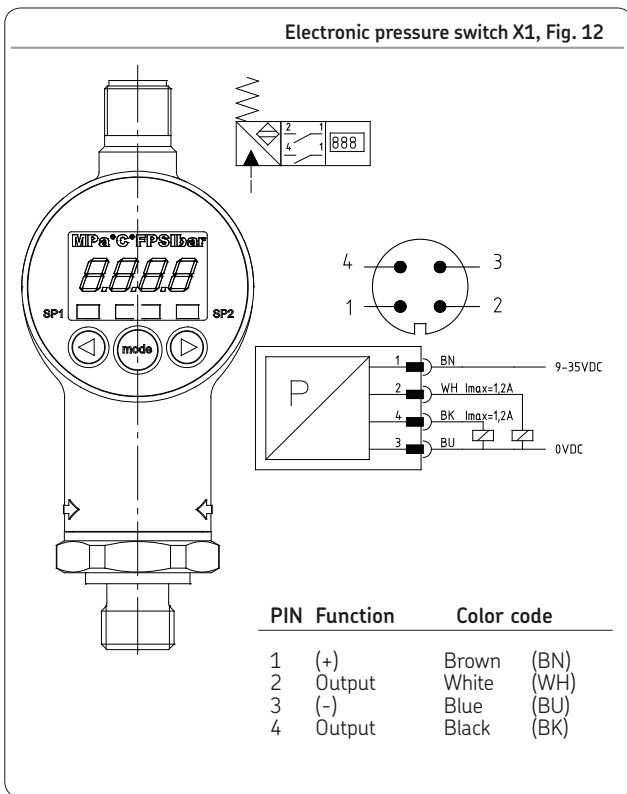

Legend to Fig. 12

**General characteristics**

Rated pressure range:	10 bar
Permissible overpressure:	30 bar
Burst pressure:	>50 bar
Adjustable display:	bar, psi, MPa
Ambient temperature:	-25 to +80°C (-13 °F to + 176 °F)
Temperature of medium:	-25 to +80°C (-13 °F to + 176 °F)
Materials in contact with medium:	Stainless steel; FKM (FPM)

Protection degree and class:

IP67

Vibration resistance:

&lt;10g/0 to 500 Hz

**Deviation from upper limit of effective range**

Accuracy (display):	<±0.5% FS typ <sup>1)</sup>
	<±0.25% FS max.1)
Temperature drift:	<±0.25%/10K

**Electrical characteristics**

Operating voltage:	9 - 35 VDC
Power consumption without switching output:	Max. 35 mA
Current-carrying capacity of signal outputs:	1.2 A
Number of signal outputs:	2
Type of signal outputs:	PNP transistor stages
Electrical connection:	M12x1 connector, 4-pin

1) FS (Full Scale) = relative to the full measuring range

### 4.7.2 Electrical fill level switches (XL2/XL3)

See Figure 13

#### Fill level switch 1

(XL3 upper switch)

- o Device overfilled
- o Maximum fill level

#### Fill level switch 2

(XL2 lower switch)

- o empty
- o reserve

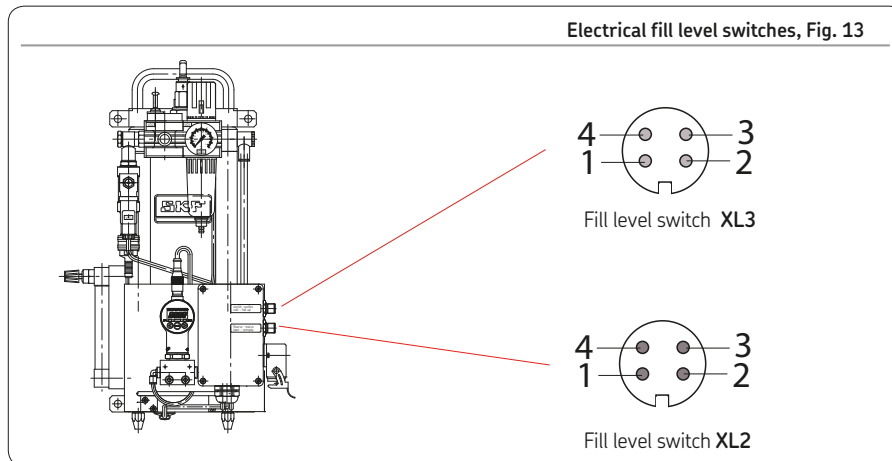

Fill level switch XL3, legend to Fig. 13

Contact	Assignment
Pin 1	+ 24 VDC
Pin 2	Maximum fill level
Pin 3	0 V (GND)
Pin 4	Device overfilled

Fill level switch XL2, legend to Fig. 13

Contact	Assignment
Pin 1	+ 24 VDC
Pin 2	empty
Pin 3	0 V (GND)
Pin 4	reserve

If using a cable set with cable socket, see Chapter 12, "Accessories."

#### 4.8 Note on the rating plate









☞ See Figure 14

The rating plate provides important data such as the type designation, order number, barcode, and serial number.

To avoid loss of this data in case the rating plate becomes illegible, these characteristics should be entered in the following table.

- Enter key data from rating plate in the following Figure 14.

**Key data from rating plate, Fig. 14**

	  Typ - Type :  Bestell-Nr. - Order no. :  Betriebsp. - Operating voltage :  Baujahr - Constr. year :  Serien-Nr. - Serial no. :   Made in Germany

#### 4.8 Notes on the CE marking

The CE marking is performed following the requirements stated in the applied standards:

- 2004/108/EC Electromagnetic Compatibility
- 2011/65/EU (RoHS II) Directive on the restriction of the use of certain hazardous substances in electrical and electronic equipment

#### Notes on the Low Voltage Directive

The protective regulations of the low voltage directive 2014/35/EU are complied with according to annex I, no. 1.5.1 of machinery directive 2006/42/EC.

#### Notes on the Pressure Equipment Directive 2014/68/EU

Due to its performance rates the product does not achieve the limit values fixed in article 4 (1)(a)(i) and is excluded from the scope of the pressure equipment directive 2014/68/EC article 4(3).







## **Vario/VarioPlus of the UFV10-0XX Series**

Minimal Quantity Lubrication for Internal Lubrication

**Operating instructions associated  
with assembly instructions**

## 1. Safety instructions

## 2. Lubricants

### 1.1 General information

#### NOTE

The operator of the product described here must ensure that the operating instructions are read and understood by all persons responsible for assembly, operation, maintenance, and repair of the product. In addition to the operating instructions, general statutory regulations and other regulations for accident prevention and environmental protection must be observed and applied.

#### NOTE

The lubricant notes listed in Chapter 2 "Lubricants" of the assembly instructions also apply without restriction to these operating instructions.

## 3. Delivery, returns, and storage

### 3.1 Checking the delivery

Immediately after receipt, the delivery must be checked for completeness according to the shipping documents. Any transport damage must be reported to the transport company immediately. The packaging material should be preserved until any discrepancies are resolved.

### 3.2 Returns

All parts must be cleaned and properly packed before return shipment (i.e., according to the requirements of the recipient country). There are no restrictions for land, air, or sea transport.

The following must be marked on the packaging of return shipments:

	Do not top load / This side up
	Keep dry
	Handle with care, Do not drop

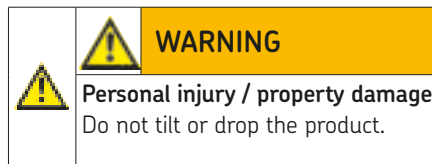

The following conditions apply to storage:

### 3.3 Storage

#### 3.3.1 Lubrication units

- o dry and dust-free surroundings, storage in well ventilated dry area
- o Storage time: Max. 24 months
- o Relative humidity: < 65%
- o Storage temperature: + 10 to +40°C (+ 50 °F to + 104 °F)
- o No direct sun or UV exposure
- o Protected against nearby sources or heat or cold

#### 3.3.2 Electronic and electrical devices

- o Dry and dust-free surroundings, storage in well ventilated dry area
- o Storage time: Max. 24 months
- o Relative humidity: < 65%
- o Storage temperature: + 10 to +40°C (+ 50 °F to + 104 °F)
- o No direct sun or UV exposure
- o Protected against nearby sources or heat or cold

#### 3.3.3 General notes

- o The product(s) can be enveloped in plastic film to provide low-dust storage.
- o Protect against ground moisture by storing on a shelf or wooden pallet.
- o Bare metallic surfaces must be protected using anti-corrosion agents. Check corrosion protection every 6 months and reapply if necessary.

## 4. Assembly

### 4.1 Information on assembly

The assembly procedure for the product is described in detail in the assembly instructions (Chapter 4) associated with these operating instructions.

## 5. Functional description

### 5.1 Principle of minimal quantity lubrication (MQL)

Minimal quantity lubrication (MQL) involves total-loss lubrication, i.e., the lubricant is almost completely consumed during machining so treatment of the lubricant is not required. The actual lubrication is performed at the friction point between the tool and the chips running off in the chip groove. The lubricating effect is achieved by an aerosol, i.e., droplets of lubricant finely dispersed in an air flow. Minimal quantity lubrication provides for effective lubrication of cutting processes using very small amounts of lubricant. The arduous task of cleaning and disposing of large amounts of lubricant and cooling lubricant is greatly simplified or eliminated.

### 5.2 The principle of aerosol action

Aerosol is a mixture of air and lubricant in which air assumes the transfer properties for the lubricant. In terms of the size and distribution of lubricant droplets created, the SKF MQL system described here generates a very homogeneous aerosol with a droplet size of approx. 0.5  $\mu\text{m}$ .

The lubricant droplets are very light due to their small size, which in turn results in a very low moment of inertia. These small droplets of lubricant can be transported over long stretches through lines and deflections without being deposited due to their moment of inertia.

Additionally, the transport of the aerosol through rotating spindles and tools is unproblematic for the MQL systems even at very high rotational speeds, since the effect of centrifugal force on the oil droplets is very low.

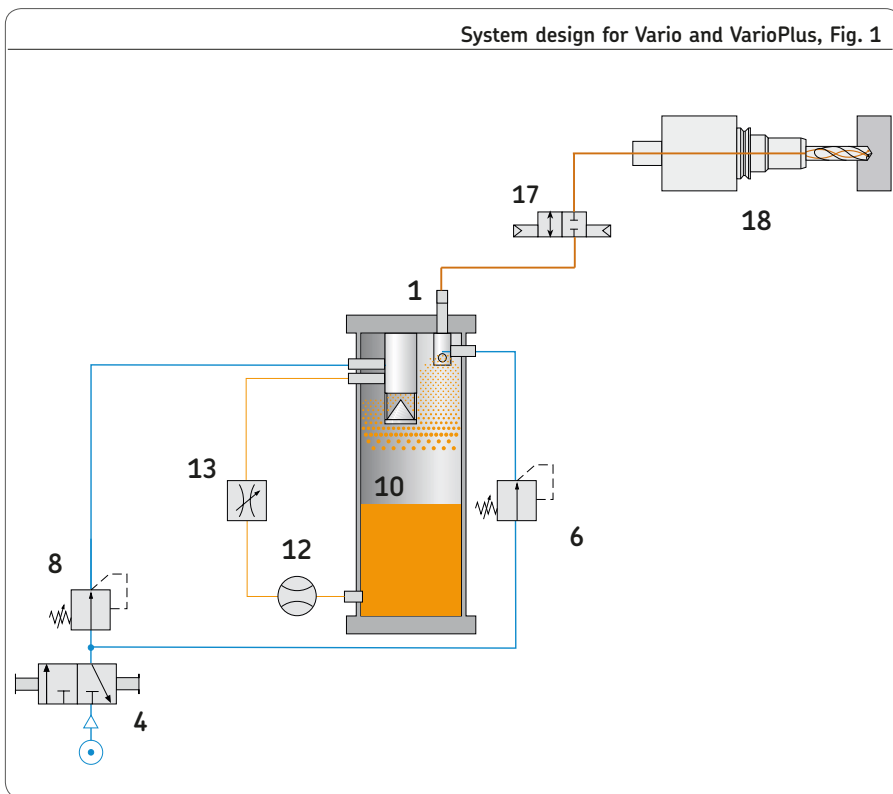

Legend to Fig. 1

Item numbers in connection with Figures 3 and 4.

Item	Assignment
1	Aerosol outputs 1 to 3
4	Main air valve
8	Pressure control valve for primary pressure
13	Oil valve
12	Variable rate flow meter
6	Pressure control valve for auxiliary air (only VarioPlus)
17	Ball valve (optional)
18	Customer-supplied tool

### 5.3 Design of the system

Figure 3 shows the standard version of the Vario minimal quantity lubrication system and Figure 4 shows the standard version of the VarioPlus minimal quantity lubrication system.

The systems differ primarily only in that the aerosol pressure in the VarioPlus is monitored by an electric pressure switch that detects the current pressure in the aerosol generator and manages this pressure internally in the MQL system.

In contrast, the aerosol pressure in the Vario is monitored only visually via a pressure gauge.

Further, the VarioPlus system is equipped with an electric fill level control for fill levels "Maximum," "Device overfilled," "Pre-warning minimum", and "Minimum."

The fill level display for lubricating oil (Figure 2, item 11) is used for visual monitoring.

#### 5.3.1 Vario - Design and function

☞ See Figures 1 to 3

The customer's compressed air is supplied via a mechanical main air valve (4) attached to the aerosol generator or optionally via an electric valve that is actuated via the machine's control unit.

An air supply unit (5) is also installed, consisting of a pressure control valve for auxiliary air (6) and a pressure control valve for primary pressure (8).

The pressure control valve for primary pressure (8) is used to regulate the aerosol flow, while the pressure control valve for auxiliary air (6) further accelerates the aerosol flow to the tool. Both pressure control valves are equipped with a pressure gauge (7/9).

The aerosol generator (10) is filled with lubricant via a fillport that is equipped with a screw plug (3) and positioned on the reservoir lid.

A fill level indicator for lubricant (11) is located on the side of the aerosol generator (10).

It can be used to directly read the lubricant level. The minimum and maximum levels

are indicated by markings on the aerosol generator.

The quantity of oil is set using the setting screw on the oil valve (13) attached to the output of the variable rate flow meter (12).

The lubricant flow rate can be determined based on the level of the float (12) in the glass tube and set using the oil valve (13). The float is read from its horizontal diameter (mid-ball); see Figure 2.

The aerosol exits towards the tool via one of the three aerosol outlets (1) on the reservoir lid. The outlet is selected according to the customer's specific situation.

### Principle of operation

☞ See Figures 1 and 2

The compressed air (primary air) entering through the main air valve (4) is forwarded through the downstream pressure control valve (8) into the aerosol generator (10), where it pressurizes the lubricating oil in the reservoir.

The lubricating oil, which has now been pressurized, flows through the variable flow rate meter indicator (12) to the oil valve (13).

The oil valve (13) controls the quantity of lubricant flowing into the upper portion of the aerosol generator (10), where it mixes with the constant inflow of primary air to form an aerosol mixture.

The aerosol flow is controlled by the pressure control valve (8).

This valve is operated manually and is continuously adjustable.

If needed, further acceleration of the aerosol flow can be achieved via the pressure valve for auxiliary air (6).

Note that the addition of auxiliary air modifies the composition of the aerosol by reducing the proportion of lubricant.

The aerosol is passed on from the aerosol outlets (1) mounted to the reservoir lid. From there, the aerosol flows to the tool through the customer's aerosol line.

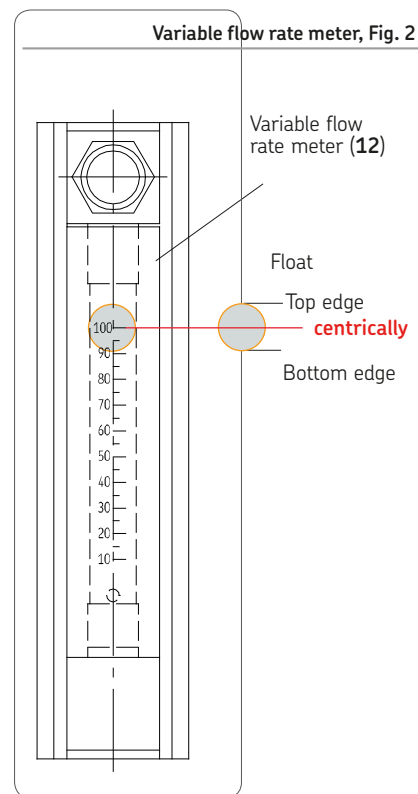

Overview of standard Vario version, Fig. 3

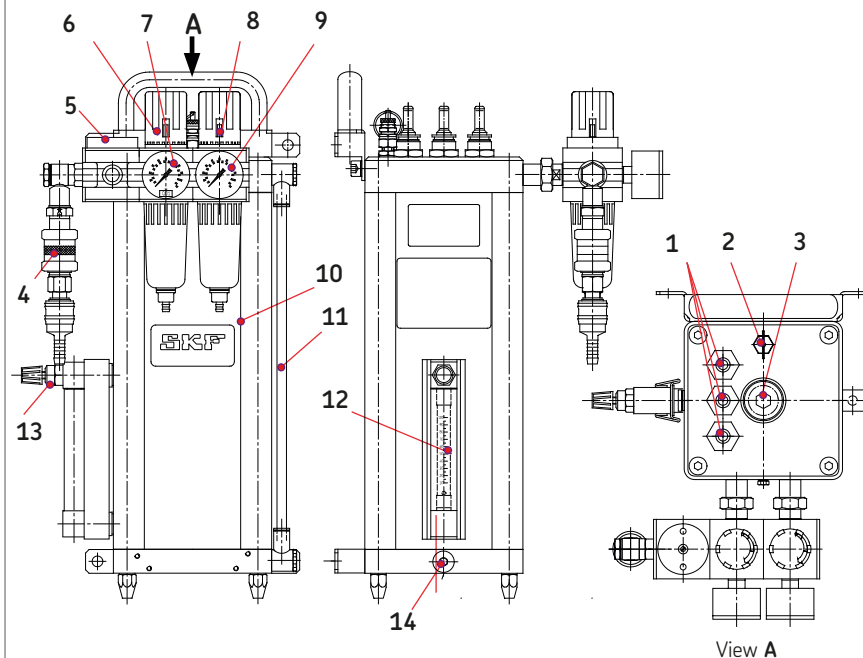

Item	Description
1	Aerosol outlets (3x)
2	Pressure relief valve (12 bar)
3	Screw plug for lubricant fillport, optionally with check valve
4	Main air valve with compressed air connection port (nom. size 7-8 mm)
5	Air supply unit
6	(Rotary knob) pressure control valve for auxiliary air
7	Pressure gauge for auxiliary air pressure
8	(Rotary knob) pressure control valve for primary pressure
9	Pressure gauge for primary air pressure
10	Aerosol generator
11	Lubricating oil fill level indicator
12	Variable rate flow meter
13	Oil valve setting screw
14	Oil drain plug



### 5.3.2 VarioPlus - Design and function

☞ See Figure 4

The customer's compressed air is supplied via an electric main air valve (4) that is actuated via the machine's control unit.

An air supply unit (5) consisting of a pressure control valve for primary pressure (6) is located downstream of the main valve (4).

The airflow rate for the aerosol generator is set using the pressure control valve for primary pressure (6).

The pressure control valve is equipped with a pressure gauge (7).

The aerosol generator is filled with lubricant via a fillport that is equipped with a screw plug (3) and positioned on the reservoir lid.

A pressure-reducing valve can be installed in place of the screw plug (3).

A fill level indicator for lubricant (9) is located on the side of the aerosol generator (8). It can be used to directly read the lubricant level. The minimum and maximum levels are indicated by markings on the aerosol generator.

The quantity of oil is set using the setting screw on the oil valve (15) attached to the output of the variable rate flow meter (10).

The lubricant flow rate can be determined and set based on the level of the float in the glass tube. The float is read from its horizontal diameter (mid-ball). The aerosol pressure built up in the aerosol generator is detected by a digital pressure switch (14).

The internal pressure in the reservoir is measured during operation. The compressed air supply is shut off and no more aerosol is produced when the pressure difference exceeds a certain factory-set value, for example, due to the use of a tool with a very small cooling duct cross-section.

Aerosol which has already been produced drains off. Aerosol generation is resumed as soon as the differential pressure falls again below a the factory-set value. This process is known as "cycling" and is audible during operation.

The pressure switch is factory-set for a 6 bar air pressure supply.

Two filling level switches (11/12) in the aerosol generator monitor the lubricant volume inside the reservoir. The lower switch (12) handles the monitoring functions of "Pre-warning minimum" and "Minimum", the upper switch (11) handles the functions "Device overfilled" and "Maximum filling level." Data is transferred to the machine tool's control unit via a connector socket for each switch.

The aerosol exits towards the tool through the three aerosol outlets (1) on the reservoir lid.

### Principle of operation

☞ See Figures 1 and 2

The compressed air (primary air) entering through the main air valve (4) is forwarded through the downstream pressure control valve (8) into the aerosol generator (10), where it pressurizes the lubricating oil in the reservoir.

The lubricating oil, which has now been pressurized, flows through the variable flow rate meter indicator (12) to the oil valve (13).

The oil valve (13) controls the quantity of lubricant flowing into the upper portion of the aerosol generator (10), where it mixes with the constant inflow of primary air to form an aerosol mixture.

The aerosol flow is controlled by the pressure control valve (8).

This valve is operated manually and is continuously adjustable.

The aerosol pressure is monitored by an electronic pressure switch that detects the current pressure in the aerosol generator and that determines the current pressure in the aerosol generator and regulates it to the fixed values.

Overview of standard VarioPlus version, Fig. 4

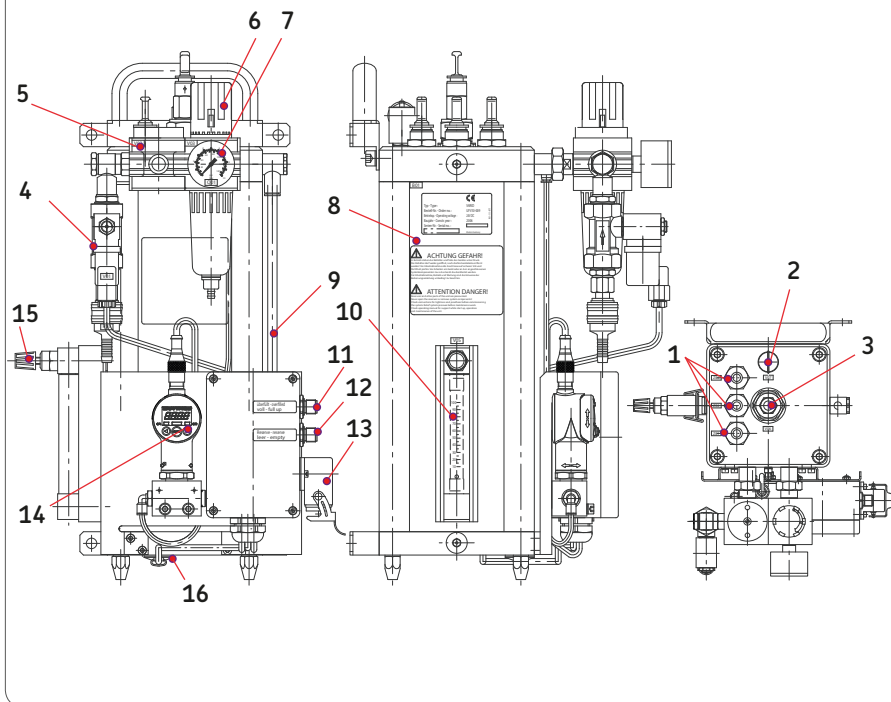

Item	Description
1	Aerosol outlets (3x)
2	Pressure relief valve (12 bar)
3	Screw plug for lubricant fillport, optionally with check valve
4	Main air valve, optionally with electric shut-off valve and/or compressed air connection port (nom. size 7-8 mm)
5	Air supply unit
6	Pressure control valve for primary pressure
7	Pressure gauge for compressed air primary pressure
8	Aerosol generator
9	Lubricating oil fill level indicator
10	Variable rate flow meter
11	Connection for fill level monitoring, switch 1
12	Connection for fill level monitoring, switch 2
13	Connector socket for items 4 and 14
14	Electronic pressure switch
15	Oil valve setting screw
16	Oil drain plug

## 6. Commissioning

### NOTE

Only fill using clean lubricant and an appropriate device. Contaminated lubricants lead to system malfunctions.

### 6.1 General information

The optimal configuration for the Vario and VarioPlus MQL systems depends on a variety of factors such as the primary pressure applied, the length of the aerosol transport lines, the type and size of the tool, as well as the cooling duct cross-section and the machining process. It is therefore not possible to predefine the setting parameters required to the particular machining situation.

The setting parameters shown in Figure 5 are reference values and are intended to provide general orientation for configuring the MQL system for the customer's specific application.

In order to achieve the optimal results for the customer's machining process, the required settings must be ascertained and optimized on the basis of test runs. After an extended machine downtime or a tool replacement, there may be temporary discontinuities in aerosol feeding at the lubrication point and an oil mist may form. During operation the aerosol supply stabilizes again and a possible oil mist disappears.

### 6.2 Effects of primary pressure

The Vario and VarioPlus MQL systems draw the power required for aerosol generation from the compressed air supplied to the system.

The systems are ready for operation and generate an aerosol adequate for most lubrication tasks at a primary pressure of 6 bar. The compressed air supply controlled by differential pressure can also ensure adequate lubricant supply to small tools. However, the systems only reach peak performance at or beyond a **primary pressure of 8 bar**.

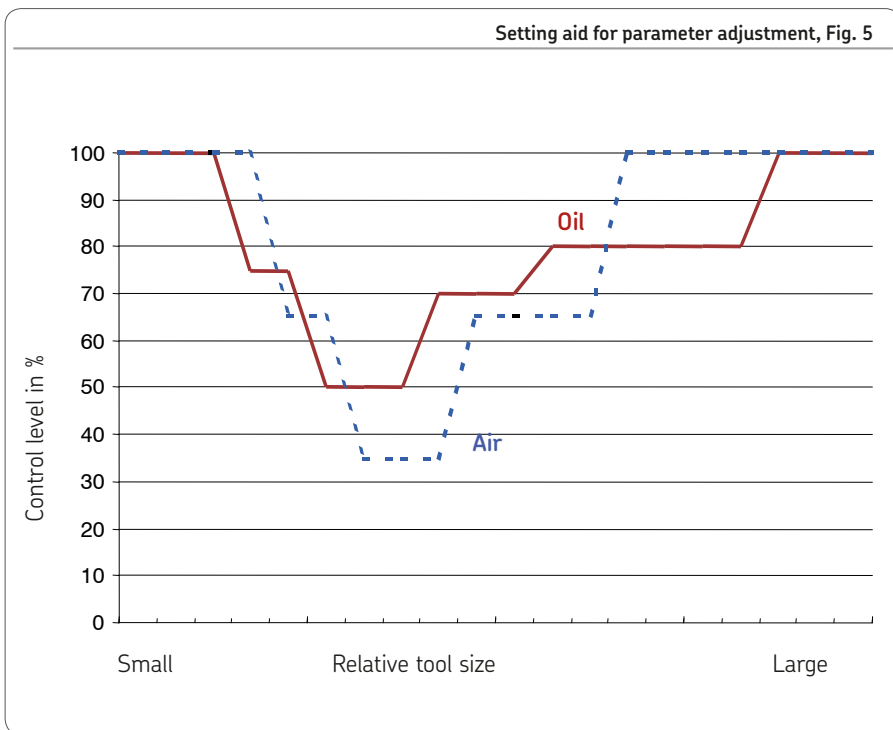

## 6.2 Commissioning

Before commissioning the MQL system, the Vario or VarioPlus MQL system must be connected according to the enclosed assembly instructions, Chapter 4.

In particular, the following operating must have been conducted and fully completed:

- o Assembly instructions, Chapter 4.5, Initial filling of the MQL system (Vario or VarioPlus)
- o Assembly instructions, Chapter 4.6 Compressed air connection port
- o The customer's compressed air supply must be set to a continuous primary pressure of 8 bar.
- o Observe the requirements for the supplied compressed air; see Table 1 in the assembly instructions.

### 6.2.1 Commissioning the Vario

☞ See Figure 3

- Remove the customer's tool from the toolholder.
- Open the main air valve (4).

☞ No aerosol is produced when the main air valve is closed.

- Set the pressure control valve (8) to a primary pressure of 6 bar using the pressure gauge (9).

☞ To open the pressure control valve (8) (increase volume), lift the rotary knob on the pressure valve and then turn it clockwise. The set value can be read on the pressure gauge display (9). To close the pressure control valve (9) (decrease volume), lift the rotary knob and then turn it counterclockwise. The set value can be read on the pressure gauge display (8).

- Use the oil valve setting screw (13) and variable flow rate meter (12) to set the lubricant flow to 100%.
- Check whether the aerosol discharges freely from the toolholder.

☞ The aerosol must emerge visibly from the duct system.

- Clamp the customer's tool back into the toolholder.
- Hold an oil-free workpiece approx. 1 to 3 mm below the outlet duct of the clamped tool.

☞ If no lubricant film forms on

the workpiece surface, there is a fault in the tool's duct system. In this case, perform an aerosol flow check on the tool and the toolholder.

- If necessary, adjust the flow velocity of the aerosol using the pressure control valve for auxiliary air (6) and the pressure gauge for auxiliary air (7).

#### For a rotating tool:

- firmly clamp the smooth, oil-free plate to the machine table without impacting the tool.

- Move the rotating tool until it is approx. 1 to 3 mm above the oil-free plate.

☞ If no lubricant film forms on the workpiece surface, there is a fault in the tool's duct system.

In this case, perform an aerosol flow check on the tool and the toolholder.

- Move the tool forward horizontally at approx. 0.6 m/min.

☞ A closed lubricant film

with a width of approximately double that of the tool diameter should then be visible on the plate.

- Adapt the aerosol mixture and quantity of aerosol to the machining process until the machining results meet requirements (using the oil valve **(13)**, pressure control valve **(8)**, and pressure control valve for auxiliary air **(6)**).

☞ SKF recommends that the settings be noted so that they can be reused easily at any time.

### 6.2.2 Commissioning the VarioPlus

☞ See Figures 2 and 4

- Remove the customer's tool from the toolholder.

- Open the main air valve (4).

☞ No aerosol is produced when the main air valve is closed.

- Set the pressure control valve (6) to a primary pressure of 6 bar using the pressure gauge (7).

☞ To open the pressure control valve (6) (increase volume), lift the rotary knob on the pressure valve and then turn it clockwise. The set value can be read on the pressure gauge display (7). To close the pressure control valve (6) (reduce volume), lift the rotary knob and then turn it counter-clockwise. The set value can be read on the pressure gauge display (7).

- Use the oil valve setting screw (15) and variable flow rate meter (10) to set the lubricant flow to 100%.
- Check whether aerosol discharges freely from the cooling duct of the tool clamping system.

☞ The aerosol must emerge visibly from the duct system.

- Clamp the customer's tool back into the toolholder.
- Hold an oil-free workpiece approx. 1 to 3 mm below the outlet duct of the clamped tool.

☞ If no lubricant film forms on the workpiece surface, there is a fault in the tool's duct system. In this case, perform an aerosol flow check on the tool and the toolholder.

#### For a rotating tool:

- firmly clamp the smooth, oil-free plate to the machine table without impacting the tool.
- Move the rotating tool until it is approx. 1 to 3 mm above the oil-free plate.

☞ If no lubricant film forms on the plate surface, there is a fault in the tool's duct system. In this case, perform an aerosol flow check on the tool and the toolholder.

- Perform test runs and, if necessary, increase or reduce the aerosol quantity using the pressure valve (6).
- Adjust the differential pressure switch if necessary.



### 6.3 Electronic pressure switch

The VarioPlus MQL system is equipped with an electronic pressure switch that detects the current pressure in the aerosol generator and manages this pressure internally in the MQL system.

Depending on the design, the device offers the following functions:

- o Display of the current measured pressure in PSI, MPa, and bar
- o Display of a set switching point
- o Actuation of switching points according to pressure and the set switching parameters
- o Diagnostic signal to query the status of the pressure switch
- o Menu for basic settings (adjustment of the pressure switch to the particular application)
- o Programming releases

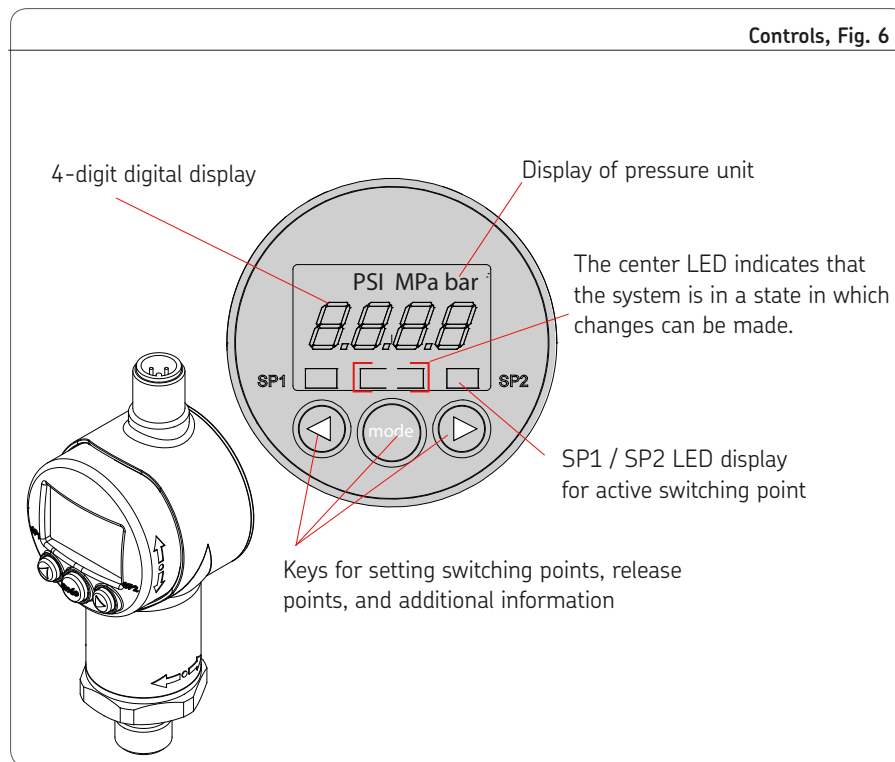

### 6.3.1 Digital display

After the supply voltage is switched on, the device briefly displays "EdS" and begins displaying the current pressure (basic setting).

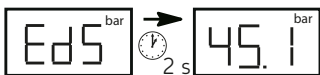

The display can be modified in the basic settings as follows:

- o Display of the set switching point  
"S.P. 1", "S.P. 2"  
Depending on the design, switching point 1 or switching point 2 can be displayed constantly.
- o Display is dark "oFF"  
The display is off.
- ☞ The display cannot show the current pressure if it exceeds the device's rated pressure. In this case, the display will start to flash.
- ☞ 0 bar is displayed if the current pressure is below 0.75% of the rated pressure range.

### 6.3.2 Output characteristics

#### Switching outputs

The EDS 3000 is equipped with 1 switching output and a diagnostic output (operating modes: "SPAn" and "diAG") or 2 switching outputs (operating mode: "2SP") depending on the setting in the basic settings menu. The following switching characteristics can be set in the basic settings for operating modes "diAG" and "2SP":

#### Setting for switching point (SP)

Settings in "SPAn" mode.

A switching point can be set for the switching output. The hysteresis in this mode is non-adjustable as 0.5% FS (at 10 bar: 0.06 bar; at 250 bar: 1.5 bar; at 400 bar: 2 bar and at 600 bar: 3 bar). The output switches once the set switching point is reached and switches back if the value falls below the release point. The release point is defined by the set hysteresis

(release point = switching point minus hysteresis).

Abbreviation: "S.P.1" = switching point 1

#### Settings in "diAG" mode

A switching point and a hysteresis can be set for the switching output. The output switches once the set switching point is reached and switches back if the value falls below the release point. The release point is defined by the set hysteresis

(release point = switching point minus hysteresis).

Abbreviations: "S.P.1" = switching point 1  
"HyS.1" = hysteresis 1

#### Settings in "2SP" mode

A switching point and a hysteresis can be set for each switching output. The respective output switches once the set switching point is reached and switches back if the value falls below the release point. The release point is defined by the set hysteresis

(release point = switching point minus hysteresis).

**Abbreviations:**

"S.P.1", "S.P.2" = switching point 1 or 2

"HyS.1", "HyS.2" = hysteresis 1 or 2

(for example, triggered by pulsations of a pump).

**6.3.3 Setting for window function (WIN)**

The window function permits monitoring of a range. An upper and a lower switching value defining the range can be entered for each switching output. The respective output switches if the pressure enters this range. The output releases if the pressure leaves this range. The lower release value is slightly below the lower switching value (lower switching value minus 3 times the increment; see Chapter 6.3.4). The upper release value is slightly above the upper switching value (upper switching value plus 3 times the increment; see Chapter 6.3.4).

The area between the switching and release point values forms a safety zone that prevents undesired switching operations

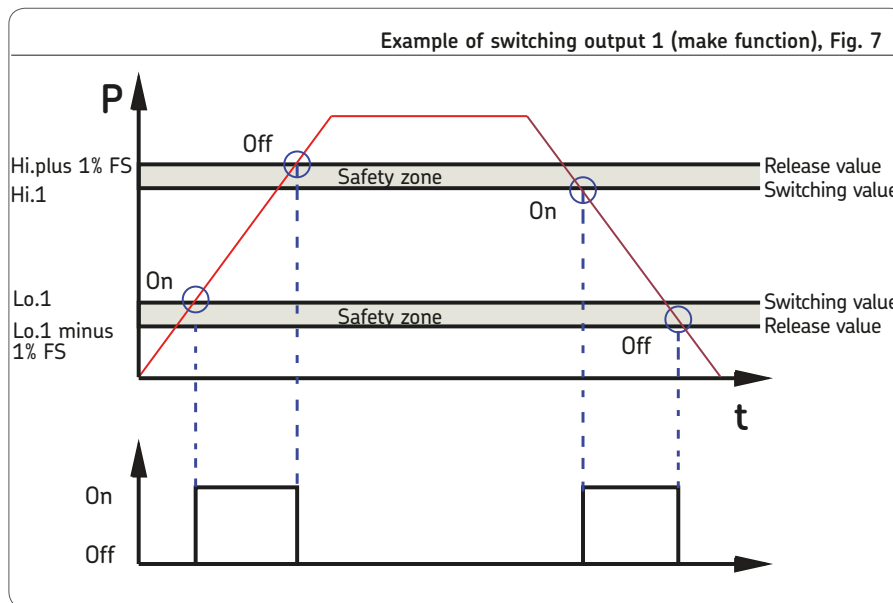

Abbreviations:

"HI 1", "HI 2" = High level 1 or 2 =  
upper switching point 1 or 2

"Lo 1", "Lo 2" = Low level 1 or 2 =  
lower switching point 1 or 2

"FS" (Full Scale) = relative to the full measuring range

☞ The window function only works properly (switches on and off) if all switching points (including the safety zone) are greater than 0 bar and less than the rated pressure range.

### 6.3.4 Setting switching points and hystereses or switching points for the window function

- Simultaneously press the keys ◀ and ▶
- ☞ The display shows "Free".
- Press the "mode" key to select the desired parameter.
  - ☞ (if the switching point function is set, "S.P.1", "hYS.1", "S.P.2", or "hYS.2" appear; if the window function (WIN) is set, "Hi.1", "Lo.1", "Hi.2" or "Lo.2" appears)
  - ☞ The current setting flashes after 2 seconds.
- Change the setting using the ◀ and ▶ keys.
- Additional parameters can be selected using the "mode" key and the setting can be changed using the ◀ and ▶ keys.

☞ Pressing the "mode" key saves the settings. If no key is pressed within 2 minutes, the device will return to normal pressure switch mode without saving the changed values. Key operation is locked at the same time.

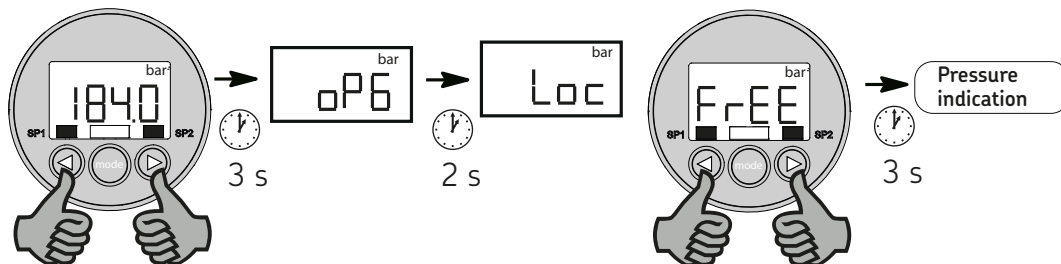

- Simultaneously press both arrow keys and hold them for 3 seconds.
  - Release the arrow keys as soon as this display appears.
  - Change settings using ◀ or ▶.
- FrEE = Program is free  
Loc = Program is locked

### 6.3.5 Setting the switching point in "diAG" and "2PS" modes

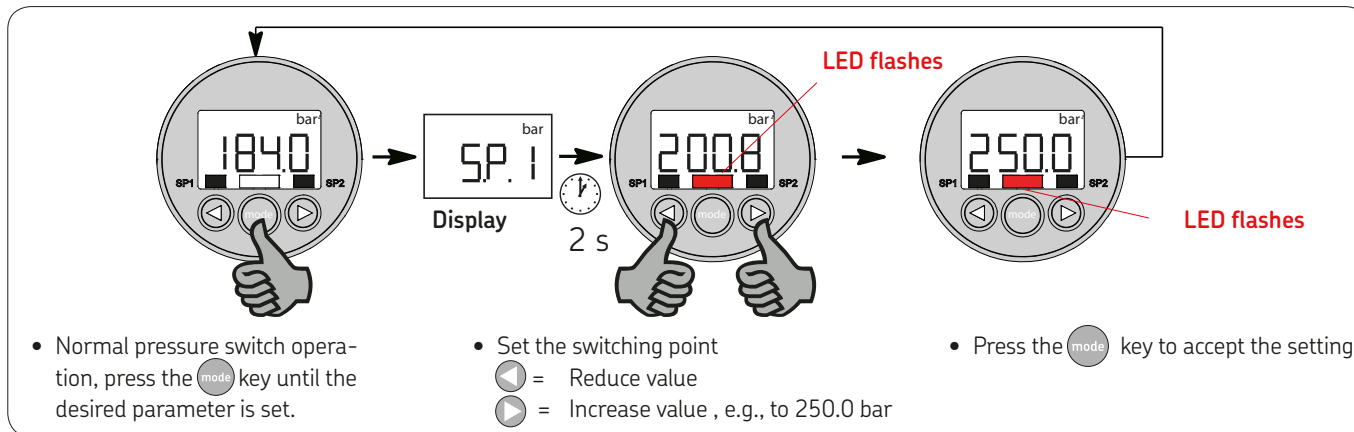

☞ If "LOC" appears in the display while attempting to configure, it indicates that programming is locked.

**Remedy:** Set programming release(s) to "free". (see the "Programming releases" chapter)

- Pressing and holding the ◀ or ▶ key while changing the value causes it to be automatically incremented.
- If a setting has been changed, "PRG" appears briefly when switching the display. The new setting has been stored in the device.

## 6.3.6 Setting the switching point in "Hys1" mode

• Normal pressure switch operation, press the **mode** key until the desired parameter is set.

• Set the switching point  
 ◀ = Reduce value  
 ▶ = Increase value , e.g., to 250.0 bar

• Press the **mode** key to accept the setting.

☞ If "LOC" appears in the display while attempting to configure, it indicates that programming is locked. **Remedy:** Set programming release(s) to "free". (see the "Programming releases" chapter)

- Pressing and holding the ◀ or ▶ key while changing the value causes it to be automatically incremented.
- The display shows "PRG" when a change is made, then the new data is stored.

Table 1

Primary air pressure [bar]	Switching point [SP1]	Hysteresis [bar]
6	4	0.6
7	5	
8	6	
9	7	
10	8	

### 6.3.7 Setting ranges for switching outputs

Setting ranges, Table 2

Measuring range [bar]	Switching point or upper switching value [bar]	Hysteresis or lower switching value [bar]	Increment [bar]
-1 to 1	-0.97 to 1	-0.99 to 0.98	0.01
0 to 10	0.16 to 10	0.06 to 9.9	0.02
0 to 250	4 to 250	1.5 to 247.5	0.5
0 to 400	6 to 400	2 to 396	1
0 to 600	9 to 600	3 to 594	1



All ranges listed in the table can be adjusted in the increments shown.

By default, all values for switching points and hystereses ("**S.P.1**"; "**HYS.1**"; "**S.P.2**" and "**HYS.2**") are set to the minimum value.

Both switching outputs are "open" when the minimum values are set. The values can be set in the ranges indicated above. Values between minimum values for the measuring range and the minimum possible values for the setting ranges of switching points and

hystereses can be selected but cause error message "**E.01**" on the pressure switch.

This error message can be corrected by selecting values greater than the minimum limit of the setting ranges.



## 6.4 Basic settings of the electronic pressure switch

The characteristics of the electronic pressure switch can be modified using several basic settings to adapt to the particular situation. These are combined in one menu.

### 6.4.1 Changing the basic setting

☞ No switching functions are executed while the menu is active!

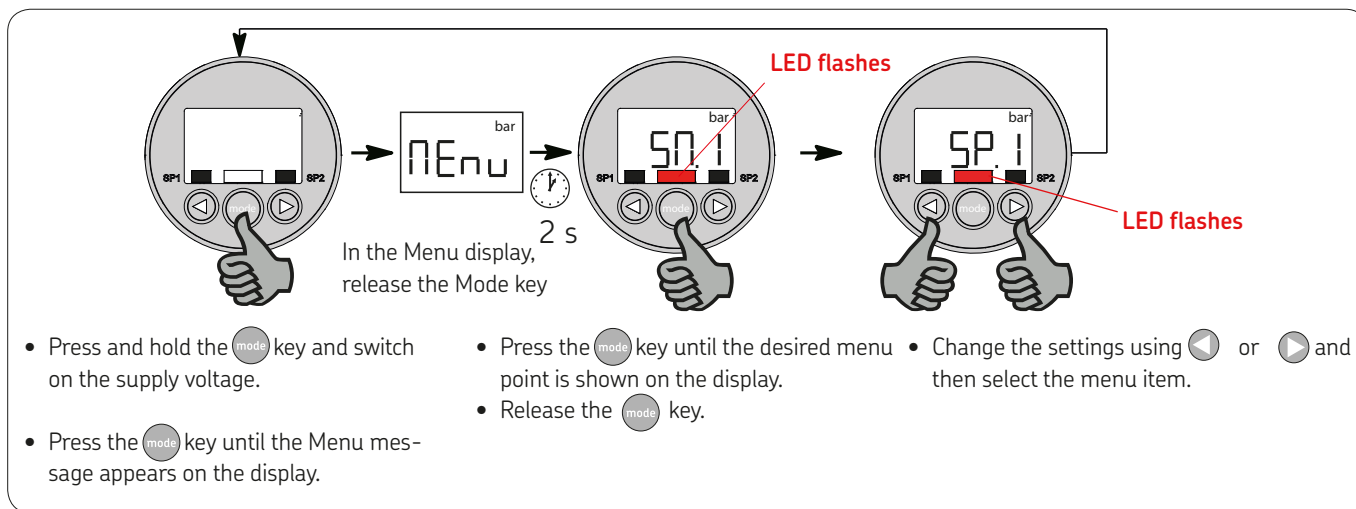

### 6.4.2 Ending the basic setting



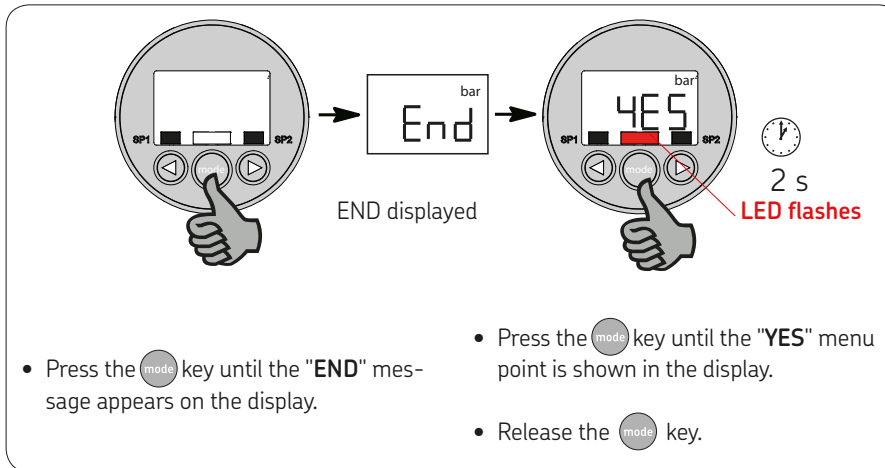





☞ No switching functions are executed while the menu is active!

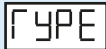

☞ The middle LED starts blinking when you enter the basic settings menu. If no key is pressed after 2 minutes, the device will return to normal pressure switch mode without saving the changed values. The flashing frequency increases 20 seconds before this time expires.

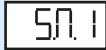
## 6.4.3 Overview of basic settings

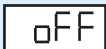

Overview of basic settings, Table 2

Setting		Display	Adjustment range	Default
<b>Operating mode (TYPE)</b>				
  	<p>1 switching output, 1 diagnostic output with non-adjustable hysteresis (0.5% FS), hydraulic clamping mode</p> <p>1 switching output, 1 diagnostic output, diagnostic mode</p> <p>2 switching outputs</p>		SPn / diAG / 2SP	SPAn
<b>Switching mode of switching output 1 (Sm 1)</b>				
 	<p>Switching output 1 operates in hysteresis function switching point</p> <p>Switching output 1 operates in window function</p>		SP / Win	SP
<b>Switching direction of switching output 1 (S 1)</b>				
 	<p>Make function</p> <p>Break function</p>		ON / OFF	ON

Overview of basic settings, Table 3

Setting		Display	Adjustment range	Default
<b>ON delay for switching output 1 (<math>T_{on 1}</math>)</b>				
The time (in seconds) that the switching point must be reached or exceeded in order for a switching operation to be performed			0.00 to 99.99s	0
<b>OFF delay for switching point 1 (<math>T_{off 1}</math>)</b>				
The time (in seconds) during which the value must be below the respective release point in order for a switching operation to be performed			0.00 to 99.99s	0
<b>Switching mode of switching output 2 (<math>S_m 2</math>)</b> The setting can be made only in "2SP" mode.				
	Switching output 2 operates in the hysteresis function switching point		SP / Win	SP
	Switching output 2 operates in window function			
<b>Switching mode of switching output 2 (<math>S_m 2</math>)</b> The setting can be made only in "2SP" mode.				
	Make function		ON / OFF	ON
	Break function			

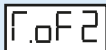
Overview of basic settings, Table 4

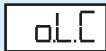
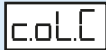





Setting	Display	Adjustment range	Default
<b>ON delay for switching output 2 (<math>T_{on 2}</math>)</b> The setting can be made only in "2SP" mode.			
The time (in seconds) that the switching point must be reached or exceeded in order for a switching operation to be performed		0.00 to 99.99s	0
<b>OFF delay for switching point 1 (<math>T_{off 2}</math>)</b>			
The time (in seconds) during which the value must be below the respective release point in order for a switching operation to be performed		0.00 to 99.99s	0
<b>Overload limit (oL.L)</b>			
Adjustable pressure limit above which overpressure is detected		55%FS to FullScale	Full Scale
<b>Overload counter (oL.c)</b>			
Counter that adds up the number of overloads		0 to 9999	0
<b>Reset overload counter (r.oL.c)</b>			
Overload counter can be reset by selecting "YES".		YES / No	YES

## 6.4.4 Overview of setting options

Overview of basic settings, Table 5

Setting		Display	Adjustment range	Default
<b>ON delay (T.Err)</b>				
Set the delay time for switching off the switching outputs when the overload limit is exceeded. Increment setting: 0.01 s			0.00 to . 9999 s	2.00 s
<b>Error message (Err.M)</b>				
 	This causes the outputs to switch to "low" when overload is detected while operating with 2 switching points "SP". When operating in "SPAn" and "diAG", the diagnostic output is set to low and overload detection does not affect an output.		on / off	off
<b>Primary display (Primary)</b> Value that should be constantly shown in the display:				
 or:   	Current pressure Switching point 1 or 2  Display is dark		ACT/ S.P.1/ S.P.2/ OFF	ACT

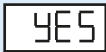
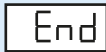
Overview of basic settings, Table 6

Setting		Display	Adjustment range	Default
<b>Set the display range (RANGE)</b>				
When switching between bar, PSI, and MPa, the EDS 3000 automatically scales the switching settings to the newly selected unit.				
	The pressure is displayed in bar.		BAR/ PSI/ MPa	BAR
	The pressure is displayed in PSI.			
	The pressure is displayed in MPa.			
<b>Version number (version)</b>				
Displays the current software version (for viewing only).				
<b>End the basic setting (End)</b>				
	Leave the basic settings menu.		YES/ NO	NO
	The basic settings can continue to be edited.			

## 6.5 Programming releases

If the basic settings have been modified, the message **"ProG"** appears briefly when leaving the basic settings and then the value selected in primary display is shown.

If an internal error occurs during operation (e.g., the measuring cell fails), all switching outputs are set to the value **"0"** and the diagnostic outputs report an error. The error cannot be acknowledged during operation.

The device has 2 programming releases, both of which must be issued in order to change settings. The operational programming release can be set or canceled during operation. It protects against unintentional changes. Locking programming using the main programming releases makes it impossible to modify the settings during operation. This is used, for example, as a safety

function or to protect against unauthorized changes.

### 6.5.1 Changing the operational programming releases

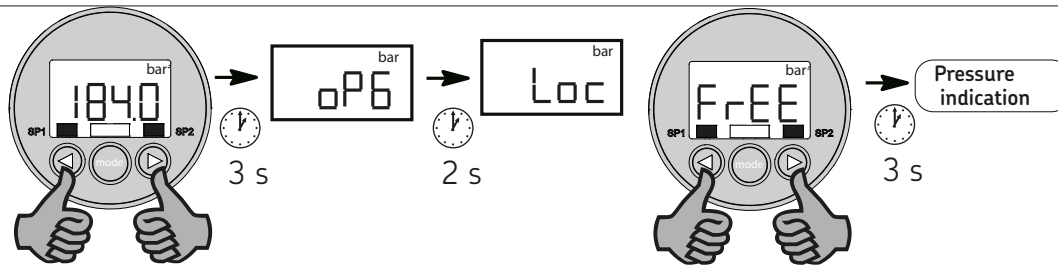

- Simultaneously press both arrow keys and hold them for 3 seconds.

- Release the arrow keys as soon as this display appears.

- Change settings using ◀ or ▶.
- FrEE = Program is free
- Loc = Program is locked



## 6.5.2 Changing the main programming releases

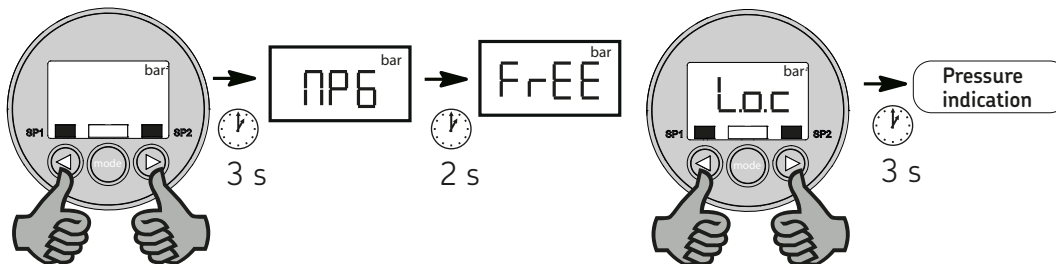

- Simultaneously press both arrow keys and hold them for 3 seconds.
  - Release the arrow keys as soon as this display appears.
  - Change settings using ◀ or ▶.
- FrEE = Program is free  
Loc = Program is locked



If the pressure switch is in the programming release menu, the middle LED flashes constantly. If a setting has been changed, "ProG" appears briefly when switching the display. The new setting has been stored in the device.

## 6.6 Pin assignment

Pin assignment of the pressure switch, Fig. 8

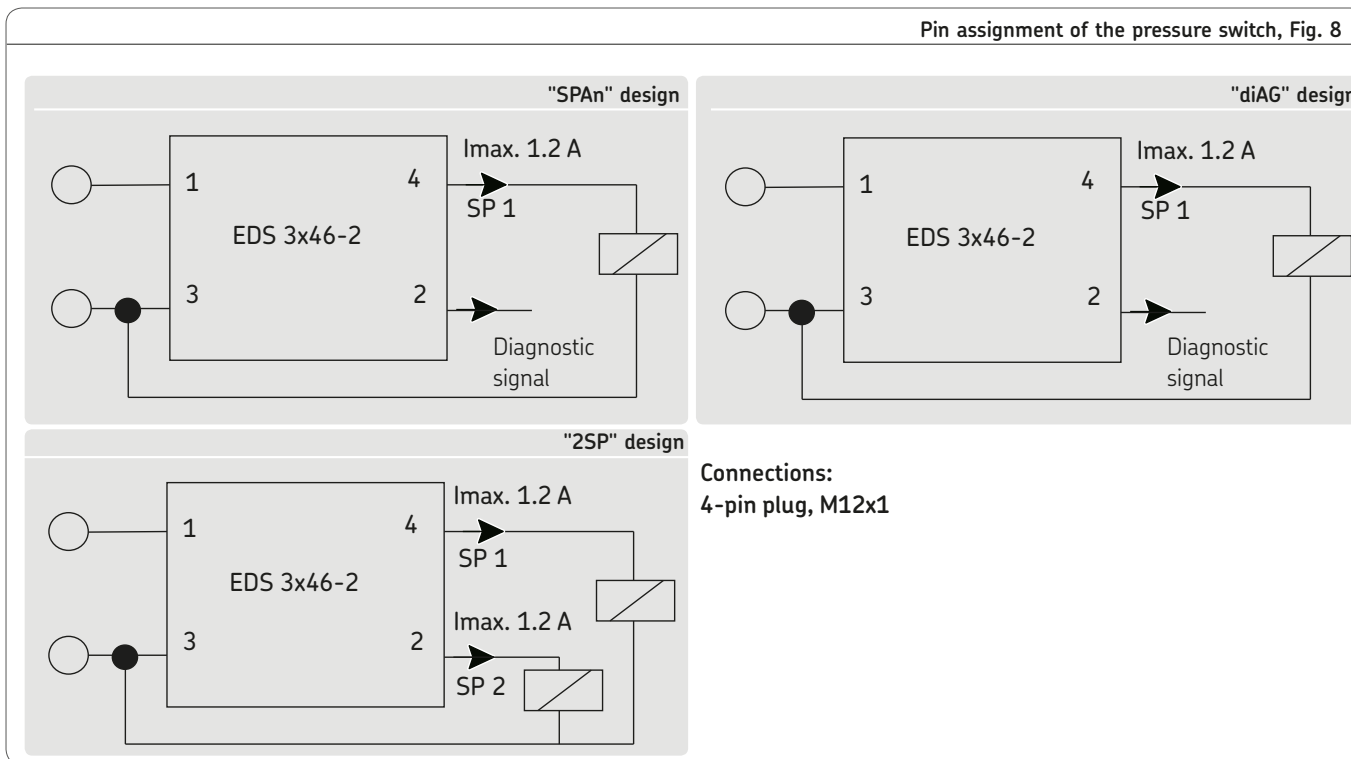

## 7. Operation/decommissioning and disposal

### NOTE

Only lubricants provided by SKF may be used (see the assembly instructions, Chapter 2.3.1 - Approved lubricants). SKF will not accept claims for damages resulting from the use of lubricants other than those approved by SKF.

### NOTE

Only fill using clean lubricant and an appropriate device. Contaminated lubricants lead to system malfunctions.

### 7.1 Operation

The products described here function automatically. The lubricant transport in the aerosol line should, however, be subjected to regular visual inspection.

The lubricant fill level in the aerosol generator should be subjected to visual inspection on a regular basis. If the lubricant fill level is too low, lubricant needs to be topped up.



### NOTE

**Escaping aerosol, wear goggles**  
Aerosol may escape during subsequent work.

### 7.2 Temporary shutdown

If the MQL system will be shut down temporarily, separate the entire system from the compressed air supply and depressurize the reservoir. Additionally, the system must be disconnected from operating voltage and properly protected against restarting and direct contact.

In case of an extended shutdown, it is recommended that the lubricant also be drained. Follow the instructions in the "Assembly" chapter.

Also follow the instructions in Chapter "Transport, delivery, and storage."

### 7.3 Decommissioning and disposal

If the product will be permanently shut down, the local regulations and laws regarding the disposal of contaminated equipment must be observed.

The product can also be returned to SKF Lubrication Systems Germany GmbH for disposal, in which case the customer is responsible for reimbursing the costs incurred. The parts are recyclable.



#### NOTE



##### **Environmental pollution**

Lubricants can contaminate soil and waterways. Lubricants must be used and disposed of properly. Observe the applicable regulations and laws regarding the disposal of lubricants.

## 8. Maintenance

### 8.1 General information

		<b>WARNING</b>
	<b>System pressure</b> Depressurize the aerosol generator before starting maintenance work (see Chapter 8.2.1).	

		<b>WARNING</b>
	<b>Electric shock</b> Assembly, maintenance and repair work may only be performed on products that have been de-energized by qualified technical personnel. The supply voltage must be switched off before opening any of the product's components.	

SKF products are low-maintenance. All connections and fittings must be regularly inspected for proper seating to ensure proper function. If necessary, the product's exterior can be cleaned using mild cleaning agents that are compatible with the product's materials (non-alkaline, non-soap).

For safety reasons, the product should be disconnected from the power supply. Do not allow any cleaning agent to enter the interior of the product during cleaning. The interior of the product is not designed or permitted to be cleaned.

The interior of the product must be cleaned if incorrect or contaminated lubricant is accidentally filled into the product.

Contact the SKF Service department if this occurs.

#### NOTE

Dismantling of the product or individual parts thereof within the statutory warranty period is prohibited and voids any claims.

#### NOTE

Only original SKF spare parts may be used. Unauthorized alterations to products and the use of non-original spare parts and accessories are prohibited and nullify the statutory warranty.

SKF shall not be held liable for damages resulting from improperly performed assembly, maintenance, or repair work on the product.

## 8.2 Filling the aerosol generator

### 8.2.1 Depressurizing the lubricant reservoir

☞ See Figure 9

#### NOTE

##### Environmental pollution

Lubricants can contaminate soil and waterways. Lubricants must be used and disposed of properly. Observe the applicable regulations and laws regarding the disposal of lubricants.

To depressurize the MQL system, first disconnect it from the customer's compressed air supply. Then relieve the pressure in the MQL aerosol generator (1).

- Switch off the customer's compressed air supply.

☞ Once the compressed air supply is turned off, depressurize the aerosol generator (1). Depending on the optional design of the MQL system, this is done as follows:

- Disconnect the compressed air line from the system and push the coupling (2) downwards.

or:

- Move the slider (3) on the main compressed air valve downwards.

or:

- Open electric main valves (4) via the customer's machine control unit.

Then:

- Briefly actuate the pressure relief valve (6) using the key ring (5).
- Use a pressure gauge (7) to check whether the pressure has been completely released; if necessary, briefly actuate the pressure relief valve (6) again.

### 8.2.2 Filling the aerosol generator

See Figure 9

#### NOTE

Only fill using clean lubricant and an appropriate device. SKF recommends the use of a filling funnel with integrated fine strainer insert.



- Remove closure screw (7) and corresponding gasket

#### VarioPlus:

- Loosen hexagon head screw (AF 27) and check valve from the reservoir lid

Remove closure screw (7) and corresponding gasket

- Hand-tighten closure screw (7)
- Clean aerosol generator (1) from any oil residues
- Switch on compressed air supply provided by the customer

	<b>WARNING</b>
	<p><b>System pressure</b> If the system is already connected to the compressed air supply, you must depressurize the reservoir before filling (see Chapter 8.2.1).</p>

#### NOTE

No aerosol can be generated if the reservoir is overfilled (fill level above the "Maximum" mark on the sight glass). Excess lubricant must therefore be drained in such cases. This is done by opening the oil drain plug, item 8.

- Clean any contaminants from the outside of the Vario or VarioPlus.

#### VARIO



- Loosen closure plug (7) (hexagonal socket head, AF 10) from the reservoir lid

Use a funnel to fill in lubricant up to the sight glass "Maximum"

- Position closure screw (7) and gasket on the aerosol generator (1) observing the correct position of the gasket.

### 8.3 Draining lubricant from the aerosol generator

☞ See Figure 9

	<b>WARNING</b>
	<p><b>System pressure</b> Depressurize the lubricant reservoir before draining the lubricant (see Chapter 8.2.2).</p>

To depressurize the MQL system, first disconnect it from the customer's compressed air supply. Then relieve the pressure in the MQL aerosol generator (1).

- Switch off the customer's compressed air supply.

☞ Once the compressed air supply is turned off, depressurize the aerosol generator (1). Depending on the optional design of the MQL system, this is done as follows:

- Disconnect the compressed air line from the system and push the coupling (2) downwards.
- or:**
- Move the slider (3) on the main compressed air valve downwards.
- or:**
- Open electric main valves (4) via the customer's machine control unit.
- Then:**
- Briefly actuate the pressure relief valve (6) using the key ring (5).
- Use a pressure gauge (7) to check whether the pressure has been completely released; if necessary, briefly actuate the pressure relief valve (6) again.
- Clean any contaminants from the outside of the Vario or VarioPlus.
- Place the oil drip tray (provided by customer) under the Vario or VarioPlus MQL system.
- Carefully loosen the oil drain plug (WAF 10) (8).
  - Remove the oil drain plug (8) with washer (9).
- ☞ After the lubricant has been drained, apply a new washer to the oil drain plug (UFZ.0078).
- Place the oil drain plug (8) with a new washer (9) on the oil drain bore and tighten it.
  - Remove the customer's oil drip tray and clean any oil residues from the outside of the Vario or VarioPlus.



Maintenance work, Fig. 9

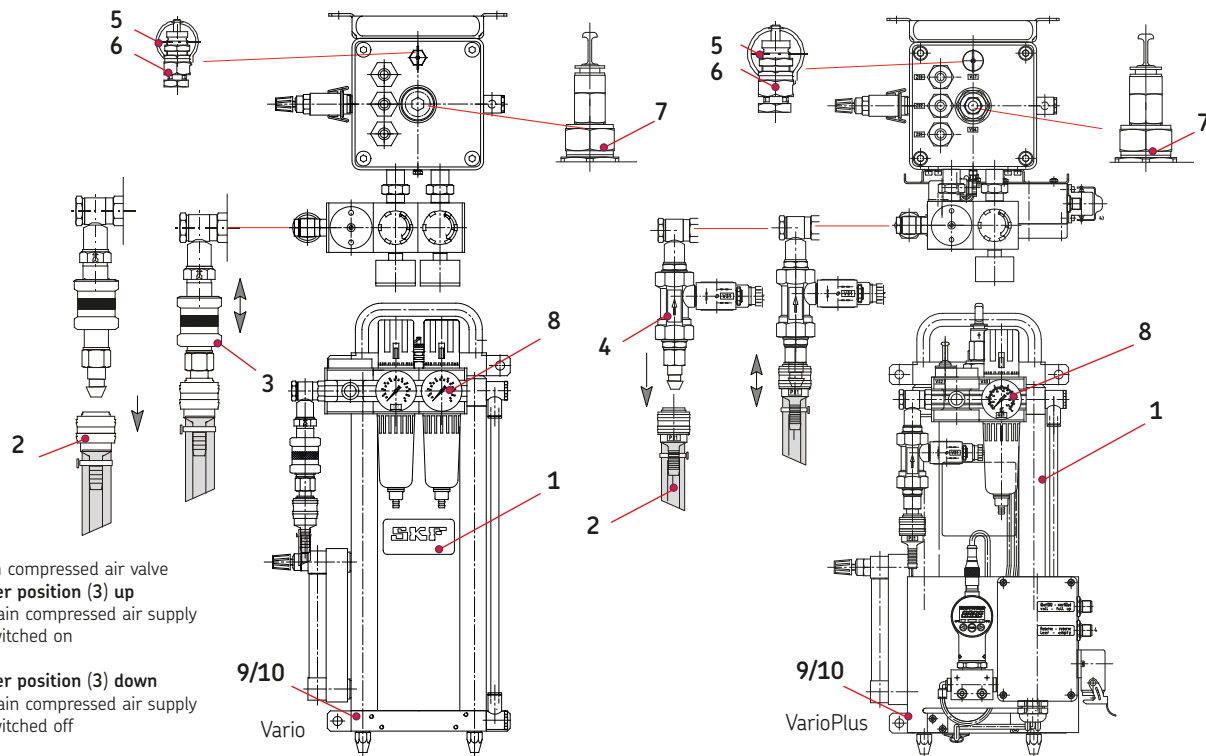



## 9. Malfunctions, causes, and remedies

The following requirements must be met so that the MQL system functions smoothly:

- The system is correctly connected.
- Compressed air with an adequate primary air pressure (at least 6 bar) is supplied.



The following tables provide an overview of possible malfunctions and their causes. Contact the SKF Service department if you cannot remedy the malfunction.

	 <b>WARNING</b>
	<p><b>System pressure</b> The product described here is pressurized during operation. Depressurize the product before starting any assembly, maintenance, or repair work (see Chapter 8.2.1).</p>

<b>NOTE</b>
Dismantling of the product or individual parts thereof within the statutory warranty period is prohibited and voids any claims.

<b>NOTE</b>
All assembly, maintenance, and repair work beyond this scope must be performed by SKF's service department.

<b>NOTE</b>
Only original SKF spare parts may be used. Unauthorized alterations to products and the use of non-original spare parts and accessories are prohibited.

	 <b>WARNING</b>
	<p><b>Electric shock</b> Performing work on products that have not been de-energized may result in serious injury or death. Assembly, maintenance, and repair work may only be performed on products that have been de-energized by qualified technical personnel. The supply voltage must be switched off before opening any of the product's components.</p>

## 9.1 Commissioning, product, and system malfunctions

Malfunction	Cause	Remedy
The system does not produce any aerosol.	<ul style="list-style-type: none"> <li>o Use of lubricants not approved by SKF</li> <li>o The system is defective or misadjusted.</li> </ul>	<ul style="list-style-type: none"> <li>• Use only lubricants which have been approved by SKF.</li> <li>• Contact SKF's service department.</li> </ul>
No aerosol is reaching the tool.	o The aerosol lines are bent, blocked, or have excessive changes in cross-sections.	<ul style="list-style-type: none"> <li>• See the line arrangement instructions in the assembly instructions, Chapter 4,4 page 27 "Connecting aerosol lines."</li> </ul>
	o A shut-off valve (if present) on the spindle inlet is not actuated / is incorrectly actuated.	<ul style="list-style-type: none"> <li>• Contact the manufacturer of the machine tool.</li> </ul>
	o A check valve is installed in the spindle.	<ul style="list-style-type: none"> <li>• Remove the check valve.</li> <li>• See the instructions in the assembly instructions, Chapter 4.4, page 29, "Rotary leadthrough and spindle."</li> </ul>
	o The existing spindle is unsuitable (e.g., rough transitions, excessively narrow cross-section).	<ul style="list-style-type: none"> <li>• Use suitable spindles; contact the manufacturer of the machine tool.</li> </ul>
	o The rotary leadthrough is unsuitable.	<ul style="list-style-type: none"> <li>• See the instructions in the assembly instructions, Chapter 4.4, page 29, "Rotary leadthrough and spindle."</li> </ul>
No aerosol is reaching the tool.	o The transitions from the spindle to the toolholder are unfavorable.	<ul style="list-style-type: none"> <li>• Use only toolholders which are suitable for minimal quantity lubrication.</li> </ul>

Malfunction	Cause	Remedy
No aerosol is reaching the tool.	o The toolholder is leaky.	<ul style="list-style-type: none"> <li>• Use only toolholders which are suitable for minimal quantity lubrication.</li> </ul>
	o The tool has an unsuitable lead-in and a very small cooling duct.	<ul style="list-style-type: none"> <li>• Use only tools which are suitable for minimal quantity lubrication.</li> </ul>
	o For small tools: the primary pressure is too low.	<ul style="list-style-type: none"> <li>• Increase the primary pressure.</li> </ul>
Machining is incorrect despite adequate aerosol discharge at the tool.	o The tool has an unsuitable outlet bore.	<ul style="list-style-type: none"> <li>• Use only tools which are suitable for minimal quantity lubrication.</li> </ul>
	o The cutting parameters are not adapted to machining using minimal quantity lubrication.	<ul style="list-style-type: none"> <li>• Change the production parameters.</li> </ul>

## Electronic pressure switch display

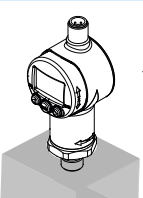
	Display	Cause	Remedy
	E.01	The settings for the switching points and hystereses established a release point outside the permissible setting range. Example: switching point is set to 180 bar and hysteresis to 200 bar.	Correct the settings.
	E.10	A data error was detected in the stored settings. Possible causes are strong electromagnetic interference or a component defect.	Check all settings (programming releases, switching points, release points, and basic settings) and correct them if necessary. If the error occurs frequently, please contact our service department.
	E12	An error was detected in the stored calibration data. Possible causes are strong electromagnetic interference or a component defect.	Disconnect the device from the power supply and then reconnect. If the error message continues to be displayed, the device must be returned to the factory for recalibration or repair.
	E21	Internal communication error	The error can be acknowledged by pressing the "mode" key. If the error message continues to be displayed after acknowledgement, the device must be sent back to the factory.

## 10. Technical data

### 10.1 Vario

#### Characteristics

Designation	Unit	
Housing	AL	
Ambient temperature	°C (°F)	+10 to +40 (50 °F to + 104 °F)
Mounting position		Vertical, connections upward
External dimensions mm		See assembly instructions, Chapter 4.3.1
Weight with full aerosol generator	kg	11
Operating pressure of compressed air		
Primary pressure maximum	bar	10
Primary pressure minimum	bar	6 (8 bar for tools with small aerosol duct)
Aerosol generator capacity	l	1.8
Lubricant output <sup>1)</sup>	ml/h	1-200
Air consumption <sup>1)</sup>	NI/min	1-300
Purity of permissible compressed air		At least quality class 5 as defined by DIN ISO 8573-1: max. particle size/density 40 µm/10 mg/ m <sup>3</sup> ; Pressure dew point 7°C (44,6°F); water content max. 7,800 mg/ m <sup>3</sup> ; residual oil content max. 25 mg/m <sup>3</sup> .
Protection class acc. to EN 60529		IP 54
Specifications for aerosol hoses		Material Polyamide
Compressed air connection of aerosol outlets	∅ mm	12 Coupling socket nom. size 8
<b>Electrical (optional equipment)</b>		
Fill level control		
Rated voltage	VDC	24
Switching current	A	0,25
Switching power	VA	3
Protection class acc. to DIN 40050	IP	64
Main air valve		
Rated voltage	VDC	24
Rated performance	W	8
Duration factor	100% ED	

1) Depends on the diameter of the tool's cooling ducts (back pressure) and the lubricant.

## 10.2 VarioPlus

## Characteristics

Designation	Unit	
Housing		AL
Ambient temperature	°C (°F)	+10 to +40 (50 °F to + 104 °F)
Mounting position		Vertical, connections upward
External dimensions mm		See assembly instructions, Chapter 4.3.1
Weight with full aerosol generator	kg	11.5
Operating pressure of compressed air		
Primary pressure maximum	bar	10
Primary pressure minimum	bar	6 (8 bar for tools with small aerosol duct)
Aerosol generator capacity	l	1.8
Lubricant output <sup>1)</sup>	ml/h	1 - 200
Air consumption <sup>1)</sup>	NI/min	1 - 300
Purity of permissible compressed air		At least quality class 5 as defined by DIN ISO 8573-1: max. particle size/density 40 µm/10 mg/m <sup>3</sup> ; Pressure dew point (44,6°F); water content max. 7,800 mg/ m <sup>3</sup> ; residual oil content max. 25 mg/m <sup>3</sup> .
Protection class acc. to EN 60529		IP 54
Specifications for aerosol hoses		Material Polyamide
Compressed air connection of aerosol outlets	Ø mm	12 Coupling socket nom. size 8
<b>Electrical (optional equipment)</b>		
Fill level control		
Rated voltage	VDC	24
Switching current	A	0,25
Switching power	VA	3
Protection class acc. to DIN 40050	IP	64
Main air valve		
Rated voltage	VDC	24
Rated performance	W	8
Duration factor	100% ED	

1) Depends on the diameter of the tool's cooling ducts (back pressure) and the lubricant.

### 10.2.1 VarioPlus electronic pressure switch

#### Electronic pressure switch, characteristics

##### Input variables

Measuring ranges	10 bar
Overload ranges	30 bar
Burst pressure	50 bar

##### Output variables

Accuracy (display)	$\leq \pm 0.5\%$ FS typ. <sup>1)</sup> $\leq \pm 1\%$ FS max. <sup>1)</sup>
Reproducibility	$\leq \pm 0.25\%$ FS max.
Temperature drift	$\leq \pm 0.25\%$ / 10 K zero point max. $\leq \pm 0.25\%$ / 10 K range max.

##### Switching outputs

Design	PNP transistor output
Switched current	Max. 1.2 A
Switching cycles	> 100 million
Response time	< 10 ms

##### DESINA diagnostic signal (pin 2)

Function	OK: HIGH level; not OK: LOW level
Level	HIGH: = +U <sub>b</sub> ; LOW: < + 0.3 V

##### Ambient conditions

Medium temperature range	-25 to +80°C (-13 °F to + 176 °F)
Ambient temperature range	-25 to +80°C (-13 °F to + 176 °F)

1) FS (Full Scale) = relative to the full measuring range



## Electronic pressure switch, characteristics

Vibration resistance	Approx. 10 g / 0 to 500 Hz
Impact resistance	Approx. 50 g / 11ms
<b>Other data</b>	
Supply voltage	9 to 35 VDC
Power consumption	Max. 35 mA (inactive switching output)
Hydraulic connection	G1/4 A DIN 3852; Form E
Tightening torque	17 to 20 Nm
Wetted parts, thin film DMS	Stainless steel, FKM (FPM) seal
Display:	4-digit, LED, 7-section, red,
Weight:	Approx. 120 g

## 11. Spare parts

Vario spare parts, Fig. 10

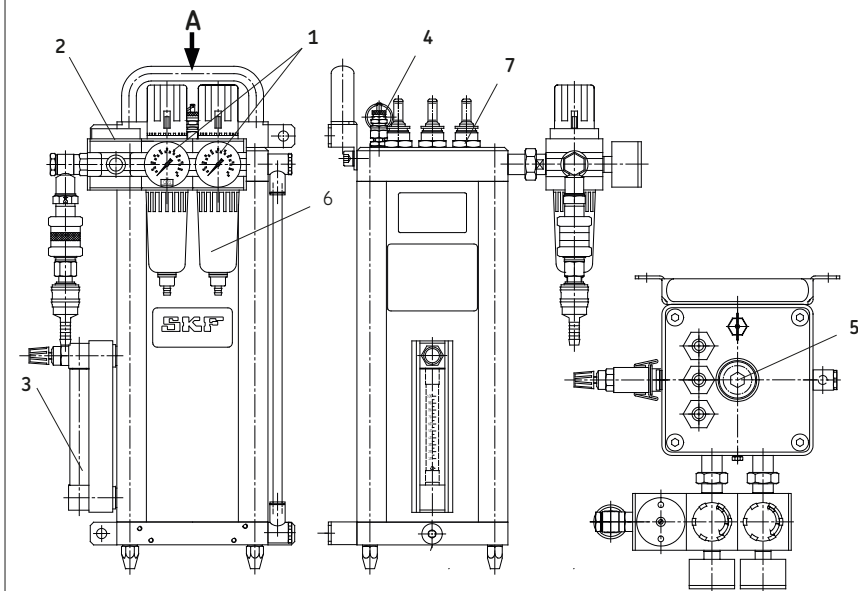

Legend to Figure 10

Item	Description	Order No.
1	Pressure gauge	UFZ.0360
2	Air supply unit, complete	UFV.U16-000
3	Flow meter	UFZ.0127
4	Pressure relief valve	UFZ.U00-132
5	Blanking plug	UFZ.0088
6	Condensate reservoir, cpl.	UFZ.U00-141
7	Screw union for plug connector pipe $\varnothing 12$ , connection G1/2	UFZ.0081

VarioPlus spare parts, Fig. 11

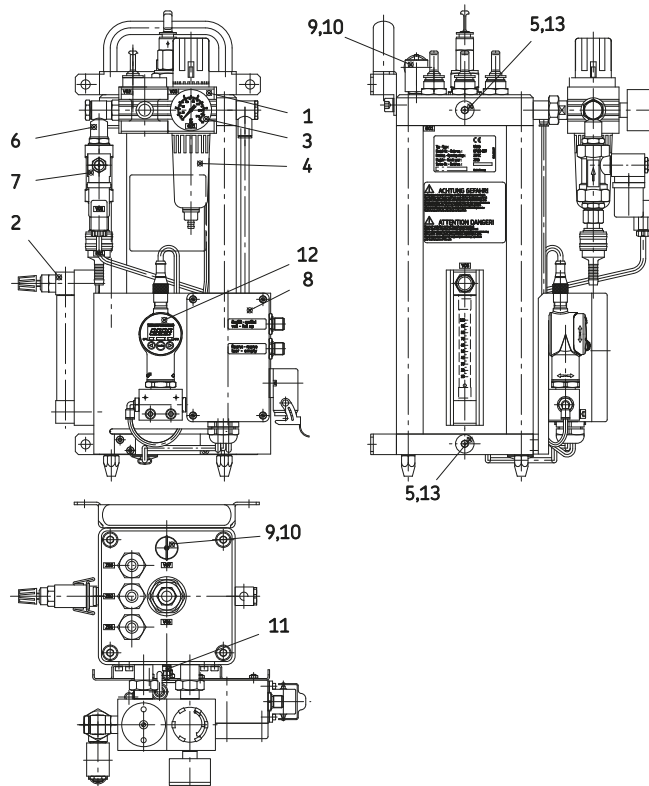

Legend to Figure 11

Item	Description	Order No.
1	Air supply unit, complete	UFV.U16-001
2	Flow meter	UFZ.0127
3	Pressure gauge	UFZ.0360
4	Condensate reservoir	UFZ.U00-141
5	Washer	UFZ.0078
6	Air supply adapter	UFZ.0078
7	Air valve 24 V DC	UFZ.U00-075
8	Terminal box	173-000-222
9	Sleeve	UFZ.0357
10	Pressure relief valve	UFZ.0270
11	Banjo fitting	UFZ.0062
12	Pressure switch, 16 bar	176-190-002
13	Screw plug	466-419-001

Electronic pressure switch, Fig. 12

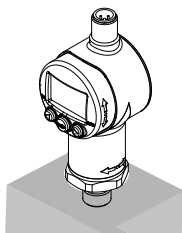

Electronic pressure switch

Electronic pressure switch	Order No.
16 bar	176-190-002
16 bar, with block, cpl.	UFV.U20-000

## 12. Accessories

Ball valve, Fig.13

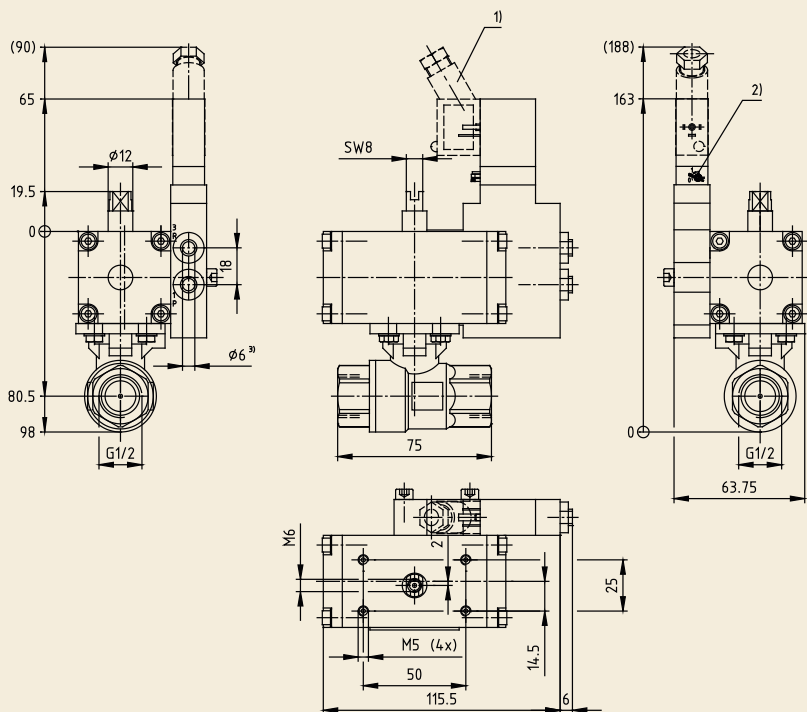

Electrically and pneumatically actuated 2/2  
way ball valve

**Designation**  
Ball valve

**Order No.**  
UFZ.U00-128

- 1) Port for connector socket  
DIN EN 175301-803 type C
- 2) Manual actuation
- 3) Plug connector for pipe 6mm

11

12

3/2 way ball valve, Fig.14

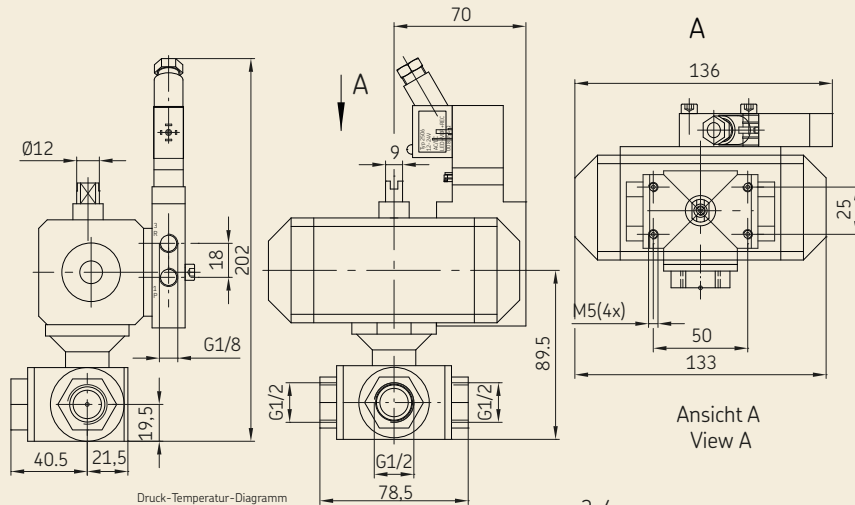

Druck-Temperatur-Diagramm  
Pressure-temperature-diagram

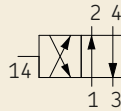
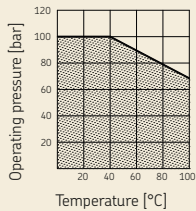

technical data  
4/2-way-solenoid-valve:

3/2 way ball valve

**Designation**  
3/2 way ball valve

**Order No.**  
UFZ.000-041

## Screw unions / aerosol hose / elect. power lead

**Designation**

Plug connector G 1/2, for connecting the aerosol hose to the ball valve

Aerosol hose, specify length when ordering

Power lead for VarioPlus (for Harting connector), 5 m

**Order No.**

UFZ.0081

UFZ.0027

997-000-913

## Cable sockets, Fig. 15

Designation	Order No.	Weight [g]	
<b>Cable sockets M12x1, 4-pin design without LED</b>			
<b>A</b>	<b>Circular connector, straight</b> , without cable diameter 4–6 mm, 4-pin, max. 0.75 mm <sup>2</sup>	<b>179-990-371</b>	15
<b>B</b>	<b>Circular connector, straight</b> , with 5-m integrally extruded cable, 4-pin, 4×0.25 mm <sup>2</sup>	<b>179-990-600</b>	178
<b>B</b>	<b>Circular connector, straight</b> , with 10-m integrally extruded cable, 4-pin, 4×0.25 mm <sup>2</sup>	<b>179-990-603</b>	325
<b>C</b>	<b>Circular connector, angled</b> , without cable diameter 4–6 mm, 4-pin, max. 0.75 mm <sup>2</sup>	<b>179-990-372</b>	16
<b>D</b>	<b>Circular connector, angled</b> , with 5-m integrally extruded cable, 4-pin, 4×0.25 mm <sup>2</sup>	<b>179-990-601</b>	182



For other cable sockets, please refer to brochure No. 1-1730-EN, "Electrical Plug-In Connections."

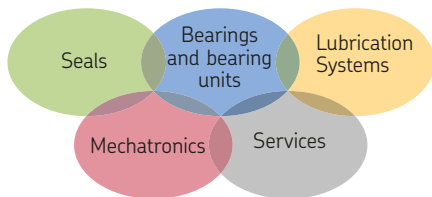

## The Power of Knowledge Engineering

Over the course of more than a century, SKF has specialized in five fields of competence and acquired a wide range of application expertise. We utilize this experience to provide innovative solutions to OEMs and other manufacturers in practically all industrial sectors worldwide. Our five fields of competence are: bearings and bearing units, seals, mechatronics (combining mechanical and electronic components to improve the performance of classic systems), and extensive services from 3-D computer stimulations and modern condition monitoring systems for high reliability to system management. SKF is a leading global company and guarantees its customers uniform quality standards and global product availability.



### Important information on product usage

All products from SKF may be used only for their intended purpose as described in this brochure and the operating instructions. Should operating instructions be supplied together with the products, they must be read and followed.

Not all lubricants can be fed using centralized lubrication systems. SKF can, on request, inspect the suitability of the lubricant selected by the user for pumping in centralized lubrication systems. Lubrication systems and their components manufactured by SKF are not approved for use in conjunction with gases, liquefied gases, pressurized gases in solution, vapors, or such fluids whose vapor pressure exceeds normal atmospheric pressure (1 013 mbar) by more than 0.5 bar at their maximum permissible temperature.

Particular attention is called to the fact that hazardous materials of any kind, especially the materials classified as hazardous by EC Directive 67/548/EEC, Article 2, Para. 2, may only be filled into SKF centralized lubrication systems and components and delivered and/or distributed with such systems and components after consulting with and obtaining written approval from SKF.

951-170-221-EN

January 2016

#### SKF Lubrication Systems Germany GmbH

Motzener Strasse 35/37 · 12277 Berlin · Germany

PO Box 970444 · 12704 Berlin · Germany

Tel. +49 (0)30 72002-0

Fax +49 (0)30 72002-111

[www.skf.com/lubrication](http://www.skf.com/lubrication)

#### SKF Lubrication Systems Germany GmbH

2. Industriestrasse 4 · 68766 Hockenheim · Germany

Tel. +49 (0)62 05 27-0

Fax +49 (0)62 05 27-101

[www.skf.com/lubrication](http://www.skf.com/lubrication)

