

KFG; KFGS; KFGL; KFGC (CAN bus) for vehicle lubrication

Assembly instructions acc. to EC Dir. 2006/42/EC
for partly completed machinery with associated operating instructions

EN

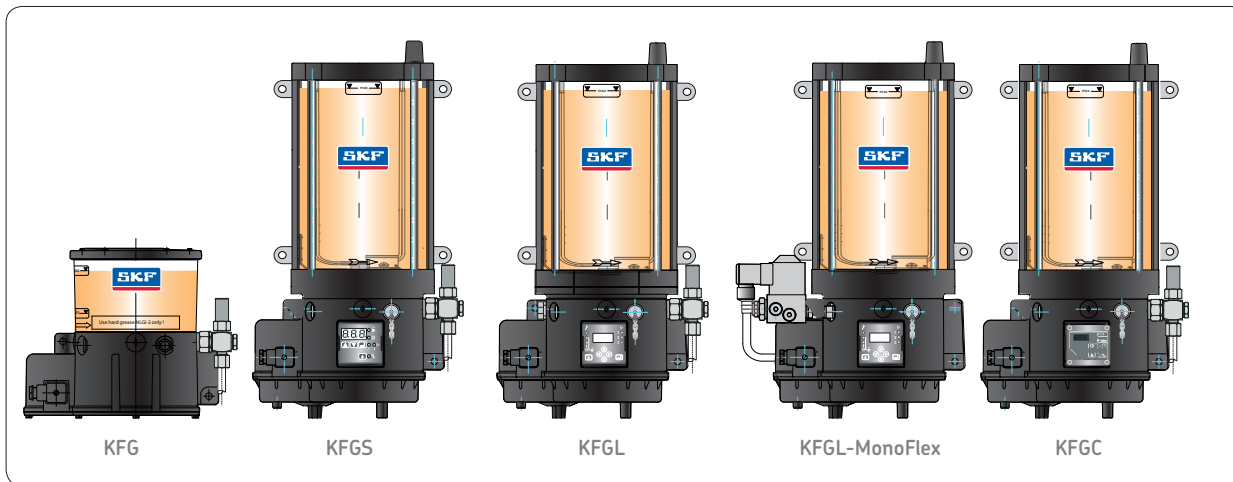

Masthead

These assembly instructions with associated operating instructions according to EC Machinery Directive 2006/42/EC are an integral part of the described product and must be kept for future use.

These assembly instructions with associated operating instructions have been prepared in accordance with the established standards and rules for technical documentation, VDI 4500 and EN 292.

© SKF Lubrication Systems Germany AG

This documentation is protected by copyright. SKF Lubrication Systems Germany AG reserves all rights, including those to the photomechanical reproduction, duplication, and distribution by means of special procedures (e.g., data processing, data media, and data networks) of this documentation in whole or in part.

Subject to changes in contents and technical information.

Service

If you have technical questions, please contact the following addresses:

SKF Lubrication Systems Germany AG

Berlin Plant

Motzener Straße 35/37
12277 Berlin, Germany
Germany
Tel. +49 (0)30 72002-0
Fax +49 (0) 30 72002 111

Hockenheim Plant

2. Industriestrasse 4
68766 Hockenheim
Germany
Tel. +49 (0)62 05 27-0
Fax +49 (0) 62 05 / 27-101

lubrication-germany@skf.com
www.skf.com/lubrication

Assembly instructions table of contents

Information concerning EC Declaration of Conformity and EC Declaration of Incorporation	6	4.2.2 Mounting diagram	18	4.7.3 Connectivity Counter operation with system monitoring	32
Explanation of symbols and signs	7	4.2.3 Mounting dimensions, without control unit	19	4.7.4 Connectivity Timer operation without system monitoring	33
Documentation overview	8	4.2.4 Mounting dimensions, with control unit	20	4.7.5 Connectivity Timer operation with system monitoring	33
1. Safety instructions	8	4.3 Pump elements	21	4.8 KFGL power supply and connections	34
1.1 Intended use	9	4.3.1 Pump element designs	21	4.8.1 KFGL power supply	34
1.2 Authorized personnel	9	4.3.2 Pump elements with spring-return pistons	22	4.8.2 KFGL ProFlex for progressive centralized lubrication systems	35
1.3 Electric shock hazard	10	4.3.3 Assembly of a pump element with spring return pistons	23	4.8.3 KFGL MonoFlex for single-line lubrication systems	36
1.4 System pressure hazard	10	4.3.4 Pump elements with positively driven pistons	24	4.9 KFGC power supply and connections	37
1.5 Compressed air hazard	10	4.3.3 Assembly of a pump element with positively driven pistons	25	4.9.1 Power supply	37
1.6 Hydraulic pressure hazard	10	4.3.4 Pressure regulating valve	26	4.9.2 Connectivity	39
1.7 Explosion protection information	11	4.4 Information on lubricant filling	27	4.10 Pressure relief valve with integrated pressure regulating valve	41
2. Lubricants	12	4.4.1 Lubricant filling	27	4.11 Fill level monitoring	42
2.1 General information	12	4.4.2 Filler coupling	28	4.11.1 Order code 1 (W1)	42
2.2 Selection of lubricants	12	4.4.3 Filling cylinder	28	4.11.2 Order code 2 (W1G)	43
2.3 Approved lubricants	13	4.5 Electrical power supply	29	4.11.3 KFG connection with fill level monitoring, order code 1 and 2	44
2.4 Lubricants and the environment	14	4.5.1 General conditions for electrical connections	29	4.11.4 Pump unit fill level control	45
2.5 Lubricant hazards	14	4.6 KFG power supply and connections	30	4.12 Lubrication line connection	45
3. Overview	15	4.6.1 KFG power supply	30	4.13 Lubrication line arrangement	45
4. Assembly	16	4.6.2 External control units	30	4.14 Progressive system ventilation	46
4.1 General information	16	4.7 KFGS power supply and connections	31	4.15 Single-line system ventilation	46
4.2 Setup and attachment	16	4.7.1 KFGS power supply	31	4.16 Note on the rating plate	46
4.2.1 Minimum clearance height for installation	17	4.7.2 Connectivity Counter operation without system monitoring	32		

Operating instructions table of contents

1. Safety instructions	50	6. Functional description in progressive systems	56	8. Commissioning	65
1.1 General information	50	6.1 Functional description for progressive systems with a KFG pump unit	56	8.1 General commissioning	65
1.2 Disclaimer of liability	50	6.1.1 Pump element	56		
2. Lubricants	50	6.1.2 Pressure regulating valve	57		
		6.2 Progressive system with a KFGS or KFG L pump unit	58	9. KFGS control unit	66
3. Transport, delivery, and storage	51	6.3 Progressive systems with KFGC (CAN bus) pump unit	59	9.1 Display and control elements of control screen	66
3.1 Lubrication units	51			9.1.1 Three-digit LED display	67
3.2 Electronic and electrical devices	51			9.1.2 LED display	69
3.3 General notes	51			9.1.3 Pushbutton operation	70
		7. Functional description in single-line systems	60	9.2 KFGS display mode	71
4. Assembly	52	7.1 KFG-Pump unit	60	9.3 KFGS programming	73
4.1 Information on assembly	52	7.1.1 Pump element	60	9.3.1 Start programming mode	73
4.2 Pump unit assembly procedure	52	7.1.2 Pressure relief valve	60	9.3.2 Change lubrication interval times	73
		7.1.3 Pressure regulating valve	60	9.3.3 Configure system monitoring	75
5. Design and function	52	7.2 Functional description: (single-line systems) with KFG L-Pump unit	62	9.3.4 Change operating modes	76
5.1 General information	52	7.3 Functional description in single-line systems with a KFGC (CAN-Bus) pump unit	64	9.3.5 Change access code	77
5.2 Design	52	7.3.1 Systems with 3/2 directional solenoid valves	64	9.3.6 Programming ranges	78
5.2.1 Pump housing	52	7.3.2 Multiple lubrication zones	64	9.3.7 Display ranges	78
5.2.2 Lubricant reservoir	53			9.4 KFGS operating modes	78
5.2.3 Fill level monitoring	53			9.4.1 Timer operation	78
5.2.4 KFGS and KFG L control units	53			9.4.2 Counter operation	78
5.3 KFG pump units	53			9.4.3 No system monitoring	79
5.4 KFGS pump units	54			9.4.4 With system monitoring	79
5.5 KFG L pump units	54			9.5 Fill level monitoring	79
5.6 KFGC pump units	55			9.5.1 Monitoring via piston detector	79

10. KFGL control unit	81	14. Operational and pump faults	95	15. Technical data	102
10.1 Display and control elements of control screen	81	14.1 Operational malfunctions	95		
10.2 Display and control menu	83	14.1.1 General information	95		
10.2.1 Main menu	83	14.1.2 Malfunctions on pump units	95	16. Accessories	105
10.2.2 Info - Information mode	84	14.2 Malfunctions on KFGS pump units	97		
10.2.3 Config. - Configuration mode	86	14.2.1 Display faults	97		
10.3 Programming a KFGL pump unit	88	14.2.2 Delete fault notification	97		
		14.2.3 Fault types	98		
		14.2.4 Recording fault times	99		
		14.2.5 Malfunctions on KFGS pump unit with a progressive feeder system	99		
11. KFGC control unit	89	14.3 Malfunctions on KFGL pump unit	100		
11.1 KFGC series (CAN bus)	89	14.3.1 Display faults	100		
		14.3.2 Delete fault notification	100		
12. Shutdown/disposing	91	14.3.3 Fault types	100		
12.1 Temporary shutdown	91	14.3.4 Fault notifications	100		
12.2 Permanent shutdown	91	14.4 Malfunctions on KFGC pump unit	101		
		14.4.1 Faults detected by control unit	101		
13. Maintenance and service	92	14.4.2 Fault types	101		
13.1 General information	93	14.4.3 Read faults	101		
13.2 Maintenance and repair	93	14.4.4 Remedy faults	101		
13.3 Service	93				

Information concerning EC Declaration of Conformity and EC Declaration of Incorporation

The product, reservoir unit of the series:
KFG, KFGS, KFGL, KFGC

is hereby confirmed to comply with the essential protection requirements stipulated by the Directive(s) of the Council on the approximation of laws of the Member States concerning:

- **Machinery directive 2006/42/EC**
- **Low voltage devices 2006/95/EC**
- **Electromagnetic compatibility 2004/108/CE**

Notes:

- (a) This declaration certifies compliance with the aforementioned Directives, but does not constitute a guarantee of characteristics.
- (b) The safety instructions in the documentation included with the product must be observed.
- (c) The commissioning of the products here certified is prohibited until such time as the machine or vehicle in which the product is installed conforms with the provisions and requirements of the applicable Directives.

(d) The operation of the products at non-standard supply voltage, as well as non-adherence to the installation instructions, can negatively impact the EMC characteristics and electrical safety.

We further declare:

- The aforementioned product is, **according to EC Machinery Directive 2006/42/EC, Annex II Part B, designed for installation in machinery / for incorporation with other machinery to form a machine.** Within the scope of application of the EC Directive, commissioning shall be prohibited until the machinery in which this part is installed conforms with the provisions of this Directive.
- The aforementioned product may, with reference to EC Directive 97/23/EC concerning pressure equipment, only be used in accordance with its intended use and in conformity with the instructions provided in the documentation..The following must be observed in this regard:

The product is neither designed nor approved for use in conjunction with fluids of Group 1 (Dangerous Fluids) as defined in Article 2, Para. 2 of Directive 67/548/EEC of June 27, 1967. The product is neither designed nor approved for use in conjunction with gases, liquefied gases, pressurized gases in solution, vapors and such fluids whose vapor pressure exceeds normal atmospheric pressure (1013 mbar) by more than 0.5 bar at their maximum permissible temperature.

When used in conformity with their intended use, the products supplied by SKF Lubrication Systems Germany AG do not reach the limit values listed in Article 3, Para. 1, Clauses 1.1 to 1.3 and Para. 2 of Directive 97/23/EC. They are therefore not subject to the requirements of Annex 1 of the Directive. Consequently, they do not bear a CE marking in respect of Directive 97/23/EC. SKF Lubrication Systems Germany AG classifies them according to Article 3, Para. 3 of the Directive. The Declaration of Conformity and Incorporation forms part of the product documentation and is supplied together with the product.

Explanation of symbols and signs

You will find these symbols, which warn of specific dangers to persons, material assets, or the environment, next to all safety instructions in these operating instructions.

Please heed these instructions and proceed with special care in such cases. Please forward all safety instructions to other users.

Instructions placed directly on the machines/ grease lubrication pump units, such as:







- Arrow indicators
 - Labels for fluid connections
- must be followed and kept in fully legible condition.



You are responsible!

Please read the assembly and operating instructions thoroughly and follow the safety instructions.



Hazard symbols

-  General hazard
DIN 4844-2-W000
-  Electrical voltage/current
DIN 4844-2-W008
-  Hot surface
DIN 4844-2-W026
-  Danger of being drawn into machinery
BGV 8A
-  Slipping hazard
DIN 4844-2-W028
-  Warning of potentially explosive atmosphere
DIN 4844-2-W021

Indicators used with safety instructions and their significance

Signal word	Meaning
Danger!	Danger of bodily injury
Warning!	Of damage to property and the environment
Note!	Provides additional information

Informational symbols

-  Note!
 - Prompts an action
 - Used for itemizing
 - ➔ Refers to other facts, causes or consequences
 -  Provides additional information

Documentation overview

Description/ Document number

LC502 control unit for ProFlex
progressive centralized lubrication systems
951-180-005-EN

LC502 control unit for MonoFlex
single-line lubrication systems
951-180-004-EN

KFG; KFGS; KFGC (CAN bus) for
vehicle lubrication
951-170-204-EN

CAN bus control system description
951-130-502-EN

1. Safety instructions



The operator of the described product must ensure that the assembly instructions are read and understood by all persons tasked with the assembly, operation, maintenance, and repair of the product. The assembly instructions must be kept readily available.



Note that the assembly instructions form part of the product and must accompany the product if sold to a new owner.



In addition to the assembly instructions, general statutory regulations and other regulations for accident prevention and environmental protection must be observed and applied.

The described product is manufactured in accordance with the generally accepted rules and standards of industry practice and with occupational safety and accident prevention regulations. Risks may, however, arise from its usage and may result in physical harm to persons or damage to other material assets. Therefore the product may only be used in proper technical condition and in observance of the assembly instructions. In particular, any malfunctions which may affect safety must be remedied immediately.

1.1 Intended use

Pump units of SKF's KFG, KFGS, KFGL and KFGC series are used to supply centralized lubrication systems in vehicles, systems and machines. They deliver oils and greases (up to NLGI Grade 2).

The use of synthetic oils requires prior approval from SKF Lubrication Systems Germany AG.

Any other usage is deemed non-compliant with the intended use.

In particular, the described product is neither designed nor approved for use in conjunction with fluids of Group 1 (Dangerous Fluids) as defined in Article 2, Para. 2 of Directive 67/548/EC of June 27, 1967.

The product described here is neither designed nor approved for use in conjunction with gases, liquefied gases, pressurized gases in solution, vapors and such fluids whose vapor pressure exceeds normal atmospheric pressure (1013 mbar) by more than 0.5 bar at their maximum permissible temperature.

Unless specially indicated otherwise, products from SKF Lubrication Systems Germany AG are not approved for use in potentially explosive areas as defined in the ATEX Directive 94/9/EC.

1.2 Authorized personnel

Only qualified technical personnel may install, operate, maintain, and repair the products described in the assembly instructions. Qualified technical personnel are persons who have been trained, assigned and instructed by the operator of the final product into which the described product is incorporated. Such persons are familiar with the relevant standards, rules, accident prevention regulations, and assembly conditions as a result of their training, experience, and instruction. They are authorized to identify and perform necessary actions while avoiding any risks which may arise.

The definition of qualified personnel and the prohibition against employing non-qualified personnel are laid down in DIN VDE 0105 and IEC 364.

1.3 Electric shock hazard

Electrical connections for the described product may only be established by qualified and trained personnel authorized to do so by the operator, and in observance of the local conditions for connections and local regulations (e.g., DIN, VDE). Significant bodily injury and property damage may result from improperly connected products.



Danger!

Work on products that have not been de-energized may result in bodily injury. Assembly, maintenance and repair work may only be performed on products that have been de-energized by qualified technical personnel. Supply voltage must be switched off before opening any of the product's components.



The protective earth conductor (PE) must always be connected. Always ensure adequate, standard conductor diameter and secure contact.



Dangerous contact voltages may occur on the unit if the protective earth conductor is not connected or is interrupted.

1.4 System pressure hazard



Lubrication systems are pressurized during operation. Centralized lubrication systems must therefore be depressurized before starting assembly, maintenance or repair work, or any system modifications or system repairs.

1.5 Compressed air hazard



The described product is pressurized during operation. The product must therefore be depressurized before starting assembly, maintenance or repair work, or any system modifications or system repairs.

Depending on the model design, the product may be able to be operated with compressed air.

1.6 Hydraulic pressure hazard



The described product is pressurized during operation. The product must therefore be depressurized before starting assembly, maintenance or repair work, or any system modifications or system repairs.

Depending on the model design, the product may be able to be operated hydraulically.

1.7 Explosion protection information



Danger!

Only the pump models tested and approved by SKF Lubrication Systems Germany AG in accordance with ATEX Directive 94/9/EC are permitted to be used in areas with explosion protection. The relevant protection class is engraved on the pump's rating plate.

- When filling lubricant into the pump, make sure the lubricant is clean. The reservoir must be filled in good time (pay attention to fill level monitoring). The pump unit may only be filled via the filler socket.
 - In case of overfilling, the excessive amount of lubricant must be removed. Make sure there is no potentially explosive atmosphere when doing this.
 - The switching circuits of the fill level monitor must be supplied by an intrinsically safe circuit, e.g., through the installation of an ATEX-compliant isolating switch by the customer.
- The unit must be grounded via a ground connection. The customer must install adequate overload protection for the power consumption of the motor.
- To avoid electrostatic discharge, lay hydraulic connecting lines in corrosion-resistant metal tubing, e.g., stainless steel pipe.
 - When setting up the pump, make sure the setup location is level and not subject to vibrations or jolts.
 - During maintenance work, use only tools intended for use in potentially explosive spaces or else make certain that there is no potentially explosive atmosphere present.
 - The service life of the pump units is limited. It must therefore undergo a function and leak test at regular intervals. Perform appropriate repairs in the event of malfunctions, leaks, or rust. Replace the pump if necessary.
 - The user must make sure through the choice of the lubricant to be delivered that no chemical reactions capable of serving as ignition sources will occur in conjunction with the explosive atmospheres expected. The lubricant's ignition temperature has to be at least 50 kelvin above the pump's maximum surface temperature (temperature class).
- Depending on the model design, the product may be available in an explosion-proof design.

2. Lubricants

2.1 General information



All products from SKF Lubrication Systems Germany AG may be used only for their intended purpose and in accordance with the information in the product's assembly instructions.

Intended use is the use of the products for the purpose of providing centralized lubrication/lubrication of bearings and friction points using lubricants within the physical usage limits which can be found in the documentation for the devices, e.g., assembly instructions/operating instructions and the product descriptions, e.g., technical drawings and catalogs. Particular attention is called to the fact that hazardous materials of any kind, especially the materials classified as hazardous by EC Directive 67/548/EEC, Article 2, Para. 2, may only be filled into SKF centralized lubrication systems and components and delivered and/or distributed with the same after consultation with and written approval from SKF Lubrication Systems Germany AG.

No products manufactured by SKF Lubrication Systems Germany AG are approved for use in conjunction with gases, liquefied gases, pressurized gases in solution, vapors, or such fluids whose vapor pressure exceeds normal atmospheric pressure (1013 mbar) by more than 0.5 bar at their maximum permissible temperature.

Other media which are neither lubricant nor hazardous substance may only be fed after consultation with and written approval from SKF Lubrication Systems Germany AG. SKF Lubrication Systems Germany AG considers lubricants to be a component of the system design which must be factored into the selection of components and the design of centralized lubrication systems. The lubricating properties of the lubricants are critically important in these considerations.

2.2 Selection of lubricants



Observe the instructions from the machine manufacturer regarding the lubricants that are to be used.



Warning!

The amount of lubricant required at a lubrication point is specified by the bearing or machine manufacturer. It must be ensured that the required quantity of lubricant is provided to the lubrication point. The lubrication point may otherwise not receive adequate lubrication, which can lead to damage and failure of the bearing.

Selection of a lubricant suitable for the lubrication task is made by the machine/system manufacturer and/or the operator of the machine/system in cooperation with the lubricant supplier.

The bearings/friction points that require lubrication, their expected load during operation, and the expected ambient conditions are taken into account during selection, with consideration of economic and environmental aspects.



SKF Lubrication Systems Germany AG supports customers in the selection of suitable components for feeding the selected lubricant and in the planning and design of a centralized lubrication system.

Please contact SKF Lubrication Systems Germany AG if you have further questions regarding lubricants. Lubricants can be tested in the company's laboratory for their suitability for pumping in centralized lubrication systems (e.g., "bleeding").

You can request an overview of the lubricant tests offered by SKF Lubrication Systems Germany AG from the company's Service department.

2.3 Approved lubricants



Warning!

Only lubricants approved for the product may be used. Unsuitable lubricants can lead to failure of the product and to property damage.



Warning!

Different lubricants cannot be mixed, as mixing may result in damage and necessitate costly and complicated cleaning of the product/lubrication system. It is recommended that an indication of the lubricant in use be attached to the lubricant reservoir in order to prevent accidental mixing of lubricants.

The product described here can be operated using lubricants that meet the specifications in the technical data.

Note that in rare cases, there may be lubricants whose properties are within permissible limit values but whose other characteristics render them unsuitable for use in centralized lubrication systems. For example, synthetic lubricants may be incompatible with elastomers.

2.4 Lubricants and the environment



Warning!

Lubricants can contaminate soil and bodies of water. Lubricants must be properly used and disposed of. Observe the local regulations and laws regarding the disposal of lubricants.

It is important to note that lubricants are environmentally hazardous, flammable substances which require special precautionary measures during transport, storage, and processing. Consult the safety data sheet from the lubricant manufacturer for information regarding transport, storage, processing, and environmental hazards of the lubricant that will be used. The safety data sheet for a lubricant can be requested from the lubricant manufacturer.



Danger!

Centralized lubrication systems must always be free of leaks. Leaking lubricant is hazardous due to the risk of slipping and injury. Be mindful of any lubricant leaking out during assembly, operation, maintenance, and repair of centralized lubrication systems. Leaks must be sealed off without delay.

Lubricant leaking from centralized lubrication systems is a serious hazard. Leaking lubricant can create risks that may result in physical harm to persons or damage to other material assets.



Follow the safety instructions on the lubricant's safety data sheet.

Lubricants are a hazardous substance. The safety instructions on the lubricant's safety data sheet must be followed. The safety data sheet for a lubricant can be requested from the lubricant manufacturer.

3. Overview

		Unit components
Pos.	Description	Chapter
1	Assembly holes	4.2.2-4.2.4
2	Lubricant reservoir	4.2.3-4.2.4
3	Fill level monitoring	4.11-4.11.4
4	Lubricant filling	4.4-4.4.3
5	Pump element	4.3-4.3.3
6	Pressure regulating valve	4.3.4
7	Electrical connection	4.5-4.5.1
8	Control port assignments	4.6-4.9
9	KFGS control unit	OI Chapter 9
10	KFGL control unit	OI Chapter 10
11	KFGC control unit	OI Chapter 11
12	Shutdown	OI Chapter 12
13	Maintenance	OI Chapter 13
14	Operational and pump faults	OI Chapter 14
15	Technical data	OI Chapter 15



OI = Operating instructions

4. Assembly

4.1 General information

Pump units of the KFG series are an integral component of centralized lubrication systems used in machines and systems.

They deliver greases up to NLGI Grade 2. The pump units differ in terms of the size of lubricant reservoir, the lubricant filling and their control and function monitoring. The installation of volume-specific pump elements permits a single unit of the KFG, KFGS or KFGL series to operate up to three independent zones.

The KFGC series is capable of operating up to four independent zones, depending on the task. The system can be equipped with or without functionality to monitor pressure build-up and reduction.

Before assembling/setting up the reservoir unit, the packaging material and any shipping braces (e.g., plugs) must be removed. The packaging material must be preserved until any discrepancies are resolved.

4.2 Setup and attachment

The pump unit should be installed in a place protected from contamination, water splashes and vibrations. It should, however, be easily accessible so that all other installations can be performed without difficulty and the device can be filled easily. The fill level of the reservoir must be easily visible. The unit mounting position is vertical. Any assembly holes must be made according to the diagram on the following page. Design specifications and conditions of the manufacturer and the object must be observed when installing the pump unit.

A drilling jig can be ordered (order number 951-130-115).

During assembly and especially when drilling, always pay attention to the following:

- Existing supply lines must not be damaged by assembly work.
- Other units must not be damaged by assembly work.
- The product must not be installed within range of moving parts.
- The product must be installed at an adequate distance from sources of heat.
- Maintain safety clearances and comply with local regulations for assembly and accident prevention.



Warning!

On the pump units' electrical connections, ensure that appropriate measures prevent interference between signals due to inductive, capacitive or electro-magnetic couplings.

Shielded cables must be used in places where electrical interference fields can distort signal transmissions despite separate laying of cables.

The rules and empirical values for "EMC-compliant" cabling must be taken into consideration.



Warning!

Do not tilt or drop the KFG (S) (L) (C) grease lubrication pump unit!

Install the pump units on the machine using three (2kg/6kg), four (10 kg), or six (15 kg/20 kg) M8 screws with a minimum length of 20 mm.

Fastening material to be provided by the customer:

- Hexagon head screws (3x, 4x or 6x) per DIN933-M8x....-8.8
- Washers (3x, 4x or 6x) per DIN 125-B8.4-St



Warning!

The torque of the fastening screws depends on the customer's installation. Make sure that torque is adequate when installing the pump unit!



Warning!

When drilling the assembly holes, you must be careful of any supply lines or other units, as well as of other hazards such as moving parts.

Maintain safety clearances and comply with local regulations for assembly and accident prevention.

4.2.1 Minimum clearance height for installation

The minimum clearance height for installation depends on the reservoir design.

To ensure enough space for maintenance work and for any disassembly of the pump unit, add at least 20 mm additional clearance onto the total height of the pump (minimum clearance height for installation).

Minimum clearance height for installation

Pump size	without control unit [mm]	with control unit [mm]
2 kg	250	301
6 kg	363	415
10 kg	735	785
15 kg	960	1010
20 kg	1140	1190

-see drawings Fig. 2 and Fig. 3

4.2.2 Mounting diagram

Mounting diagram, Fig. 1

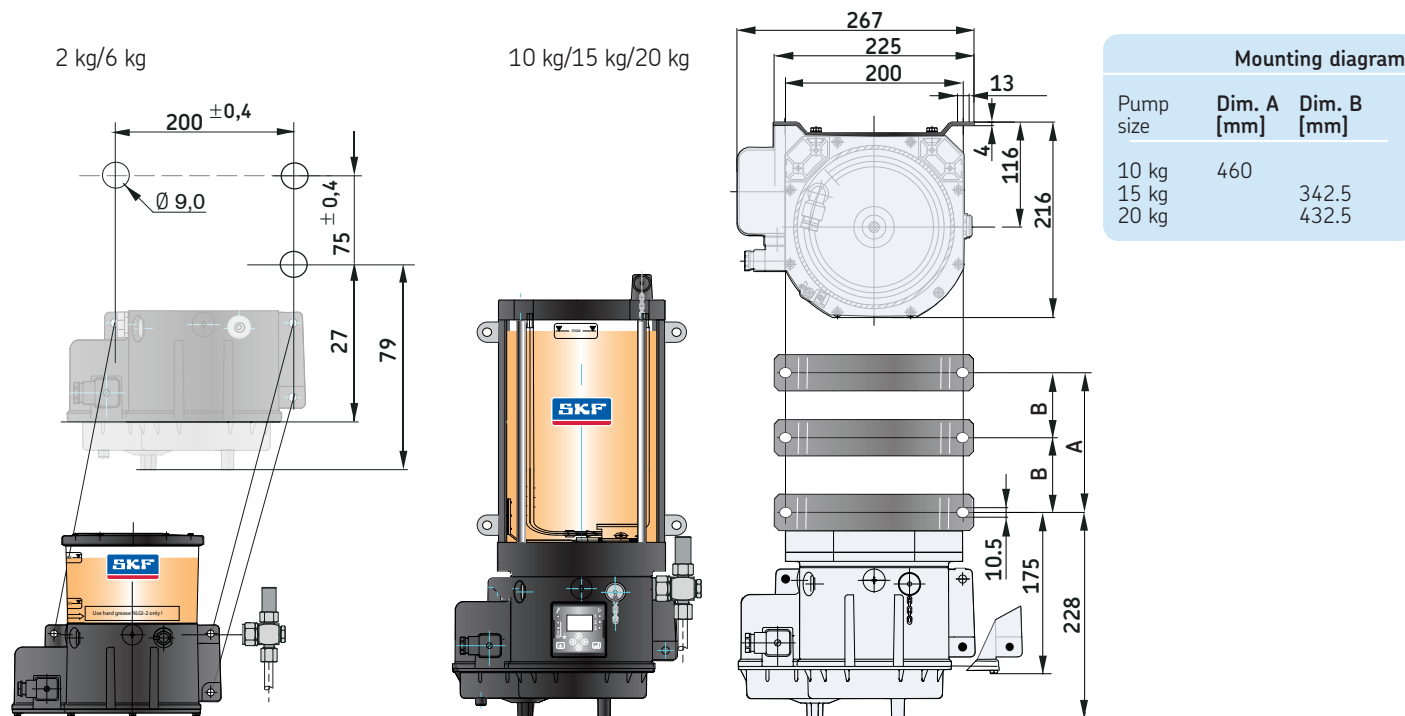

4.2.3 Mounting dimensions, 12 VDC / 24 VDC design without control unit

Assembly dimensions, Fig. 2

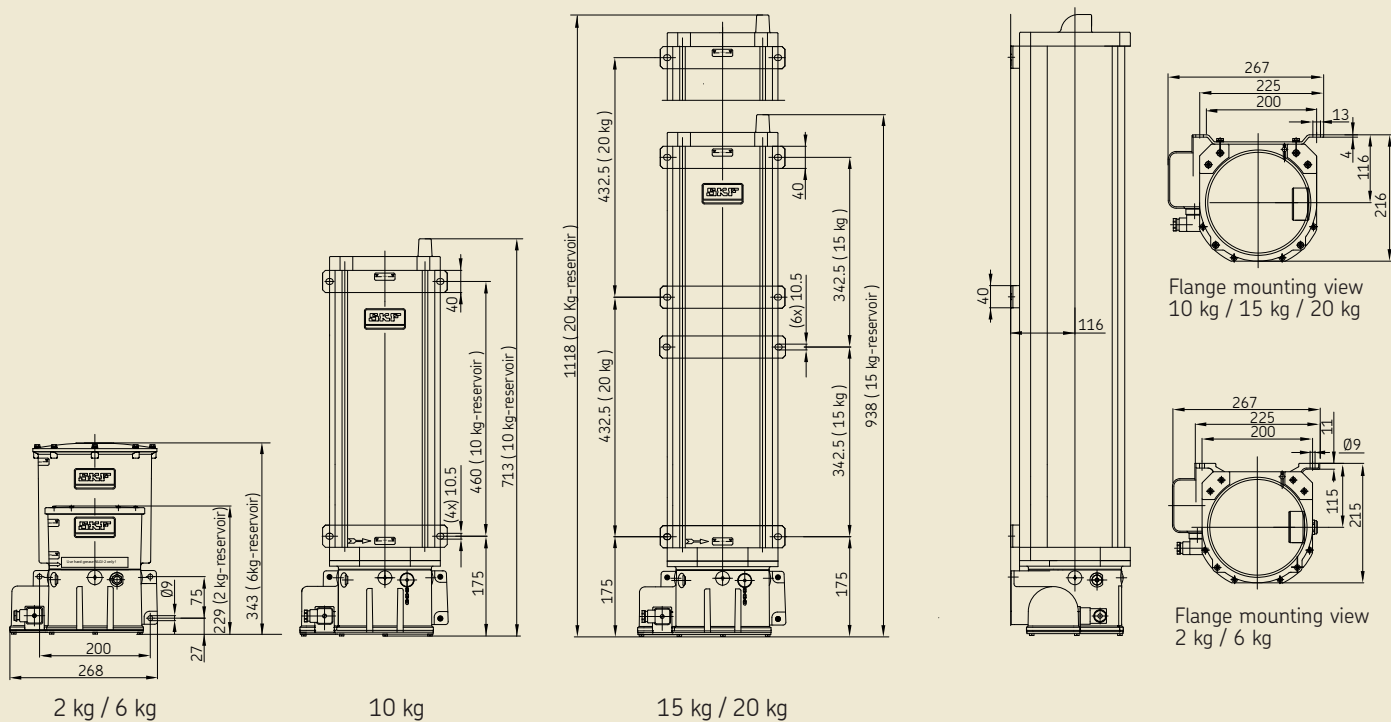

4.2.4 Mounting dimensions, design with control unit, 12 VDC / 24 VDC

Assembly dimensions, Fig. 3

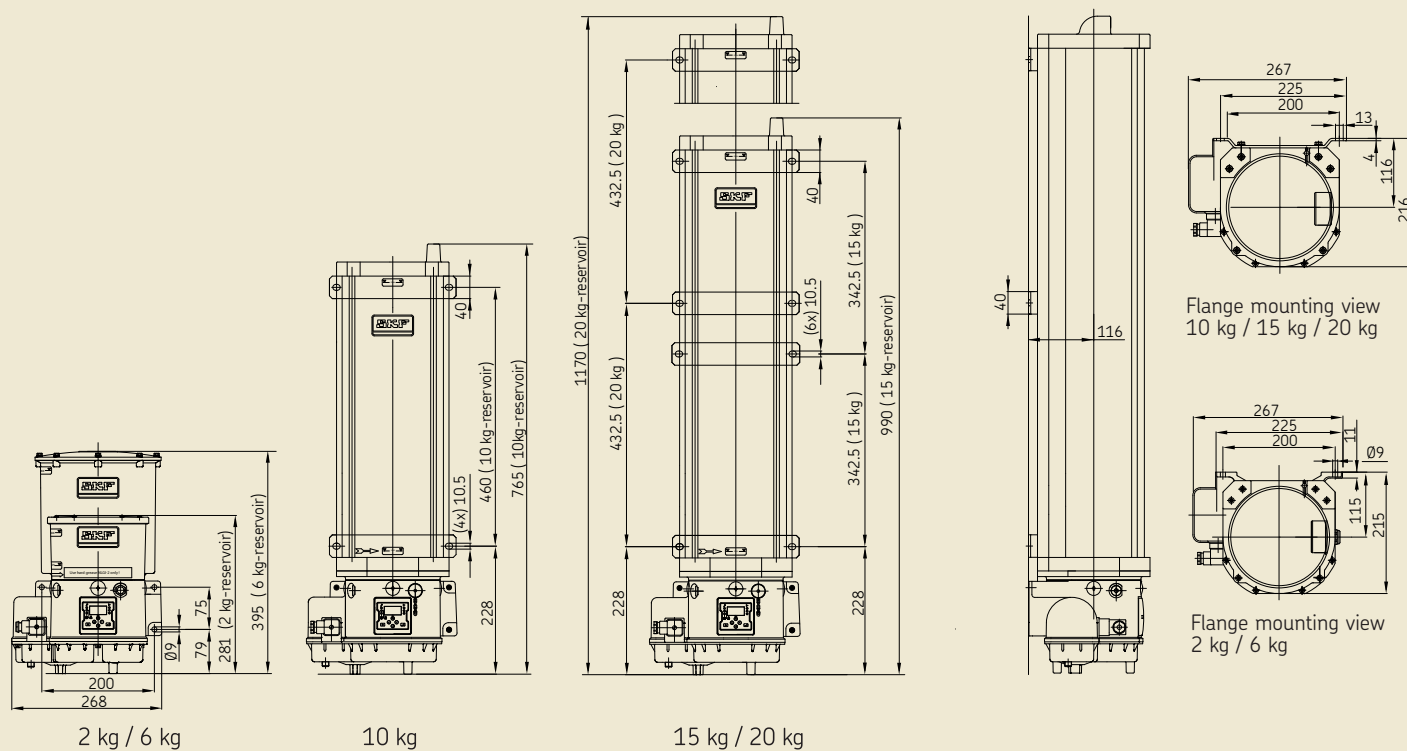

4.3 KFG (S) (L) (C) pump element series

KFG pump units can be equipped with up to three pump elements.

Depending on the pump unit's application (ProFlex/MonoFlex) and configuration (KFG/KFGS/KFGL/KFGC), it is possible to connect each of the pump elements to a single, independent lubrication zone and/or to link them together to form a shared zone.

The pump elements are available in two types of design: with spring return pistons or positively driven pistons.

In both types, the pistons are actuated by a cam disc. In the spring return design, the piston of the pump element is pressed against the cam disc by a spring. In the positively driven design, on the other hand, the piston of the pump element is slotted into the cam disc, which is especially practical when the unit is used at very low temperatures.

The pump elements are available in different models for different delivery rates.

A grease return or a filler socket can be attached in place of a pump element. A screw plug (DIN 910-M20x1.5-5.8) with sealing ring (DIN 7603-A20x24-Al) can also be fitted if desired. Alternatively the screw plug can be ordered from SKF under order number KFG 1.128.

4.3.1 Pump element designs

Pump units of the KFG series are generally delivered with pump elements installed. Perform the following to later add or replace a pump element:

Layout of the pump elements, Fig. 4

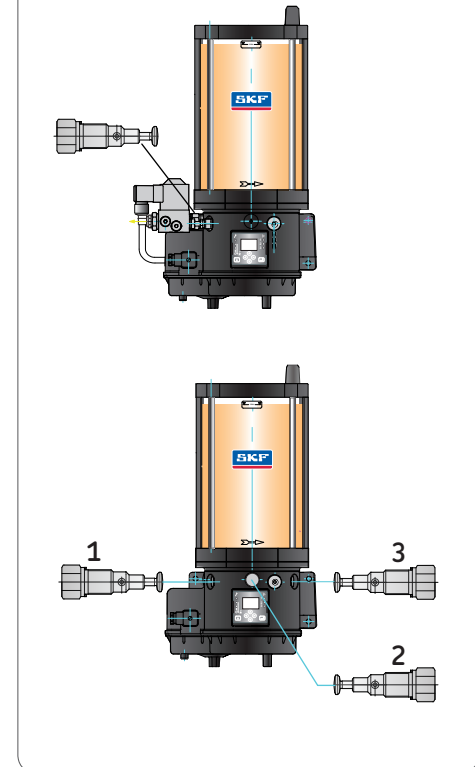

When ordering pump elements, the required delivery rate must be specified, as well as the design type (spring return pistons/ positively driven pistons).



Warning!

The two types of pump element, with spring return pistons and positively driven pistons, are not interchangeable!

Connection of the pump elements, Fig. 5

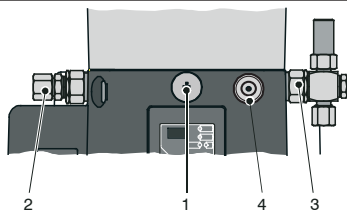

Connection for pump elements

- 1 Screw plug
- 2 Pipe connector
- 3 Pump element with pressure regulating valve
- 4 Lubricant nipple /filler socket

4.3.2 Pump elements with spring-return pistons

Pump elements with spring-return pistons			
Delivery rate ¹⁾ [cm ³ /min] [bar]	Number of grooves	Max. perm. oper. pressure	Order No.
5.0	0	200	KFG1.U0
2.5	1	300	KFG1.U1
1.8	2	300	KFG1.U2
1.3	3	300	KFG1.U3
0.8	4	300	KFG1.U4

1) The values given here apply for a temperature of 20 °C, back pressure of 50 bar and greases of NLGI Grade 2.

Spring-return pump element KFG1.U1 without pressure regulating valve, Fig. 6

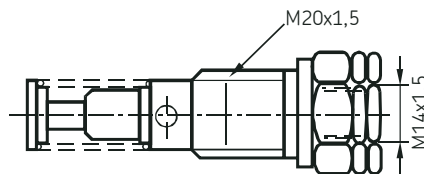

Optional pump element outlet G 1/4 "

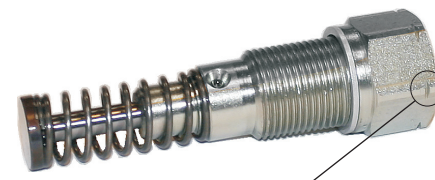

Marking grooves,
see table, column for number of grooves

4.3.3 Assembly of a pump element with spring return pistons

- Turn off pump unit.
- Unscrew and remove screw plug (KFG1.128)

Then perform the following:

- Loosen and remove pressure regulating valve (2) or lubrication line (3) on an already mounted pump element (1).
- Loosen and remove mounted pump element (1).
- Insert new pump element (1) into housing hole and twist in by hand
- Tighten pump element (1) at a torque of 35 Nm.
- Switch on pump and leave running until grease without bubbles discharges from the pump element outlet.
- Reconnect pressure regulating valve (2) or lubrication line (3) to the pump element (1) and tighten at a torque of 25 Nm.

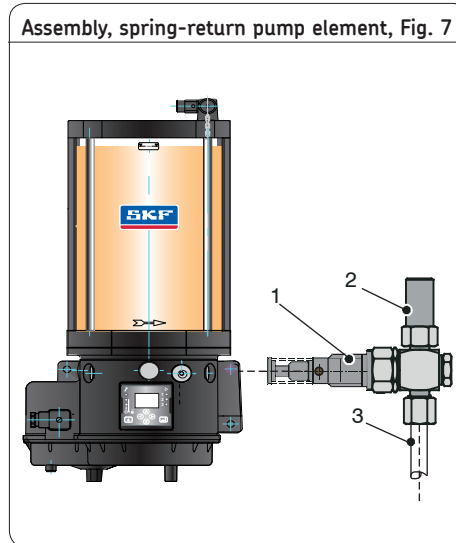

4.3.4 Pump elements with positively driven pistons

Pump elements with positively driven pistons

Delivery rate ¹⁾ [cm ³ /min]	Max. permiss. oper. pressure [bar]	Labeling	Order No.
5.0	250	L-0	KFG1.U0-E
2.5	350	G-1	KFG1.U1-E
1.8	350	H-2	KFG1.U2-E
1.3	350	J-3	KFG1.U3-E

1) The values given here apply for a temperature of 20 °C, back pressure of 50 bar and greases of NLGI Grade 2.

Positively driven pump elements G-1 without pressure regulating valve, Fig. 8

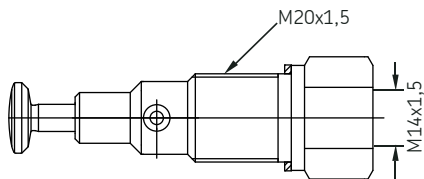

Optional pump element outlet G 1/4 " "



4.3.3 Assembly of a pump element with positively driven pistons

see Fig. 9

- Turn off pump unit.
- Unscrew and remove screw plug (KFG1.128)

Then perform the following:

- Loosen and remove pressure regulating valve (2) (or lubrication line (3) on an already mounted pump element (1).
 - Switch off the pump unit as soon as the pump element to be changed (1) begins pumping. (To position the eccentric ring).
 - **Section A** Disengage the installed pump element (1) and slowly unscrew it out
 - **Section B** After the final turn of the screw thread, slightly raise the pump element (1) so that the piston comes out of the eccentric ring (4)
 - Carefully pull the pump element (1) out of the housing bore (5), making sure that the piston (6) is not pulled out of the pump element
- ☞ If the piston does come loose while pulling out the pump element, remove it from the

housing bore with a bar magnet (or taper-nose pliers).

- **Section C** Carefully pull the piston (6) out of the new pump element (1)
- Coat the bore of the pump element lightly with grease
- Insert the piston in the bore of the pump element, leaving as much of the piston as possible protruding from the bore
- **Section D** Slowly insert the pump element (1) at an angle into the housing bore (5) until the piston bottoms out under the guide of the eccentric ring (4)
- Straighten the pump element (1) horizontally and screw it into the housing bore (5) by hand
- Tighten pump element (1) at a **torque of 35 Nm**.
- Switch on pump and leave running until grease without bubbles discharges from the pump element outlet.
- Connect pressure regulating valve (2) or lubrication line (3) to the pump element (1) and tighten at a **torque of 25 Nm**

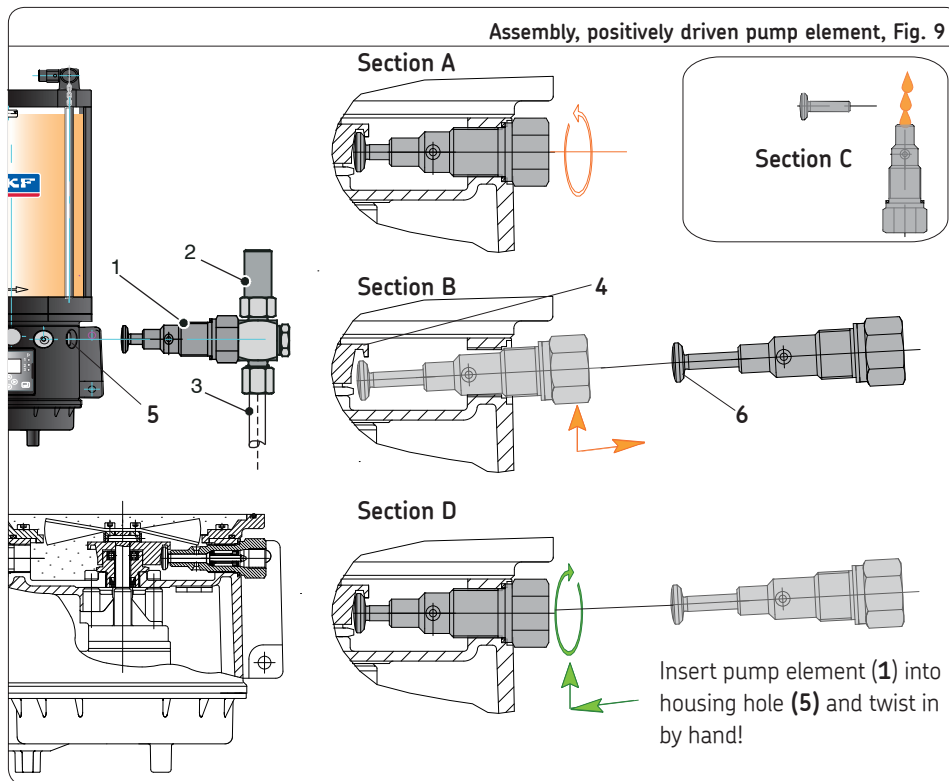

4.3.4 Pressure regulating valve

A pressure regulating valve (1) protects the entire lubrication system against excessive system pressure. It is mounted directly on the pump element (2). The cracking pressure set for this valve is 300 bar or 200 bar, depending on the valve design. If a blocked feeder or a lubrication point causes operating pressure to rise above 300 (200) bar, the valve opens, followed by a noticeable discharge of grease (3). This protects the pump unit against damage. At the same time, it functions as a way of visually monitoring the system. A further option are pressure regulating valves with an emergency lubricant nipple. These can be actuated manually to provide the lubrication system with adequate lubricant in case of power failure or a defective pump.

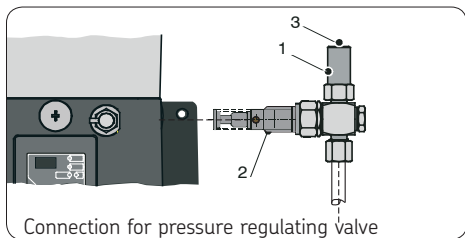

Pressure regulating valve

Pressure regulating valve without lubricant nipple

Tube Ø [mm]	Cracking pressure [bar]	Order number
6	300	161-210-012
6	200	161-210-049
8	300	161-210-018
8	200	161-210-050
10	300	161-210-035
10	200	161-210-051
G 1/4	300	161-210-036
G 1/4	200	161-210-059

Pressure regulating valve with lubricant nipple

6	300	161-210-014
8	300	161-210-025

Pressure regulating valve with pressure gauge

6	300	161-210-046
8	300	161-210-047
10	300	161-210-048

Pressure regulating valve, Fig. 10

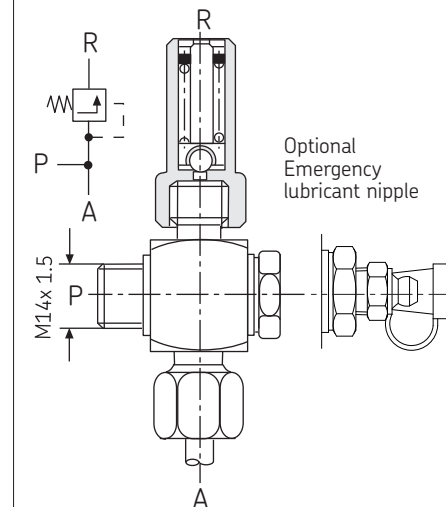

Connections for pressure regulating valves

- A Connection for pipe Ø
- P Pipe thread for pump element
- R Grease discharge at overpressure

Cracking pressure 300 ± 20 bar
Cracking pressure 200 ± 20 bar

Pressure regulating valve		
Pressure regulating valve with T connector output		
Tube Ø [mm]	Cracking pressure [bar]	Order number
6	300	161-210-038
6	200	161-210-032
8	300	161-210-039
8	200	161-210-031
10	300	161-210-016
10	200	161-210-030

4.4 Information on lubricant filling



Only fill using clean lubricant and an appropriate filling device. Contaminated lubricants can result in severe system malfunction.

4.4.1 Lubricant filling

The lubricant is filled on the housing via a lubricant nipple (1).

Lubricant can alternatively be filled via a filler coupling (see section 4.4.2).

Lubricant can optionally be filled via a filler socket (see section 4.4.3), which is likewise mounted on the reservoir housing. When filling in this way, make sure that air pockets do not form in the lubricant in the pump reservoir during the filling process.

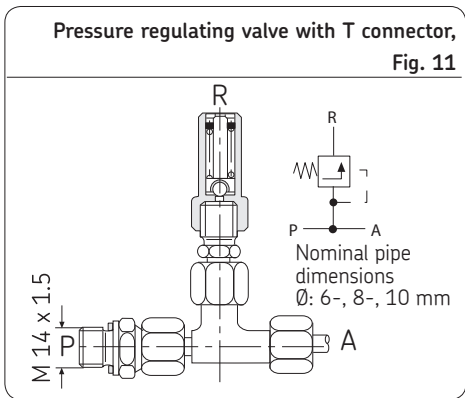

Filling, Fig. 12

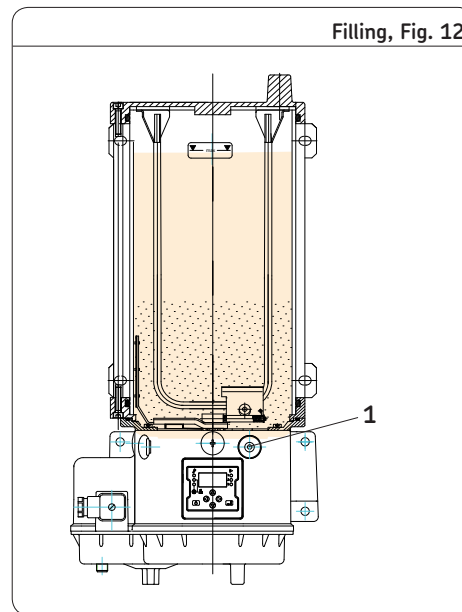

4.4.2 Filler coupling

As an alternative or in addition to the conical head nipple (1) the unit can also be fitted with a filler socket (part No. 995-000-705) (2) for filling by means of a filler pump.

A corresponding coupling socket (part No. 995-001-500) (3) must be mounted on the filling pump. The cap on the filler socket must be removed before filling.

Filling via filler coupling 13

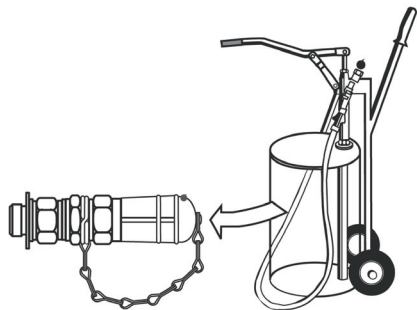

4.4.3 Filling cylinder

When used at very low temperatures, the pump unit can optionally be filled via one of the lubricant outlets using a filling cylinder (1). This is done by removing the screw plug M20 x1.5 (2) from the lubricant outlet and replacing it with a filler socket (part No. 169-000-174) (3). When filling, the caps (4) need to be removed from the socket and the filling cylinder.

Filling via filling cylinder 14

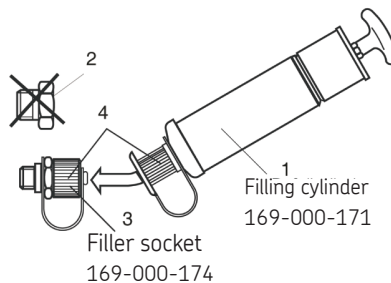

4.5 Electrical power supply



Warning!

Compare the operating voltage with the specifications on the rating plate.

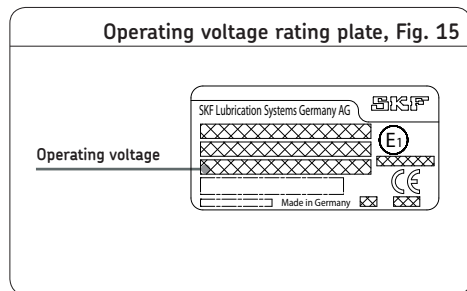

The pump units in the KFG series are available in voltage designs 12 VDC and 24 VDC. The electrical voltage connection is established through a 4-pin cable socket according to DIN EN 175301-803 or a 7-pin circular connector according to DIN 72585.

4.5.1 General conditions for electrical connections

KFG; KFGS; KFGL; KFGC, General conditions for electrical connections				
Nominal Voltage	Power consumption (load-dependent)	Power consumption (max.)	Pump starting current (ca. 20 ms)	Max. back-up fuse
12 VDC ¹⁾	2.4 A ²⁾	< 5 A	9 A	5 AT ³⁾ ⁴⁾
24 VDC ¹⁾	1.25 A ²⁾	< 2.5 A	4.5 A	3 AT ³⁾ ⁴⁾

KFGC (CAN bus)

Switching outputs:
 Max. current-carrying capacity:

- Type: Solid-state output, short-circuit-proof and overload-proof
- with simultaneous operation of 4 outputs 1.0 A
- with simultaneous operation of 2 outputs 1.25 A
- with operation of 1 output 1.5 A

Modes of operation:

- Single operation
- Parallel connection of multiple outputs while simultaneously increasing output current

Signal inputs:
 Connectivity:

- Type: digital solid-state input, short-circuit-proof
- Switching contact, no detection of wire breakage
- Dual wire sensors (e.g., piston detector), detection of wire breakage

- 1) Protective measures that must be applied for designated usage: **"Functional Extra Low Voltage"**, **"Protective Extra Low Voltage" (PELV)**
Standards: EN 60204 Part 1: IEC 60204-1: DIN VDE 0100 Part 410 / IEC 364-4-41: HD384.4.41
- 2) Typical value at ambient temperature = 25 °C and operating pressure = 150 bar
- 3) Fuse in accordance with DIN 72581 T.3
- 4) Conductor: cross-section 1.5 mm², length ≤ 12 m
- 5) No specification

4.6 KFG power supply and connections

The KFG pump unit is available in the voltage designs 12 VDC and 24 VDC. The electrical voltage connection is established through a 4-pin cable socket according to DIN EN 175301-803.

There may be an additional connector for fill level control on the pump housing, depending on the pump unit model. This is to be connected by the customer. The standard connections are presented below (variations possible in the case of special designs).

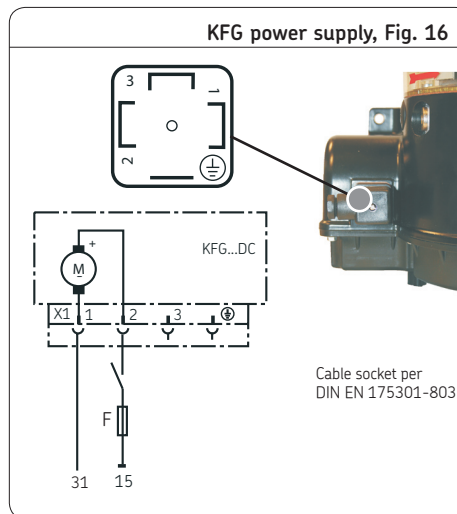

4.6.1 KFG power supply



Connector pin assignment 12/24 VDC

PIN	Description
1	⊖ (Ground) = 31
2	+ (Power) = 15 Supply voltage potential (ignition ON)

4.6.2 External control units

-  The external control units listed in Chapter 16 are designed to control the lubrication and interval times, as well as to monitor the lubrication process.
-  The operating instructions/functional description of the corresponding control unit must be observed.

4.7 KFGS power supply and connections

With integrated IG502 control unit

The electrical connection is a 7-pin plug-in connector on the base of the pump unit.

The pump control can run in the following control modes:

- Timer operation without system monitoring
- Timer operation with system monitoring
- Counter operation without system monitoring
- Counter operation with system monitoring

Depending on the pump unit design, an additional plug for fill level control can be integrated into the pump housing. The standard connections are presented below.

4.7.1 KFGS power supply

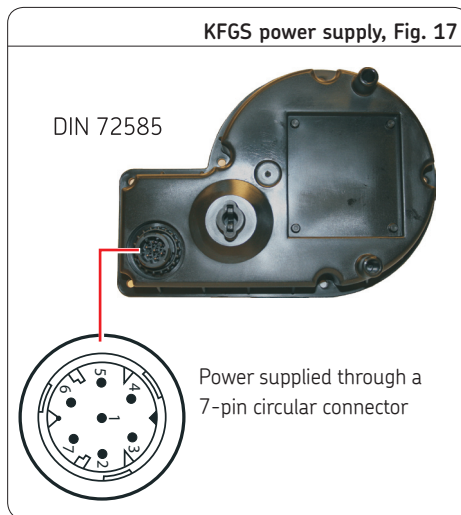

Connector pin assignment		
PIN	Color code	Conductor coloring
1	BN	Brown
2	RD-BK	Red-Black
3	BU	Blue
4	PK	Pink
5	BK	Black
6	BK	Black
7	VT-GN	Violet-green



Note!

The connector pin assignment varies depending on the operating mode. Therefore refer to the following examples for pin functions. Unneeded conductor ends on the cable set must be individually insulated and secured so that no short to ground can occur.

Accessories	
Description	Order No.
Wiring harness, in corrugated pipe, with socket-outlet on pump side	
8 m length	997-000-760
12 m length	997-000-630
16 m length	997-000-650

Programming:

- Chapter 9 of assembly instructions

Control using machine pulses

(Counter mode = load-dependent lubrication)

The duration of the interval time is determined by a pulse generator that sends pulses to the control unit based on how long the machine has been running. The control unit counts the pulses that are received and starts the pump after the pre-set number of pulses.

The pump cycle time is defined by a time value. Both the number of pulses that determine the interval time and the pump cycle time can be configured.

The fill level monitoring unit is internally connected to the integrated pump control unit. A fault notification can be sent to the process control level via indicator light SL2.

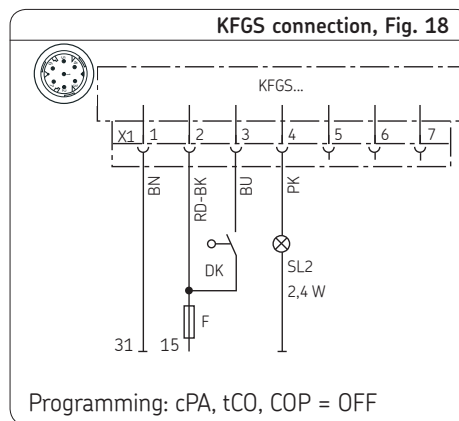
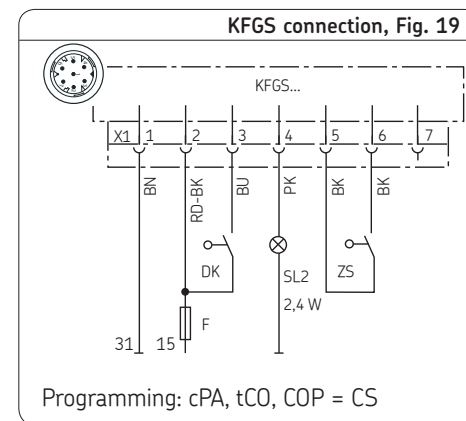

One pulse is counted each time the operating voltage is switched on when the pushbutton is closed in counter operation.

4.7.2 Connectivity**Counter operation without system monitoring****4.7.3 Connectivity****Counter operation with system monitoring****Connector pin assignment in counter operation**

PIN	Code	Assignment
1	31	- Supply voltage potential (0V, GND)
2	15	+ Supply voltage potential ("ignition ON")
3	DK	Pushbutton = 1. Interim lubrication, 2. Delete fault notification
4	SL2	"Fault" indicator light
5	ZS	Piston detector „+“
6	ZS	Piston detector "Signal"
7	SL1	"Pump ON" indicator light

Programming:

- see Chapter 9 of with assembly instructions

Timer mode

In timer mode, the interval time is determined by a time value. It is configured by entering a time value in hours.

The pump cycle time is configured using a time value in minutes.

The fill level monitoring unit (W1 control) is internally connected to the integrated pump control unit. A fault notification can be sent to the vehicle control/electronics system via indicator light SL2.

4.7.4 Connectivity

Timer operation without system monitoring

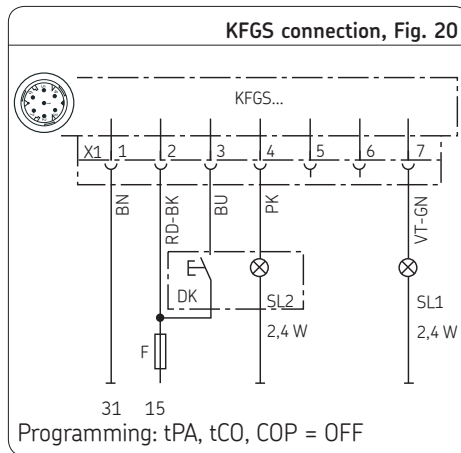

4.7.5 Connectivity

Timer operation with system monitoring

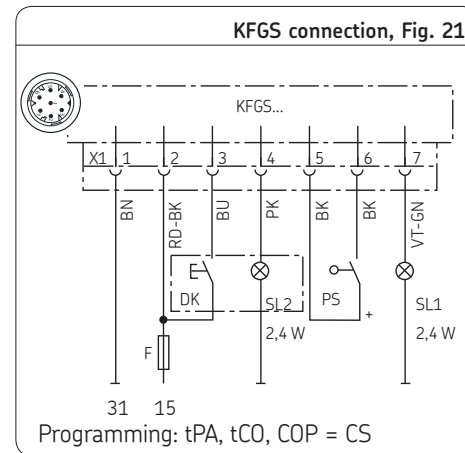

Connector pin assignment in timer operation

PIN	Code	Assignment
1	31	- Supply voltage potential (0 V, GND)
2	15	+ Supply voltage potential "ignition ON"
3	DK	Pushbutton "1. Interim lubrication" "2. Delete fault notification"
4	SL2	"Fault" indicator light
5	ZS	Piston detector „+“
6	ZS	Piston detector "Signal"
7	SL1	"Pump ON" indicator light

4.8 KFGL power supply and connections

With integrated LC502 control unit

The KFGL pump unit can be fitted with a fill level switch of one of the following types for indication of the "Minimum" fill level:

- Order code 1 (formerly W1 control) for greases of NLGI ≥ 2
- Order code 2 (formerly W1G control) with signal smoothing, for greases of NLGI ≥ 2

The fill level switch in question is connected internally to the pump control system.

The standard connections are presented below.

4.8.1 KFGL power supply

KFGL power supply, Fig. 22

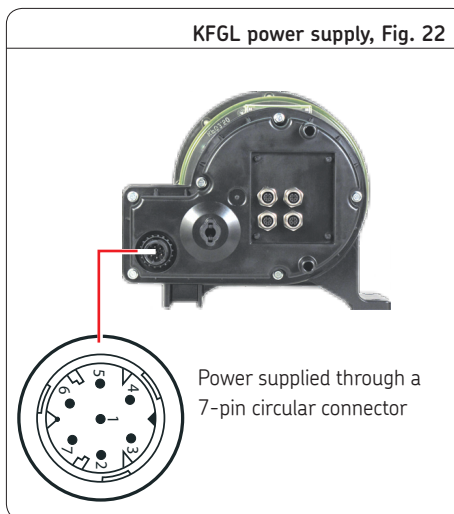

Connector pin assignment

PIN	Color code	Conductor coloring
1	BN	Brown
2	RD-BK	Red-Black
3	BU	Blue
4	PK	Pink
5	BK	Black
6	BK	Black
7	VT-GN	Violet-green

Accessories

Description	Order No.
Wiring harness, in corrugated pipe, with socket-outlet on pump side	
8 m length	997-000-760
12 m length	997-000-630
16 m length	997-000-650

4.8.2 KFGL ProFlex for progressive centralized lubrication systems

KFGL ProFlex, Fig. 23

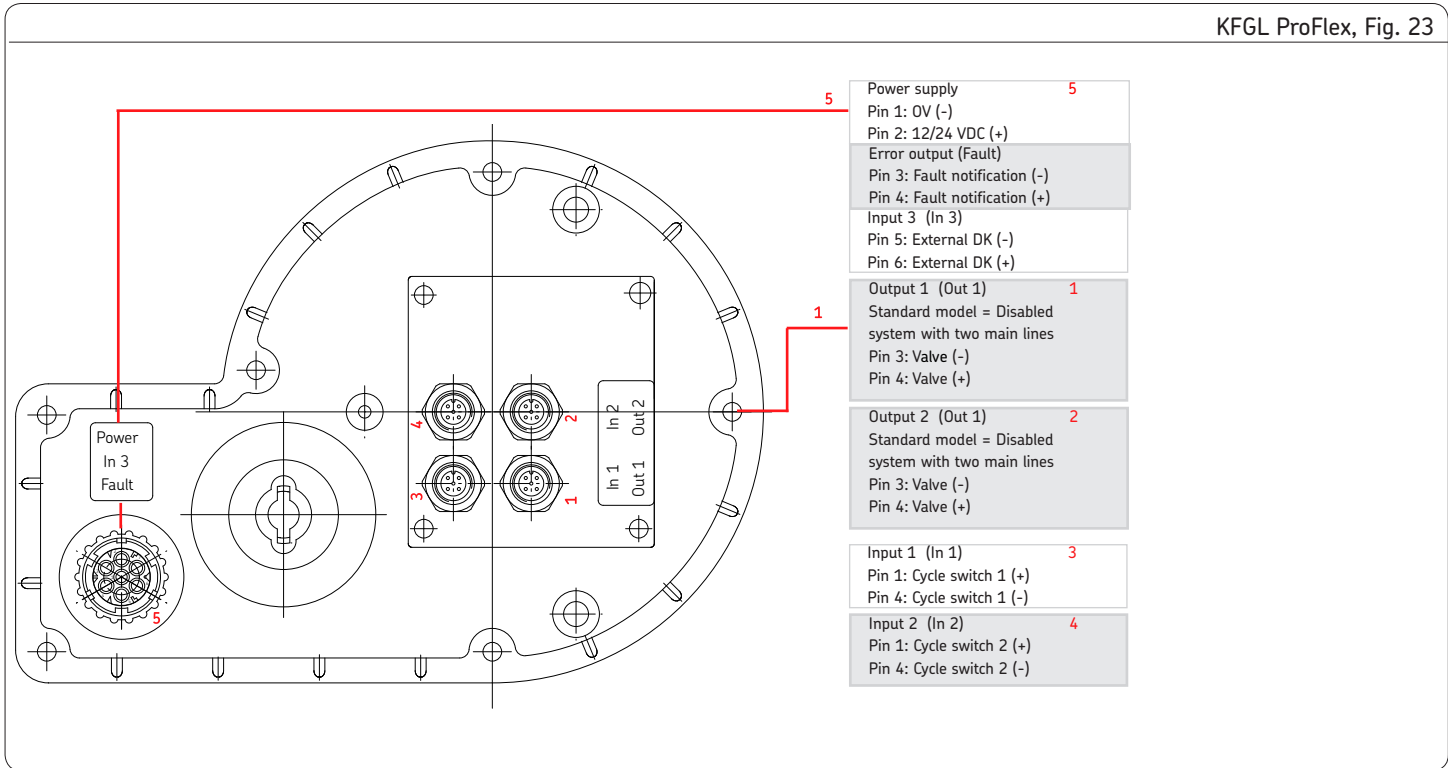

4.8.3 KFGL MonoFlex for single-line lubrication systems

KFGL MonoFlex, Fig. 24

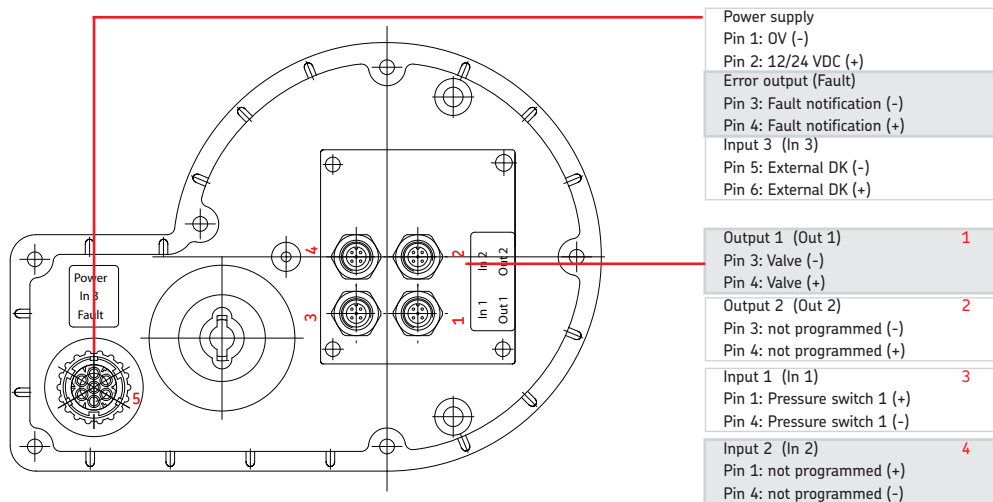

4.9 KFGC power supply and connections

With integrated LC-CAN5000 control unit

In this version, the electrical connection is a 7-pin plug-in connector on the base of the pump unit. There is also a 3-pin Deutsch connector on the underside for the CAN bus connection. Up to six circular connectors can also be attached to control the reversing valves and sensors.

4.9.1 Power supply

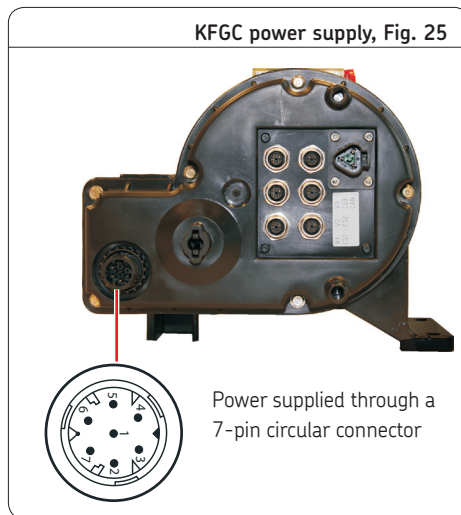

Connector pin assignment of power supply

PIN	Color code	Function
1	BN Brown	31 m
2	RD-BK Red-Black	15 +
3	BU Blue	MC+/CS4+
4	PK Pink	MC-/CS4-
5	BK Black	VT4 +
6	BK Black	Vt4 -
7	VT-GN Violet-green	NC

Accessories

Description	Order No.
Wiring harness, in corrugated pipe, with socket-outlet on pump side	
8 m length	997-000-760
12 m length	997-000-630
16 m length	997-000-650



Unneeded conductor ends on the cable set must be individually insulated and secured so that no short to ground can occur.

KFGC CAN connector, Fig. 26

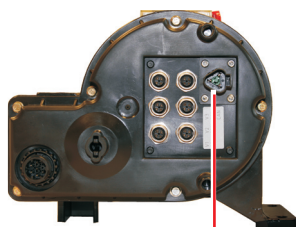

CAN bus connection,
plug type DEUTSCH
DT04-3P-L012

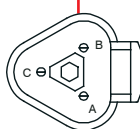

M12x1 connector, Fig. 27

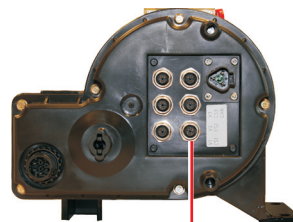

Reversing valve/piston
detector connection
(max. 6 connections)

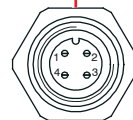

Accessories for reversing valve/piston detector

Description	Order No.
Wiring harness for pressure relief valve on pump side, approx. 0.4 m	179-990-847
Wiring harness for piston detector or pressure switch, approx. 5 m	179-990-719

CAN bus connector pin assignment

PIN	Color code	Function
A	YE Yellow	CAN_H
B	GN Green	CAN-B
C	BK Black	CAN-SHLD

Reversing valve/piston detector connector pin assignment

PIN	Color code	Input CS2/CS3	Output VT1 to VT3
1	BN Brown	+	NC
2	WH White	NC	NC
3	BU Blue	NC	-
4	BK Black	-	+

4.9.2 Connectivity

Example of the connection of four reversing valves and four piston detectors for units with maximum configuration (6x circular connectors M12x1 available) for the operation of a progressive feeder system, divided into four lubrication segments

 Customer-specific variations are possible.

Legend for maximum configuration connection example

- CS1 – CS4** Piston detector 1 – 4
- V1 - V4** Valves 1-4
- MC** Machine contact
- SL2** "Fault" indicator light
(can be operated as an alternative in place of valve 4)
- L+** + Supply voltage potential
- S1** Ignition switch
- F1** Fuse

Maximum configuration example, Fig. 28

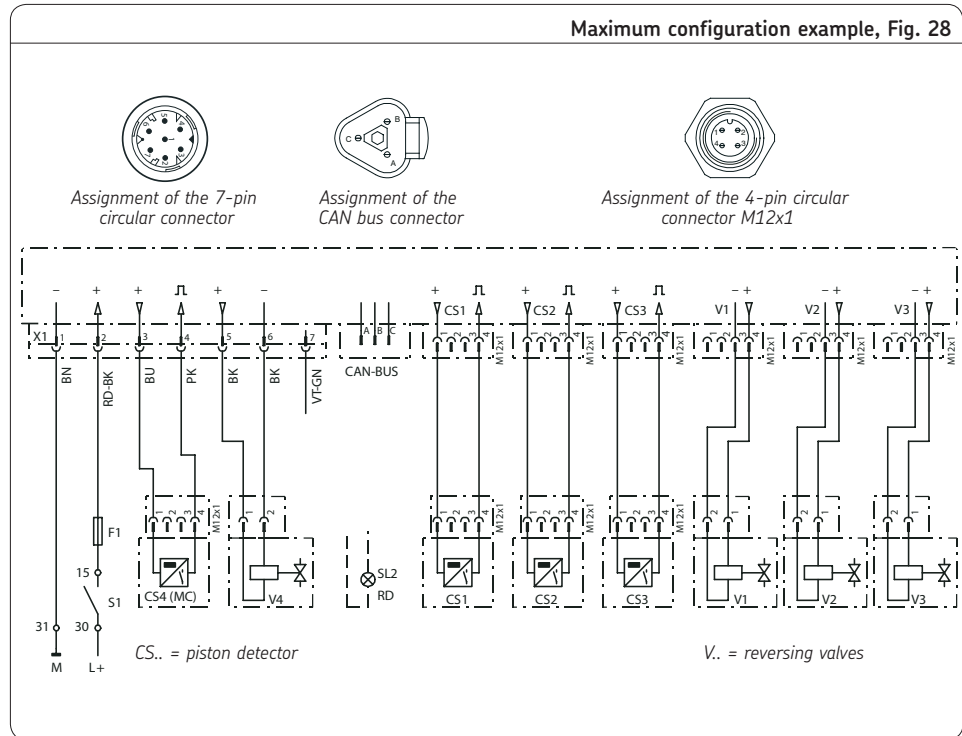

Example of the connection of a piston detector or machine contact and a reversing valve on a unit with minimum configuration (without circular connector M12x1) for operation of a progressive feeder system, no division into lubrication segments.

Legend for minimum configuration connection example

- CS4** Piston detector 4
- V4** Valves 4
- MC** Machine contact
- SL2** "Fault" indicator light
(can be operated as an alternative in place of valve 4)
- L+** + Supply voltage potential
- S1** Switch
- F1** Fuse

Minimum configuration example, Fig. 29

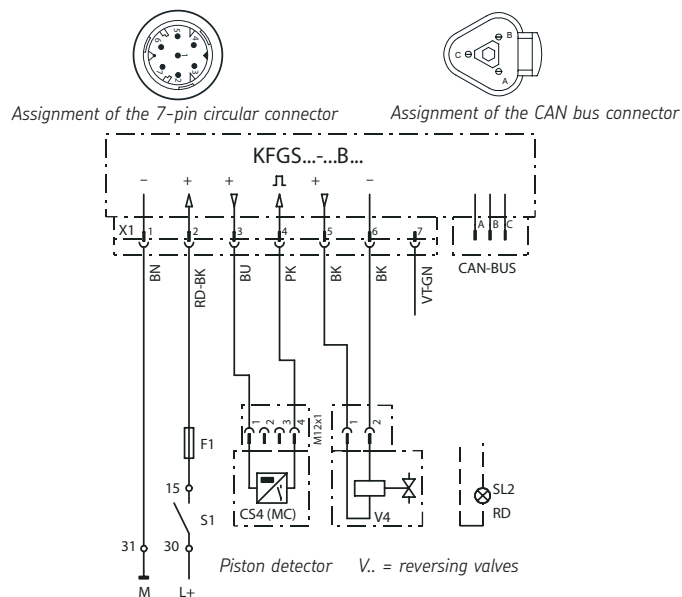

4.10 Pressure relief valve with integrated pressure regulating valve

(for single-line systems with VR distributors)

Technical data

Pressure relief valve 12 VDC / 24 VDC

Input voltage	12 VDC	24 VDC
Rated output	26 W	26 W
Rated current	2,18 A	1.2 A
ON-time (at 35 °C)	100%	100%
Protection class	IP 65	IP 65

Pressure regulating valve

Set pressure 200 bar¹⁾

Plug-in connection per DIN EN 175301803

Pressure relief valve 230 VAC

Input voltage	230 VAC
Coil voltage	205 VDC
Rated output	26 W
Rated current	0.13 A
ON-time	100% at 35 °C

Pressure regulating valve

Set pressure 200 bar

Protection class IP 65
 Plug-in connection per DIN EN 17530-803

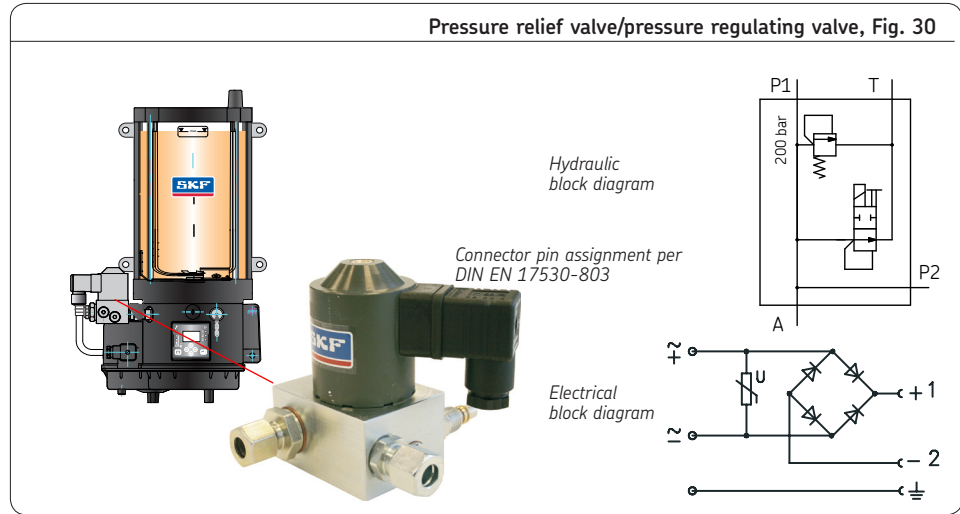

Note!

When VKR distributors are used, a max. set pressure of 130 bar for the pressure regulating valve must not be exceeded.

Connector pin assignment

PIN	Description
1	= \oplus (Current) Supply voltage potential
2	= \ominus Ground
3	= $\opl�$ PE

1) Pressure relief valve with set pressure 130 bar on request

4.11 Fill level monitoring

Two different fill level switches can be fitted as standard on the KFGS and KFGL pump units for the purpose of indicating the “Minimum” lubricant fill level

- Order code 1 (formerly W1 control) for greases of NLGI ≥ 2
- Order code 2 (formerly W1G control) with signal smoothing, for greases of NLGI ≥ 2

With pump design KFG (without control unit) with fill level monitoring the monitoring signals are processed by a system provided by the customer;

in the KFGS and KFGL versions the monitoring switch is connected to the pump's control system. This effectively prevents the fill level from falling below the minimum, thus preventing any damage to the KFG pump units which could result from that.

On KFGC pump units, fill level control is customized according to customer specifications.



4.11.1 Order code 1 (W1)

max. 24 VDC, for greases of NLGI Grade ≥ 2

Functional description

The fill level switch W1 is designed as a rocker switch integrated in the base of the reservoir. A magnetic rocker mounted on the agitator is pushed down by resistance from the grease when the reservoir is full. A pulse is generated with every revolution of the agitator. When the minimum fill level is reached, the resistance from the grease on the rocker gives way. The rocker then snaps back up and the pulse is interrupted.

Technical data

Fill level monitoring	
Function	Mechanical, by dry reed contact
Contact form	NO-contact
Switching capacity, max.	0.6 W
Switching voltage, max.	24 VDC
Switched current, max.	25 mA;
	resistive load only ¹⁾
Plug-in connection	DIN EN 60947/IEC 947 ²⁾
Wiring diagram	Circular connector M12x1

1) No inductive load, no lamp load (indicator lamp)

2) Cable socket - see Accessories Chapter 16

4.11.2 Order code 2 (W1G)

with dry contact, signal smoothing,
max. 24 VDC, for greases of NLGI Grade ≥ 2

The following functions are integrated for the KFG pump unit with signal smoothing:

- Possible isolation of power supply voltages between fill level monitoring and pump power.
- Fill level information can be accessed even during interval time.
- Reverse voltage protection provided in the pump supply line.
- Optional timeout times.

The various functions are realized internally using jumpers, according to the customer-specific pump design.

The monitoring device is connected via a 4-pin circular connector, which is plugged into the base of the pump unit.

Technical data

Fill level monitoring
Function Dry (potential-free) or non-dry contact, depending on version

With dry contact:

Contact form Changeover
Switching capacity, max. 60 W
Switching voltage, max. 30 VDC

Non-dry contact:

Operating voltage 10 to 30 VDC
Continuous current ≤ 200 mA
Internal power consumption . . 6 to 12 mA
Voltage drop ≤ 1.8 V at I_{Term}

Plug-in connection DIN EN 60947/IEC 947¹⁾
Wiring diagram Circular connector M12x1

1) Cable socket - see Accessories, Chapter 16

4.11.3 KFG connection with fill level monitoring, order code 1 and 2

The standard model of the KFG pump unit is not fitted with fill level monitoring.

KFG models with fill level monitoring need to be connected to an external system (provided by the customer) because there is no control system to process the signals. In this optional version, the cubical plug fitted on the side is replaced by a 7-pin connector fitted on the bottom of the KFGS and KFGL. The following lists the pin assignment for the fill level switches with order codes 1 (W1) and 2 (W1G).

Connection, fill level monitoring, W1/W1G,
Fig. 30



Type: W1

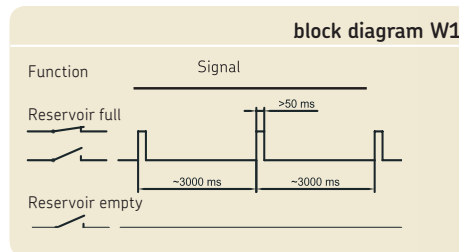

Connector pin assignment W1 (pump unit)

PIN	Description
1 =	31 - Supply voltage potential (0V, GND)
2 =	15 + Supply voltage potential
3 =	Not assigned
4 =	Not assigned
5 =	+ Potential
6 =	Signal (pulses)
7 =	Not assigned

Type: W1G

Connector pin assignment W1G (pump unit)

PIN	Description
1 =	31 - Supply voltage potential (0V, GND)
2 =	15 + Supply voltage potential
3 =	NC (pin 5 and pin 3 closed, reservoir empty)
4 =	NO (pin 5 and pin 3 closed, reservoir full)
5 =	COM (+ potential)
6/7 =	Not assigned

4.11.4 Pump unit fill level control

Visual

The transparent lubricant reservoir allows for visual fill level control. This must be performed on a regular basis for safety reasons.



Note!

The entire system must be ventilated if the reservoir has been emptied below the "min" mark.

Automatic

Pumps of the KFGS series allow for automatic fill level control. If the fill level falls below the "min" mark, the lubrication process is stopped and the fault notification "FLL" is issued on the display.

4.12 Lubrication line connection

The lubrication line must be connected to the lubrication unit in such a way that no forces can be transferred to the assembled lubrication unit (stress-free connection).



Warning!

The fittings used to connect the lubrication line should be rated for the maximum operating pressure of the lubrication unit. If they are not, the lubrication line system needs to be protected from excessive pressure by means of a pressure-limiting valve.

For higher operating pressures up to 250 bar as can occur especially in progressive centralized lubrication systems, SKF cutting-sleeve screw unions conforming to DIN 2353 can be used. If using fittings from other manufacturers, pay careful attention to the assembly instructions and technical specifications provided by the manufacturer.

4.13 Lubrication line arrangement

The pipes, tubes, shutoff valves and directional control valves, fittings, etc. that will be used must be designed for the maximum operating pressure of the lubrication unit, the permissible temperatures and the lubricants that will be delivered. Furthermore, the lubrication line system needs to be protected from excessive pressure by means of a pressure-limiting valve.

All components of the lubrication line system such as pipes, tubes, shutoff valves, directional control valves, fittings, etc. must be carefully cleaned before assembly. No seals should point inward in the lubrication line system, as this could hinder lubricant flow and introduce contaminants into the lubrication line system. Lubrication lines should always be arranged so that air pockets cannot form anywhere. Avoid changes in the cross-section of the lubrication line from small to large cross-sections in the direction of flow of the lubricant. When the cross-section does change, the transition should be gentle.

4.14 Progressive system ventilation

- Fill pump with lubricant.
- Remove main lines on unit.
- Allow pump to run until lubricant without bubbles is discharged at the straight connector of the pump element.
- Mount main lines.
- Allow pump to run until grease can be seen discharging at all lubrication points.

4.15 Single-line system ventilation

- Fill pump with lubricant.
- Remove main lines (pressure relief valve as necessary) on unit.
- Allow pump to run until lubricant without bubbles is discharged at the straight connector.
- Mount main lines.
- Remove screw plug or pressure switch at end of main and branch lines.
- Allow pump to run until air is no longer discharged at the end of the line sections.
- Mount screw plug or pressure switch.
- Vent lubrication lines and lubrication points and inspect for proper function.

4.16 Note on the rating plate

The rating plate of pump units KFG and KFGL displays important specifications such as type designation and short material description (or customer number).

To avoid loss of this data in case the rating plate becomes illegible, these characteristics should be entered in the following table.

- Enter key data from rating plate in the following table.

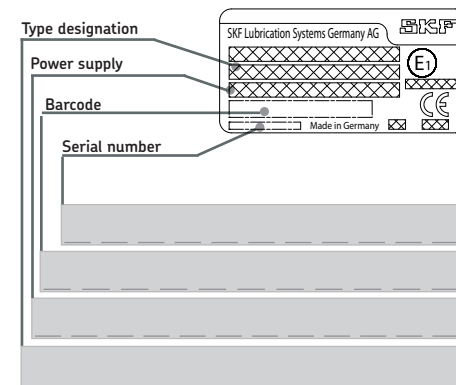

**KFG; KFGS; KFGL; KFGC for
vehicle lubrication**

**Operating instructions associated
with assembly instructions**
according to EC Dir. 2006/42/EC for partly completed machinery

1. Safety instructions

1.1 General information



Warning!

These operating instructions must be read and properly understood by the assembler and the responsible technical personnel/operator before assembly and commissioning.

The safety instructions listed in Chapter 1, "Safety instructions," of the assembly instructions also apply without restrictions to these operating instructions.



In addition to the operating instructions, general statutory regulations and other binding regulations for accident prevention and for environmental protection (recycling/disposal) must be observed and applied.

1.2 Disclaimer of liability

SKF Lubrication Systems Germany AG shall not be held liable for damages:

- Caused by contaminated or unsuitable lubricants
- Caused by the installation of non-original SKF components or SKF spare parts
- Caused by inappropriate usage
- Resulting from improper assembly, configuration or filling
- Resulting from improper response to malfunctions
- Caused by independent modification of system components
- Only media approved for these types of pump units may be used. Unsuitable media may result in pump unit failure and potentially severe bodily injury and property damage.

2. Lubricants



Warning!

The information on lubricants listed in Chapter 2, "Lubricants," of the assembly instructions also applies without restrictions to these operating instructions.

3. Transport, delivery, and storage

SKF Lubrication Systems Germany AG products are packaged in accordance with standard commercial practice according to the regulations of the recipient's country and DIN ISO 9001. During transport, safe handling must be ensured and the product must be protected from mechanical effects such as impacts. The transport packaging must be marked "Do not drop!"



Warning!

The product must not be tilted or dropped.

There are no restrictions for land, air or sea transport. After receipt of the shipment, the product(s) must be inspected for damage and for completeness according to the shipping documents. The packaging material must be preserved until any discrepancies are resolved.

SKF Lubrication Systems Germany AG products are subject to the following storage conditions:

3.1 Lubrication units

- Ambient conditions: dry and dust-free surroundings, storage in well ventilated dry area
- Storage time: max. 24 months
- Permissible humidity: < 65%
- Storage temperature: 10 - 40°C
- Light: avoid direct sun or UV exposure and shield nearby sources of heat

3.2 Electronic and electrical devices

- Ambient conditions: dry and dust-free surroundings, storage in well ventilated dry area
- Storage time: max. 24 months
- Permissible humidity: < 65%
- Storage temperature: 10 - 40°C
- Light: avoid direct sun or UV exposure and shield nearby sources of heat

3.3 General notes

- The product(s) can be enveloped in plastic film to provide low-dust storage.
- Protect against ground moisture by storing on a shelf or wooden pallet.
- Bright-finished metallic surfaces, especially wearing parts and assembly surfaces, must be protected using long-term anti-corrosive agents before storage.
- At approx. 6-month intervals: Check for corrosion. If there are signs of corrosion, reapply anti-corrosive agents.
- Drives must be protected from mechanical damage.

4. Assembly

4.1 Information on assembly

The assembly procedure for KFG pump units is described in detail in the assembly instructions associated with these operating instructions. Information/instructions about assembling the KFG (S) (L) (C) pump units beyond the scope of the assembly instructions are contained later in this chapter.

4.2 Assembly procedure for KFG (S) (L) (C) pump

- Assembly must be performed in accordance with the included assembly instructions and the additional information/instructions contained in this chapter.

5. Design and function

5.1 General information

Pump units of the KFG, KFGS, KFGL and KFGC series are electrically driven reservoir pump units (piston pumps) available with and without an integrated control unit. The pump ensures demand-based supply of lubricant to centralized lubrication systems with progressive feeders or single-line distributors on machines, systems, and vehicles.

The pump units differ in terms of the size and type of lubricant reservoir, the lubricant filling and their control and function monitoring.

Powerful CAN bus control system variants allow one unit and a special valve to supply up to four independent zones according to demand.

Note!

The exact pump designation of the CAN bus version consists of the particular order code and begins with the KFGC designation. This pump design is listed below under the KFGC designation for the sake of simplifying the descriptions.

5.2 Design

Pump units of the KFG, KFGS, KFGL and KFGC series are characterized by their compact construction and are divided into the assemblies for pump housing, lubricant reservoir, control unit, and fill level monitoring. A short description of the individual assemblies follows below.

5.2.1 Pump housing

The pump housing contains, among other things, the pump drive, control unit (KFGS, KFGL, KFGC) and three lubricant outlets for installing a maximum of three pump elements. One pressure regulating valve can be attached to each pump element. When used in single-line systems, a pressure relief valve with an integrated pressure regulating valve is attached to the pump element (max. 2 lubrication zones per pump with KFGL).

An optional filler socket can be installed on the pump housing as an alternative to the conical head nipple, to allow filling of the pump when used at low temperatures.

A grease return can also be attached. A display and control screen is mounted on the front side of the KFGS or KFGL design, while the KFGC design has a display attached. An IrDA interface is integrated into this, which can optionally be used to program the pump.

5.2.2 Lubricant reservoir

The lubricant reservoir is available in 2 kg, 6 kg, 10 kg, 15 kg and 20 kg sizes. The reservoirs are made of transparent plastic and have fill level markings that allow the fill level to be monitored visually.

The pump fill level can be monitored either via an integrated rocker switch or by an inductive fill level switch fitted on the lid.

5.2.3 Fill level monitoring

There is a choice of two fill level switches for monitoring of the minimum pump fill level. Fill level control W1 (order code 1) and fill level control W1G (order code 2) are used with lubricants up to NLGI Grade 2. The difference between the two fill level controls is that fill level control W1G is equipped with signal smoothing and a dry (potential-free) contact. The output signal is confined to the following indications:

- Reservoir full
- Reservoir empty

5.2.4 KFGS and KFGL control units

Pump units of the KFGS series are equipped with an IG502-2-I integrated control unit with a control display. Parameters for interval times (timer), interval pulses (counter) and pump cycle times (contact) can be entered through the control unit.

The KFGL's control unit, model LC502, allows up to three lubrication zones to be lubricated independently. Sectional lubrication is available

for differing lubricant requirements; the lubrication lines can be controlled and monitored individually.

5.3 KFG pump units

Pump units of the KFG series are reservoir pump units without an integrated control unit. The KFG pump is available in the versions with grease reservoir and in reservoir capacities 4 kg, 6 kg, 10 kg, 15 kg, and 20 kg. With the KFG pump unit, the fill level signal must be processed by a system supplied by the customer. The pump is available in various voltage designs.

On pumps for single-line systems, an electrical pressure relief valve is additionally installed on the pump housing, which ensures that pressure is relieved as required after the feeding operation.

5.4 KFGS pump units

Pump units of the KFGS series are reservoir pump units with an IG502-2-I integrated control unit with a control display. Parameters for interval times (timer), interval pulses (counter) and pump cycle times (contact) can be entered through the control unit.

A piston detector is used to monitor the feeding operation on progressive systems.

The KFGS pump is available in the same reservoir capacities and voltage designs as the KFG series.

The fill level of the pump units is monitored using the fill level switches mentioned in Chapter 5.2.3 (operating instructions) and Chapter 4 (in the assembly instructions).

The signals from minimum fill level monitoring are processed by the integrated KFGS control unit.

5.5 KFGL pump units

Pump units of the KFGL series are reservoir pump units with an LC502 integrated control unit with a control display. The control unit is pre-programmed with standard settings and easy to operate

The control unit can be used to set the pump run time either:

- based on pump speed
- based on time (hours and minutes) or machine cycles (load-dependent)

Sectional lubrication is available for differing lubricant requirements; the lubrication lines can be controlled and monitored individually. The LC502 also offers a wide range of options for monitoring functions and processes, with up to three lubrication zones able to be monitored independently.

The LC502 is fitted with integrated temperature overload protection and continuous system monitoring with fault detection and fault analysis.

A piston detector is used to monitor the feeding operation on progressive systems; a pressure switch is used for single-line systems.

The KFGL pump is available in the same reservoir capacities and voltage designs and with the same grease follower plates as the KFG/KFGS series.

The fill level of the pump units is monitored using the fill level switches mentioned in Chapter 5.2.3 (operating instructions) and Chapter 4 (in the assembly instructions).

The signals from minimum fill level monitoring are processed by the integrated KFGL control unit.

5.6 KFGC (CAN bus)

Pump units of the KFGC series are pump units from the KFG series with an integrated CAN bus control unit.

The integrated LC-CAN 5000 control unit offers the following special features:

- CAN bus interface (SAE J1939), which allows units to be seamlessly integrated into the CAN bus networks.
- The lubrication system can be monitored, operated and configured through the CAN bus.
- The pump can optionally be configured and operated via the IrDA interface.

Moreover, the control unit is able to control and monitor up to four independent zones and to supply them from a single pump unit.

To achieve this capability, electric switch valves which are controlled based on the parameters set for each individual lubrication zone are placed in the main line. The control unit has up to four solid-state switching outputs for this purpose.

In addition to valve control, the outputs can also be configured as digital outputs for other purposes.

In addition to the above-mentioned outputs, up to four digital inputs are available, e.g., for connecting piston detectors, pressure switches or other switching contacts. A detailed description of the electrical connections can be found in Chapter 4 in the assembly instructions.

The control unit's comprehensive monitoring functions allow potential faults to be detected early. This includes, among other things, monitoring the fill level in the lubricant reservoir (minimum), monitoring the signal lines on attached components for line breakage, and monitoring the switching outputs for short circuits.

Important system events such as a low fill level in the lubricant reservoir (minimum) are saved by the control unit and given a time stamp.

This allows the causes of operational faults to be determined more easily.

The flexible parameters and configuration options allow custom lubrication concepts to be implemented for each individual lubrication zone in the system. The control unit can store up to 16 sets of parameters. Each set of parameters contains all the information required to control and monitor the lubrication process. This means that different lubrication scenarios can be prepared and saved then called on when needed.

Chapter 4 in the assembly instructions contains instructions on configuring the system. You can find further descriptions of the SKF-KFGC-CAN bus system under the document numbers 951-170-205 or in the CAN bus control system description 951-130-502-EN.

6. Functional description in progressive systems

6.1 Functional description for progressive systems with a KFG pump unit

A general progressive feeder system consists of the following components:

- Pump unit with pump element and pressure regulating valve
- Lubrication lines, consisting of main and possibly branch lines, as well as
- Progressive feeders.

When the pump motor is turned on, the piston pump delivers lubricant from the lubricant reservoir to the lubricant outlet. The pump element attached to the outlet delivers the lubricant further, into the downstream main line. The lubricant flows through the main line to the progressive feeder. There, the lubricant is distributed according to the volume required by the lubrication point being supplied.

In progressive systems with a master feeder and secondary feeder, the lubricant coming from the pump unit is delivered to the master feeder. The master feeder distributes the lubricant to the secondary feeders according to their individual volume requirements. From there, the lubricant flows to the lubrication points.

6.1.1 Pump element

The pump element or elements meter out the lubricant and convey it to the downstream lubrication points or distributors. Five different pump elements are available for the range from 0.8 to 5 cm³/min, according to the lubricant volume required (see sections 4.3.2 and 4.3.4 in the assembly instructions).

Layout of the pump elements, Fig. 1

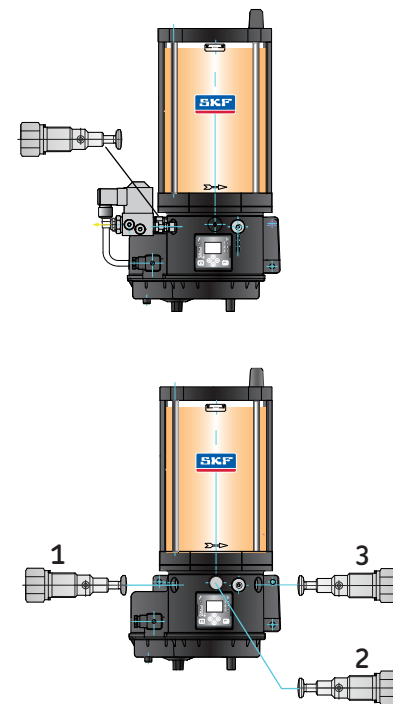

6.1.2 Pressure regulating valve

A pressure regulating valve can be installed on the pump element on progressive systems to prevent excessive operating pressure in the lubrication system. If the operating pressure exceeds the cracking pressure of the pressure regulating valve (see Technical Data, Chapter 4.3.4 in the assembly instructions), the valve opens and the lubricant flows back (on versions with a return line) into the lubricant reservoir.

Pressure regulating valve, Fig. 2

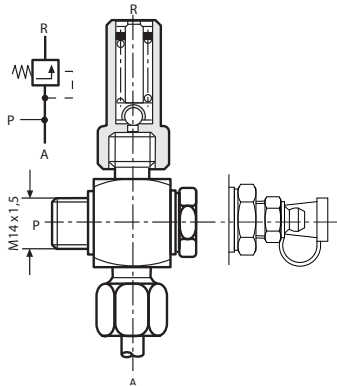

Example of progressive system with KFG pump unit, Fig. 3

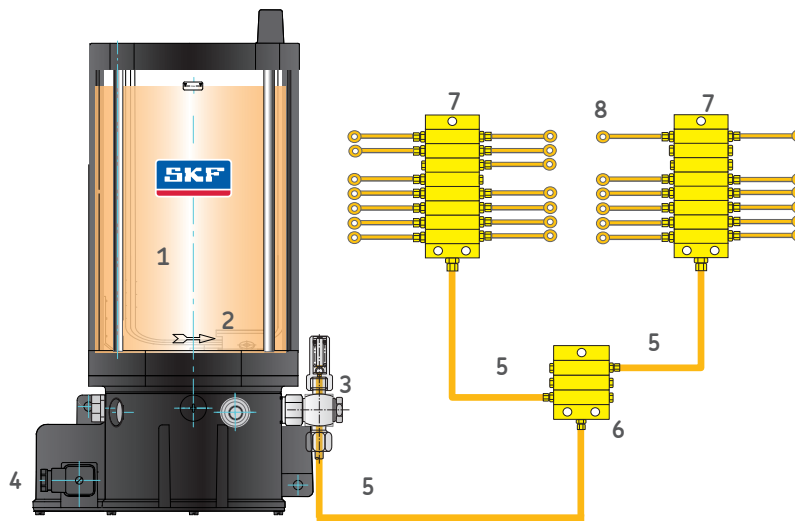

Progressive system with KFG pump unit

- | | | | |
|---|---|---|--------------------|
| 1 | KFG unit | 5 | Lubrication lines |
| 2 | Fill level switch | 6 | Master feeder |
| 3 | Pump element with pressure regulating valve | 7 | Secondary feeder |
| 4 | Electrical pump connection | 8 | Lubrication points |

6.2 Progressive system with a KFGS or KFGL pump unit

The general functional description for progressive systems with a KFG pump unit also applies for the design with KFGS and KFGL pump control.

The control unit integrated into the pump housing allows the following additional configuration, monitoring and connectivity options:

- Interval time and pump cycle time can be adjusted independently, including on monitored systems
- Recording of remaining intervals and remaining lubrication times
- Data backup in case of voltage failure
- Non-volatile memory with PIN code protection
- Connectivity for inductive piston detector to monitor the feeder function
- Connectivity for external pushbutton
- Internal fill level monitoring, lubrication cycle stop and fault notification remain on display in case the level falls below minimum
- Fault memory

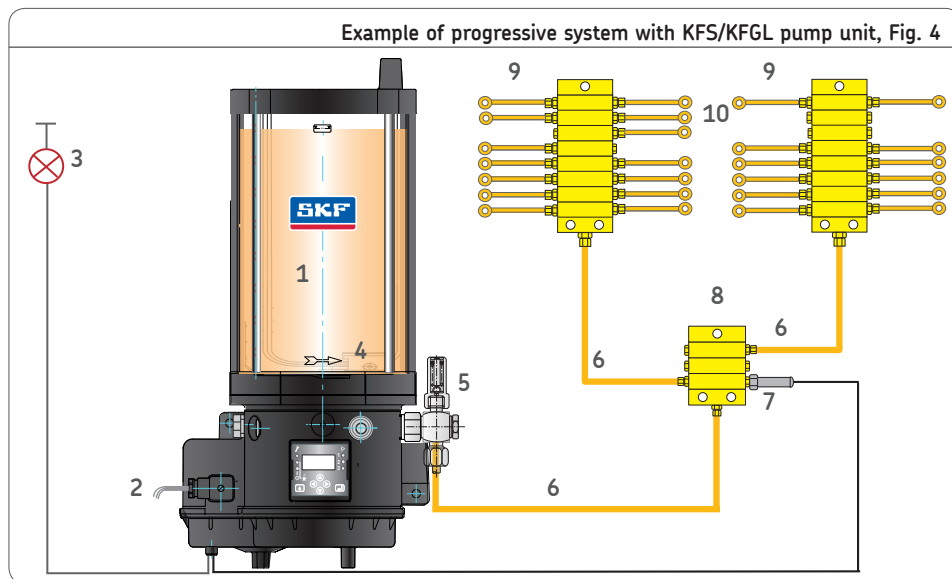

Progressive system with piston detector

- | | | | |
|---|---|----|--------------------|
| 1 | KFGS unit | 6 | Lubrication lines |
| 2 | Power supply | 7 | Piston detector |
| 3 | Fault indicator light | 8 | Master feeder |
| 4 | Fill level switch | 9 | Secondary feeder |
| 5 | Pump element with pressure regulating valve | 10 | Lubrication points |

6.3 Progressive systems with KFGC (CAN bus) pump unit

The general functional description for progressive systems with a KFGS pump unit also applies for the design with CAN bus pump control.

The integrated LC-CAN 5000 control unit permits the lubrication zone of a progressive feeder system to be distributed into individual lubrication segments which can be configured with individual parameters (e.g., contact and interval times). Up to four lubrication segments can be installed in total.

To distribute the lubricant, a corresponding number of electric switch valves is installed in the lubrication line leading from the pump element. A valve is opened as soon as the control unit starts a pump cycle for the corresponding lubrication segment.

The pump can only provide adequate lubrication to one lubrication segment at a time, so it must be ensured that only one valve is opened during operation. This is handled by the control unit in automatic and semiautomatic operation.

When CAN commands are used for control, valve opening must be ensured by selecting the appropriate contact and interval times or by using appropriately programmed processes in the external lubrication program to switch

the valves in a carefully coordinated sequence so that only one valve is opened at a time.

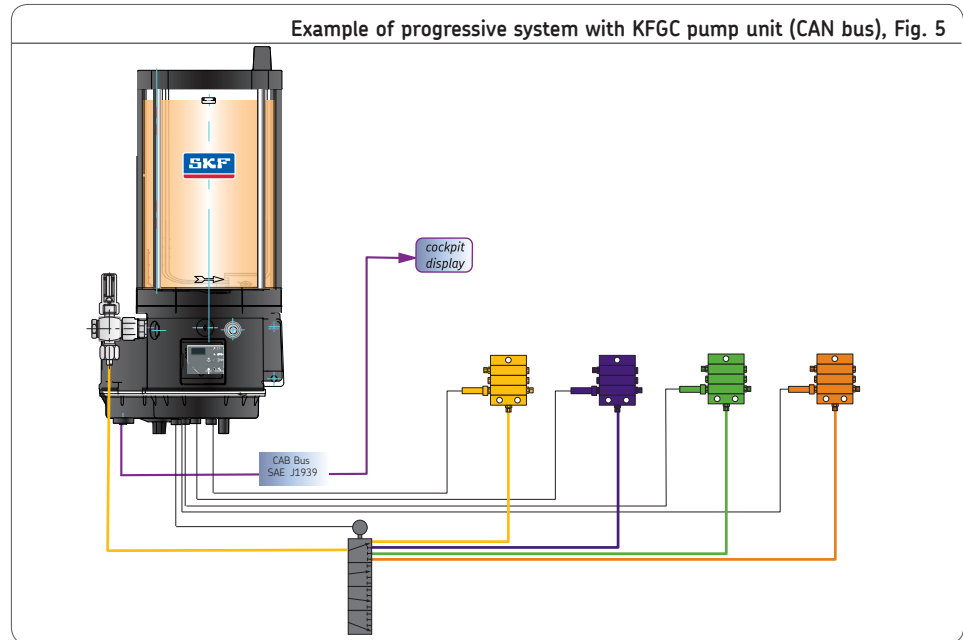

7. Functional description in single-line systems

7.1 KFG-Pump unit

A general single-line system consists of a pump unit with pump element and pressure regulating valve, pressure relief valve and fill level monitoring, main line and single-line distributors.

When the pump motor is turned on, the piston pump delivers lubricant from the reservoir to the lubricant outlet. The pump element attached to the outlet meters the lubricant and delivers it further through the pressure relief valve attached to the pump element on to the main line. The lubricant flows through the main line to the single-line distributors, where it is metered and passed to the lubrication points. This is performed during or after the pump cycle time, depending on the type of distributors used (prelubrication or relubrication distributors). The pressure relief valve switches after pressure build-up is complete. After the main line has been relieved, the pump unit is now prepared for another lubrication cycle.

7.1.1 Pump element

The pump element delivers the lubricant according to the capacity of the connected single-line distributors. There are both prelubrication distributors and relubrication distributors.

7.1.2 Pressure relief valve

In order to allow another lubrication cycle after metering is complete, the main line must first be relieved of pressure, which also relieves the downstream single-line distributors. The main line and single-line distributors relieve into the lubricant reservoir.

7.1.3 Pressure regulating valve

A pressure regulating valve can be installed single-line systems to prevent excessive operating pressure in the lubrication system. The pressure regulating valve (see Technical Data, Chapter 4.3.5 in the assembly instructions) opens when operating pressure exceeds its cracking pressure. The lubricant escapes through the valve or flows back into the reservoir. This protects the pump unit against overload.

Pressure relief valve/pressure regulating valve,
Fig. 6



Example of single-line system with KFG pump unit, Fig. 7

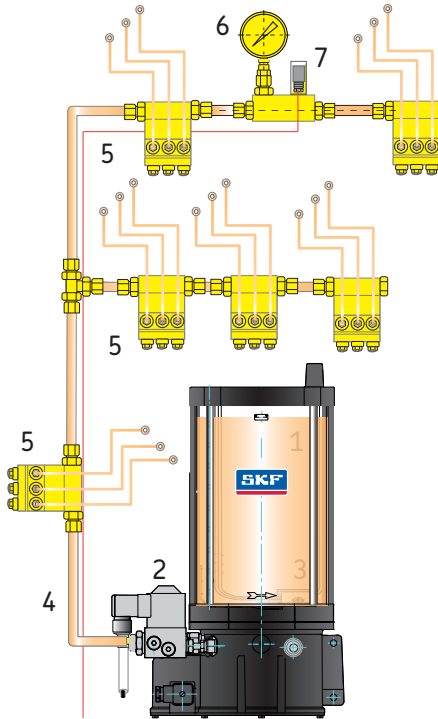

Single-line system with KFG pump unit

- 1 KFG unit
- 2 Pump element with pressure relief valve with integrated pressure regulating valve
- 3 Fill level switch
- 4 Main line
- 5 Single-line distributor
- 6 Pressure gauge for pressure build-up monitoring
- 7 Pressure switch for pressure build-up monitoring

7.2 Functional description: (single-line systems) with KFGL-Pump unit

The general functional description for single-line systems with a KFG pump unit also applies for the design with KFGL pump control.

The LC502 control unit integrated into the pump housing allows the following additional configuration, monitoring and connectivity options:

- Interval time and contact time can be adjusted independently for pressure-monitored and pressure-controlled systems
- Adjustment of setting times and parameters on a full dot display
- Recording of remaining intervals and remaining lubrication times
- Multizone systems possible
- Extensive fault monitoring/diagnosis
- Recording of fault notifications (diagnostics memory)
- Data backup in case of voltage failure
- Non-volatile memory with PIN code protection
- Connectivity for pressure switch
- Fill level monitoring, lubrication cycle stop and fault notification remain on display in case the level falls below minimum.

Example of single-line system with KFGL pump unit, Fig. 8

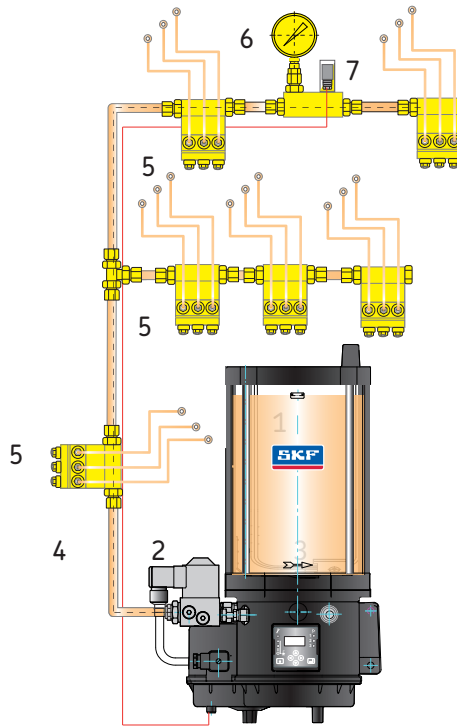

Legend to figure of KFGL single-line system

- 1 Unit with pump element, LC 502 control unit
- 2 Pump element with pressure relief valve with integrated pressure regulating valve
- 3 Fill level switch
- 4 Main line
- 5 Single-line distributor
- 6 Pressure gauge for pressure build-up monitoring
- 7 Pressure switch for pressure build-up monitoring

7.3 Functional description in single-line systems with a KFGC (CAN-Bus) pump unit

The general functional description for single-line systems with a KFGC pump unit also applies for the design with CAN bus pump control.

7.3.1 Systems with 3/2 directional solenoid valves

Directional solenoid valves can be used to create a single-line system with up to four lubrication zones. The system can be equipped with or without functionality to monitor pressure build-up and reduction.

7.3.2 Multiple lubrication zones

Using the integrated LC-CAN 5000 control unit, a single-line system can be divided into up to four individually controllable lubrication zones. This is performed using electric switch valves which separate the individual lubrication zones from each other. Four configurable digital inputs/outputs are available to control each lubrication zone. This, as well as the type of valves used, provides various possibilities for setting up lubrication zones.

Example of single-line system with KFGC pump unit, Fig. 9

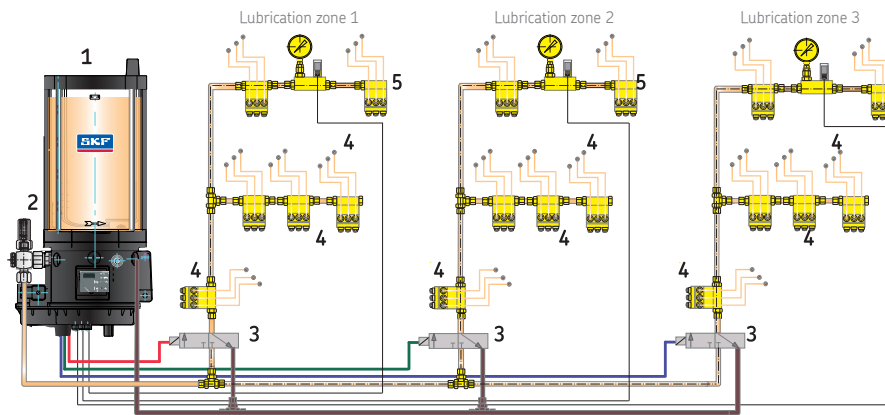

Legend

- 1 Pump unit with pump element and fill level monitoring
 - 2 Pressure regulating valve
- Lubrication zone 1/2/3**
- 3 Valve for pressure build-up and relief
 - 4 Single-line distributor
 - 5 Pressure switch for pressure build-up monitoring

8. Commissioning

The reservoir unit described here functions automatically. The lubricant transport in the lubrication lines should, however, be subjected to regular visual inspection.

The lubricant fill level in the lubricant reservoir, if present, should likewise be subjected to regular visual inspection. If the lubricant fill level is too low, lubricant needs to be added up to the maximum mark as described in Chapter 4.4.1.



Observe the instructions from the machine manufacturer regarding the lubricants that are to be used.



Warning!

Only fill using clean lubricant and an appropriate device. Contaminated lubricants can result in severe system malfunction. The lubricant reservoir must be filled without introducing bubbles.



Warning!

Different lubricants cannot be mixed, as mixing may result in damage and necessitate costly and complicated cleaning of the product/centralized lubrication system.

It is recommended that an indication of the lubricant in use be attached to the lubricant reservoir in order to prevent accidental mixing of lubricants.

8.1 General commissioning

Before the product is commissioned, all electrical connections must be inspected.

The lubricant may only be fed without bubbles. The lubricant reservoir, if present, must be filled with clean lubricant without introducing bubbles. The product is then operated until lubricant without bubbles is discharged at all lubrication points.

The process of venting the centralized lubrication system can be facilitated by:

- Opening the ends of the main pipes until lubricant without bubbles is discharged.
- Filling long pipe sections before connecting to the lubrication points.

9. KFGS control unit

9.1 Display and control elements of control screen

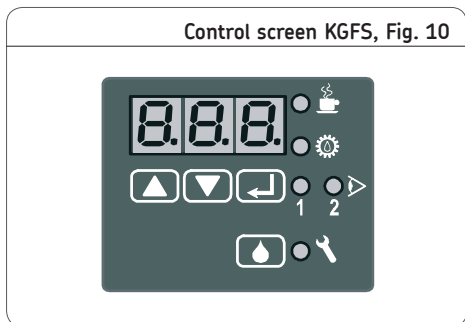

The display and control unit is protected from water splashes and mechanical damage by a transparent plastic cover. The cover must be removed to program the unit and then re-mounted afterwards.



Display and control elements of the KFGS control screen

Symbol	Description	Function
	Three-digit LED display	Values and operating status
	PAUSE LED	Interval time
	CONTACT LED	Display contact time (pump operation)
	1 = CS LED	Monitors system function via an external piston detector CS = Cycle Switch, piston detector
	2 = PS LED	PS = pressure build-up monitoring on progressive systems
	FAULT LED	Fault notification
	UP or DOWN key	<ul style="list-style-type: none"> ○ Switch on display ○ Display values and parameters ○ Set values and parameters
	SET key	<ul style="list-style-type: none"> ○ Switch between programming mode and display mode ○ Confirm values
	DK key	<ul style="list-style-type: none"> ○ Trigger interim lubrication ○ Delete fault notification

9.1.1 Three-digit LED display

The display is off in normal mode. It can be activated by briefly pressing one of the two pushbuttons  . Current values and pre-set parameters are displayed. The display also serves to guide and prompt the operator while programming operating parameters.

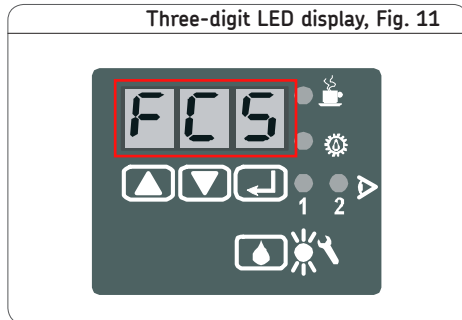

Three-digit LED display			
Display	Meaning	Statement	Control function
t PA	t = TIMER PA = PAUSE	The control unit is functioning as a timer and is currently in PAUSE mode.	Part of lubrication cycle; entry and display value in hours.
c PA	c = COUNTER PA = PAUSE	The control unit is functioning as a counter and is currently in PAUSE mode.	Part of the lubrication cycle; the device counts the pulses from the external timer and compares them with the pre-set values.
t CO	t = TIMER CO = CONTACT	The control unit is functioning as a timer and is currently in a pump cycle (CONTACT).	CONTACT = time during which the pump delivers lubricant; entry and display value in minutes.
c CO	c = COUNTER CO = CONTACT	The control unit is functioning as a counter and is currently in a pump cycle (CONTACT).	CONTACT = time during which the pump delivers lubricant; entry and display value in pulses.
COP	C = Cycle O = OFF P = Pressure	Display the "Monitoring settings" menu	
OFF	Monitoring OFF	The CS and PS monitoring functions are switched off.	No system monitoring
CS	Cycle Switch Piston detector (progressive systems)	Piston detector monitoring is active.	The piston detector is monitored for signals during the CONTACT pump cycle.

Three-digit LED display, Fig. 12



Continuation of "Three-digit LED display" table

Display	Meaning	Statement	Control function
PS	Pressure Switch Pressure switch (single-line systems)	Pressure switch monitoring is active.	The system pressure is monitored by the pressure switch during the pump cycle
FLL	Low Level Fault: fill level too low.	The minimum fill level has been reached in the reservoir.	
FCS	Fault Cycle Switch Fault: Piston detector	No signal from piston detector during pump cycle.	The control unit is currently in FAULT mode. The operational sequence has been stopped.
FPS	Fault Pressure Switch Fault: Pressure switch	No signal from the pressure switch during pump cycle.	The control unit is currently in FAULT mode. The operational sequence has been stopped.
Oh	Operation Hour Meter Operational hours counter	The values shown after this are the number of hours the control unit has operated.	The control unit is currently in FAULT mode. The operational sequence has been stopped.
Fh	Fault Hour Meter Fault-hours counter	The values shown after this are the number of fault hours, i.e., the amount of time the vehicle or machine was operated in FAULT mode.	
blo	Block mode	No signal from the piston detector. Unlike in normal mode, the control unit is still the monitoring sequence. A fault notification is issued if the fault remains for three pump cycles times.	

9.1.2 LED display

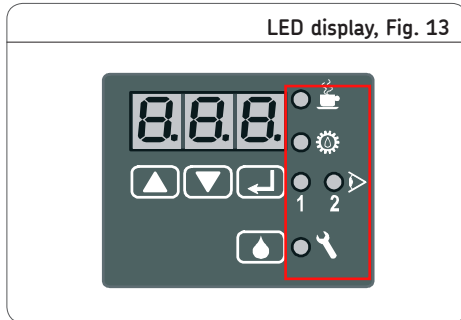

LED display



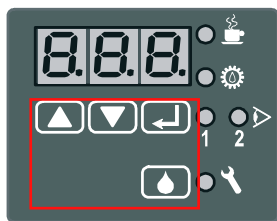

LED	LED lights up = display mode	LED flashes = programming mode
	Operating voltage is present on pump unit and control unit, system is currently in operating status PAUSE	Value for PAUSE can be changed.
	Operating voltage is present on pump unit and control unit, system is currently in operating status CONTACT (pump motor ON)	Value for CONTACT can be changed.
CS	A cycle switch (CS) is used for system monitoring. On progressive feeders, monitoring is performed during the pump cycle (CONTACT). 1 The LED lights up when a signal is received.	Monitoring type can be switched off in programming mode. COP = CS monitoring is active COP = OFF monitoring is switched off
PS	2 System monitoring using pressure switch (PS)	
	The operating voltage is present on the pump unit and control unit. The control unit is in operating status FAULT. The cause can be accessed via the LED display and shown as a fault code by pressing the pushbutton. The operational sequence has been stopped.	

9.1.3 Pushbutton operation

Pushbutton, Fig.14





Pushbutton operation

Key	Function
	Pressing during PAUSE triggers an interim lubrication. Fault notifications are acknowledged and deleted.
	Switch on the display in display mode Call up next parameter in programming mode Increase displayed value by 1
	Switch on the display in display mode, call up last parameter in programming mode, reduce displayed value by 1.
	Switch between programming mode and display mode Confirm values entered









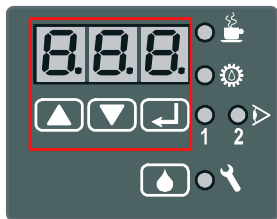





9.2 KFGS display mode

Display mode can be identified by the lit-up LED displays. The display does not flash. It is used to query the current settings and operating parameters.

Always start the display mode by briefly pressing one of the two keys  .

Display mode, Fig. 15



			Display mode
Step	Key	Display	
1	  press briefly		The current operating status is shown Example: Pause Timer operation
2			Display remaining interval time for current lubrication cycle. Example: 1 h
3			Display pre-set total interval time Example: 2.6 h (factory setting) Note! Display is in hours
4			Display pump cycle time Example: Timer operation
5			Example: System is currently in operating status Pause, current tCO display (timer COntact) not possible
6			Display of the pre-set value Example: 4 min (factory setting) Note! Display is in minutes
7			Display system monitoring

Continuation of "Display mode" table

Step	Key	Display	
8		 or  or 	Monitoring switched off (factory setting) Monitoring via Piston detector (On progressive systems not admissible!)
9			Display operating hours
10/11		 + 	Example: 1st part of total value Write down. 2nd part of total value Total value: 00533.8 h Maximum value: 99999.9 h
12			Display fault hours
13/14		 + 	Example: 1st part of total value Write down. 2nd part of total value Total value: 00033.8 h Maximum value: 99999.9 h
			Display clears Oh and Fh values are stored in EEPROM and cannot be deleted.

9.3 KFGS programming



The working/interval times can be reprogrammed to adapt the lubrication intervals and the resulting lubricant quantities to specific requirements.

9.3.1 Start programming mode













 Programming mode can be identified by the flashing LED displays.

9.3.2 Change lubrication interval times





Note on step 2

If the 000 factory setting has been changed, the changed code must be selected using the   keys and confirmed using the  key.

Change lubrication interval times

Step	Key	Display	
1	 Press for more than 2 s		Display flashes (000 factory setting)
2	 Press briefly (confirm code)		Automatic display of first parameter: "pause in timer operation" "PAUSE" LED flashes
3	 Press briefly		Interval time 1 h (factory setting) (display in hours)
4	 		Set new value Example: 6.8 h = 6 h 48 min
5	 Press briefly (confirm new value)		Display parameter: "Pump cycle time Timer operation" "CONTACT" LED flashes
6	 Press briefly		Pump cycle time 4.0 (factory setting) For the permissible setting range for KFG(S) 90-264 VAC -see Technical Data, Chapter 13 (display in minutes)













Continuation of "Change lubrication interval times" table

Step	Key	Display	
7			Set new value Example: 3 min
8	 Press briefly (confirm new value)		
9	 Press for more than 2 s		Changes are written to memory, the values are activated, and the display clears

9.3.3 Configure system monitoring













System monitoring can be changed to activate or deactivate the monitoring functions for lubrication.

When system monitoring is active, you can select monitoring via piston detector or monitoring via pressure switch.

Configure system monitoring			
Step	Key	Display	
1	 Press for more than 2 s		Display flashes (000 factory setting)
2	 Press briefly (confirm code)		Automatic display of first parameter: "pause in timer operation" "PAUSE" LED flashes
3	 Press until:		Beginning of monitoring settings is displayed
4	 Press briefly		System monitoring switched off (factory setting)
5	 Press either until	 Monitoring via piston detector LED "PS" flashes	 (On progressive systems not admissible!)
6	 Press briefly		Confirm new setting
7	 Press for more than 2 s		New settings are written to memory, the values are activated, and the display clears

9.3.4 Change operating modes

A change of operation mode means changing to timer operation, counter operation or special applications.

Change operating mode			
Step	Key	Display	
1	 Press for more than 2 s		Display flashes (000 = factory setting)
2	 Press briefly (confirm code)		Automatic display of first parameter: "pause in timer operation" "PAUSE" LED flashes
3			Change from interval time to counter operation (only possible with external electrical pulse generator) Values in pulses
4	 Press briefly to confirm counter operation		Display pump cycle time in timer operation
5			Change from pump cycle time to counter operation, special application
6	 Press briefly		Confirm new setting
7	 Press for more than 2 s		New settings are written to memory and the display clears

9.3.5 Change access code

















Note!!

This factory default code is now deleted and the new value is activated. Write down the new value and store it in a safe place. The parameters cannot be programmed if the code is lost or forgotten. In this case, the pump unit must be sent to the dealer or authorized SKF branch office.



Warning!

Do not enter the digits 321 as the new code.

Change code			
Step	Key	Display	
1	 Press for more than 2 s		Display flashes (000 = factory setting)
2	  Press briefly		key number is selected (321 = factory default setting)
3	 Press briefly (confirm key)		Display flashes (000 = factory setting)
4	 Press briefly (confirm code)		Display flashes
5	  Press either until		new code is set Example: 666 Warning! Do not enter 321.
6	 Press briefly		Confirm new code
7	 Press for more than 2 s		New code is written to memory and the display clears

9.3.6 Programming ranges

Programming ranges	
Function	Programming range ¹⁾
Interval time	0.1 h to 99.9 h
Pump cycle time	0.1 min to 99.9 min
Pulses	1 to 999

1) For the permissible setting range for KFG(S) 90-264 VAC, see Technical Data, Chapter 13.

9.3.7 Display ranges

Display ranges	
Function	Display range
Fault hours	0.1 h to 99999.9 h
Operating hours	0.1 h to 99999.9 h

9.4 KFGS operating modes

9.4.1 Timer operation

The interval and pump cycle are time-dependent.

The lubrication cycle is controlled by the pre-set, time-dependent values for PAUSE and CONTACT.

PAUSE: Values in hours

CONTACT: Values in minutes



Set **tPA** and **tCO** in programming mode.

9.4.2 Counter operation

The interval depends on the number of pulses; the pump cycle time is time-dependent.

An external pulse generator must be attached as described in Chapter 4 in the assembly instructions.

PAUSE: Values in pulses

CONTACT: Values in minutes

A switch opens and closes based on machine movements, revolutions, etc.

A lubrication is triggered once the set number of pulses (**cPA**) is reached.



Set **cPA** and **tCO** in programming mode.

9.4.3 No system monitoring

In this operating mode, the lubrication cycle is controlled solely by the pre-set values for PAUSE and CONTACT.

- ! Monitoring must be switched off.
COP = OFF System malfunctions are not automatically detected or displayed.

9.4.4 With system monitoring

In this operating mode, system functions are additionally monitored using external switches. The following can be monitored:

- Fill level in the lubricant reservoir
- Function of progressive feeder using a piston detector

- ! Operational malfunctions are automatically detected and displayed. Monitoring is switched on.
COP = CS or **COP = PS**

9.5 Fill level monitoring

- ! If fill level monitoring is installed, it is always active.

If the level in the lubricant reservoir falls below the minimum fill level, the lubricant cycle is stopped and a fault notification is issued on the display.

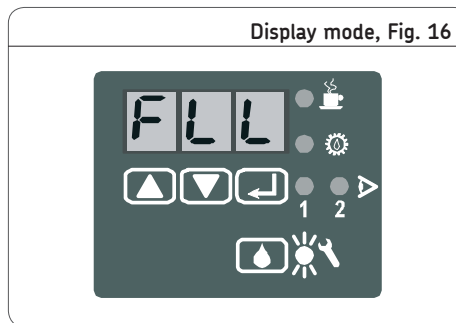

- ! A unit can only be retrofitted from "without" fill level monitoring to "with" fill level monitoring in the factory, which requires that it be sent to the factory for rework.

9.5.1 Monitoring via piston detector

- ! **Only possible for centralized lubrication systems with progressive feeders.**

For greases up to NLGI Grade 2.

The piston detector monitors the movement of pistons in the progressive feeder during CONTACT time (pump cycle time). The following monitoring setting must be activated in programming mode:

COP = CS (see Chapter 9.3.3).

Monitoring via piston detector, Fig. 17

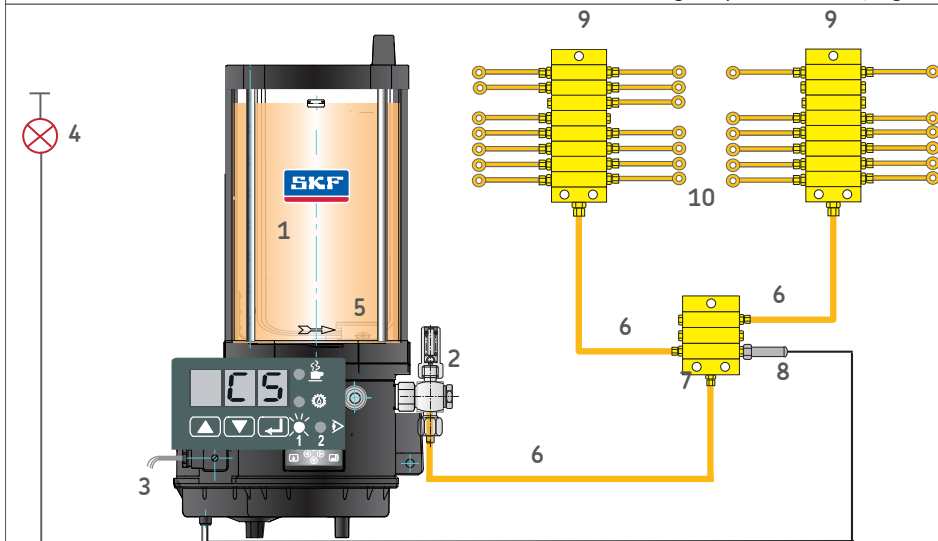

Progressive system with piston detector

- | | | |
|---|-------------------------|-----------------------|
| 1 KFGS unit | 4 Fault indicator light | 8 Piston detector |
| 2 Pump element with pressure regulating valve | 5 Fill level switch | 9 Secondary feeder |
| 3 Power supply | 6 Main lines | 10 Lubrication points |
| | 7 Master feeder | |





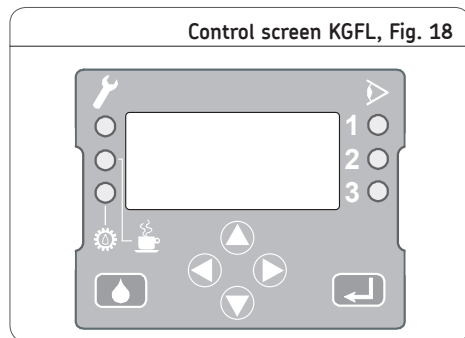

10. KFGL control unit

10.1 Display and control elements of control screen





The display and control unit is protected from water splashes and mechanical damage by a transparent plastic cover. The cover must be removed to program the unit and then re-mounted afterwards.



Display and control elements of control screen

Symbol	Description	Function
	Display	<ul style="list-style-type: none"> ○ Menu display ○ Display of values and parameters ○ Fault notification
	FAULT LED	Display fault notification <ul style="list-style-type: none"> ○ Red LED flashes = error detected ○ Red LED lights up = fault on a signal input, no error detected on pump control unit (error is outside pump)
	PAUSE LED	Display pause time <ul style="list-style-type: none"> Yellow LED lights up = active pump pause time on at least one main line
	CONTACT LED	Display contact time (pump operation) <ul style="list-style-type: none"> Green LED lights up = active pump run time
	1 = Output 1 2 = Output 2	Display pump output 1 to 2 <ul style="list-style-type: none"> ○ LED on output 1 or 2 lights up = pump output 1 or 2 is switched on. Lubricant is delivered via the indicated line (1 or 2)
	3 = Inputs	Display all signal inputs <ul style="list-style-type: none"> ○ LED lights up = signal change on input port The LED lights up for approx. 1 second each time the signal on the input port changes.
	ENTER key	<ul style="list-style-type: none"> ○ Confirm value ○ Confirm input and values

Display and control elements of control screen

Symbol	Description	Function
	Operator keys	Operator keys ○ for menu selection (navigation) ○ for editing numerical values
	Operator keys	Operator keys for menu selection (navigation) (arrow key up/down/left) Go to the selected menu based on direction of arrow
		Operator keys for editing numerical values (arrow key up/down) ○ The numerical value is incremented/decremented based on direction of arrow. Press <arrow key right> or <arrow key left> to move the cursor position to the adjacent digit. To exit the editor window without saving the current change, press the key again after reaching the last digit. Pressing <arrow key up> increments the selected digit by one. Pressing <arrow key down> decrements the selected digit by one. The input value for seconds and minutes can be between 0 and 59; a value between 0 and 65535 can be programmed for hours.
		Operator key for editing numerical values (arrow key right) ○ Pressing the key moves the cursor one position to the right. If the cursor is on the right edge, the edit window closes and the changes are discarded.
	DK key	○ Pressing triggers an interim lubrication. ○ Fault notifications are acknowledged and deleted. ○ Actuations while in configuration mode are ignored.

10.2 Display and control menu

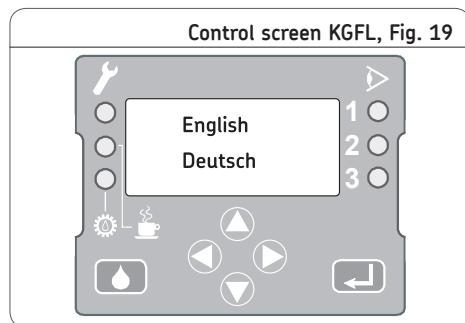

The control unit's display has three rows of eight characters each. Only three options are shown in menu windows containing more than three available choices. Press the <up/down> arrow keys to access further options.

Configuring a setting on the device involves consecutively opening multiple menu windows. The current device setting is then shown on a black background.

Not all possible options are displayed in the settings. Only settings that are available and permitted for the selected device type (ProFlex or MonoFlex) and the current device settings are shown.

The first menu level shows language selection. The language that is currently selected flashes. Upon confirmation, the main menu will be displayed in the selected language.

10.2.1 Main menu

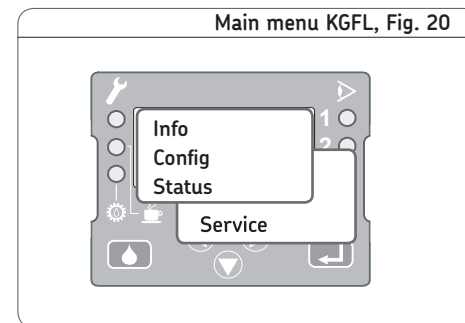

The main menu shows the following options:



- Device-specific information
- Device configuration
- Status information



Note!

The Service menu selection is password-protected and can only be accessed by SKF employees.

Base and main menu

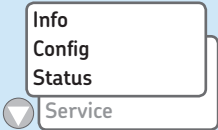
Step	Key	Display	Description
1			Entry mask/language selection The German version is active by default (flashing) Press the “up” arrow key to change to the English version Press the Enter key to confirm.
2			Main menu

Main menu items

Display	Description
Info	Display device-specific data such as serial number or firmware
Config.uration	Parameter settings
Status	Display current status of control unit
Service	Service menu Menu level only enabled for SKF service personnel

10.2.2 Info - Information mode

Information mode is used to query the hardware identification code and the runtimes stored thus far for the system, motor, and error time (system runtime, motor runtime, error time).

Note!







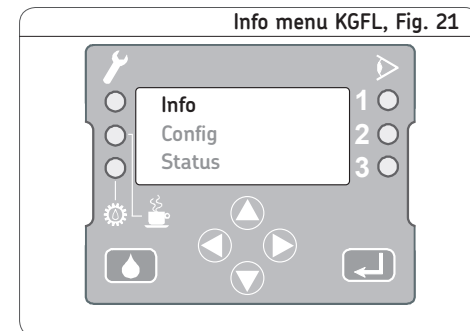



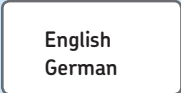

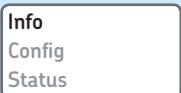
No values can be entered or modified in information mode.

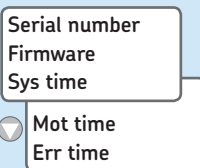
- Selection in information mode is performed by briefly pressing one of the -keys.

Info menu KGFL, Fig. 21

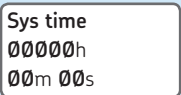
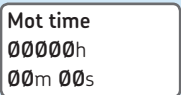
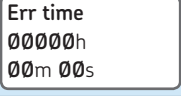

Information mode

Step	Key	Display	Description
1			Entry mask/language selection The German version is active by default (flashing). Press the "up" arrow key to change to the English version. ● Press the ENTER key
2			Main menu Press the ENTER key to go to the Info menu.
3	 		Info menu  You can switch between menu items using <arrow key up> and <arrow key down>.  Press the ENTER key to go to the selected menu. ● Press the ENTER key
4	   	  	Serial number Each control unit has an assigned serial number that can be viewed by pressing the ENTER key. Firmware This is the current version number of the software and can be viewed by pressing the ENTER key. Sys time This displays the total running time (on-time) of the control unit in hours, minutes, and seconds. Mot time This displays the total runtime of the pump motor in hours, minutes, and seconds. Err time This displays the total time of the current error (if present). If there is currently no error state, the display shows the sum time of all errors detected thus far.  Press the <<arrow key left> to return to the main menu. ● <Press <arrow key left>

10.2.3 Config. - Configuration mode

Configuration mode is started by selecting <Config.> in the main menu and pressing the ENTER key. First you need to specify whether you want to edit the configuration data or view it only. If you want to edit the configuration data, a password is requested.











Note!

When the correct password is entered, all currently running lubrication procedures are stopped and the configuration mode starts.







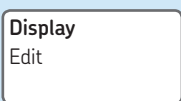

If the configuration data will be viewed and not modified, the <Config. menu> will appear upon confirmation by pressing the ENTER key. No changes can be made in this mode.

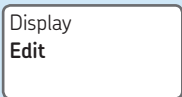
- Selection in configuration mode is performed by briefly pressing one of the  keys.

Configuration menu, table 1 of 2

Step	Key	Display	Description
1			Entry mask/language selection The German version is active by default (flashing). Press the "up" arrow key to change to the English version. ● Press the ENTER key
2	 		Main menu ● Use the arrow key to select "Config." ☞ Press the ENTER key to go to the Config. menu.
3	   		Config. menu Display Press the ENTER key to go to the Configuration menus. Here you can view the configurations for: ○ System ○ Settings ○ Inputs ○ Outputs The active configuration or selection will flash. Data cannot be entered or changed in display mode.

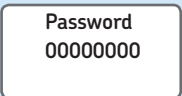
Configuration menu, table 2 of 2

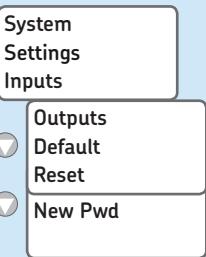
Step	Key	Display	Description
4			Edit ☞ Press the ENTER key to go to the password prompt menu. ● Press the ENTER key
5	    		Password menu ☞ The following request for a password prevents changes being made by unauthorized persons. ● Press <arrow key up> to increment the number by 1, up to 9. ● Press <arrow key down> to decrement the number by 1, up to 0. ● Press <arrow key right> to move to the next password number (max. 7) ● Press the ENTER key ☞ Pressing the ENTER key gives access to the following configuration menus or: ● Press „ <<arrow key left> to return to the main menu.
6	 		Configuration sub-menu selection ☞ Press the ENTER key to go to the Config. menu.

10.3 Programming a KFGL pump unit

Detailed, separate operating instructions for the IC502 control unit are supplied together with these assembly instructions.

Chapter 5 of these operating instructions lists the adjustment options available to the customer.

Document no. 951-180-004-EN

For the programming of a KFGL pump unit in MonoFlex design (single-line centralized lubrication system)

Document no. 951-180-005-EN

For the programming of a KFGL pump unit in ProFlex design (progressive centralized lubrication system)

The operating instructions should be used when programming the IC502 control unit of the KFGL pump unit.



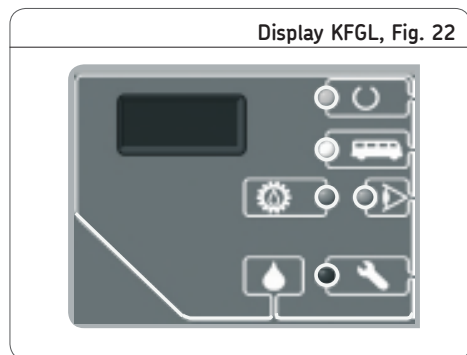

11. KFGC control unit

11.1 KFGC series (CAN bus)

The display and control screen is protected from water splashes and mechanical damage by a transparent plastic cover. The cover must be removed to operate the unit and then remounted afterwards.

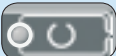

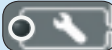

Display and control elements of the KFGC control screen

Symbol	LED color	Description	Function
	Green	POWER LED	Lights up when operating voltage present.
	Blue	Pump LED	Lights up when pump is running.
	White	BUS LED	Lights up when communication with the CAN network has been successfully established.
	Yellow	CS/MC LED	Lights up briefly when the control unit detects a signal edge at an input from a piston detector (CS), pressure switch (PS) or from the machine contact (MC).
	Red	FAULT LED	<p>LED lights up: Indicates a fault that does not immediately influence the lubrication program (e.g., break in valve cable). The lubrication program continues despite the fault notification.</p> <p>LED flashes: LED lights up: Indicates a fault that influences the lubrication program (e.g., break in piston detector cable). The lubrication program is aborted.</p>

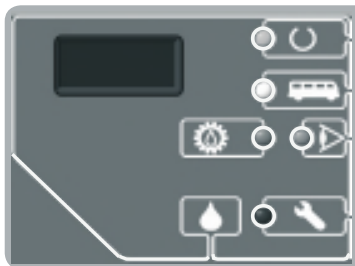
Display KFGL, Fig. 23



Continuation of "Display and control elements of the KFGC control screen" table

Symbol	Description	Function
	IrDA interface	Infrared service interface ○ Read stored status data and fault notifications ○ Configure the control unit via PC
	DK key	○ Trigger interim lubrication ○ Delete fault notification ○ Halt lubrication

12. Shutdown/disposing

12.1 Temporary shutdown

The described product can be temporarily shut down by disconnecting the electrical supply connections. The instructions in the Chapter "General information" in these assembly instructions must be observed when doing so.

If the product is to be shut down for an extended period of time, follow the instructions in the Chapter "Transport, delivery, and storage" of these operating instructions.

To recommission the product, follow the instructions in the Chapter "Assembly."

12.2 Permanent shutdown

If the product will be permanently shut down, the local regulations and laws regarding the disposal of contaminated equipment must be observed.



Warning!



Lubricants can contaminate soil and bodies of water. Lubricants must be properly used and disposed of. Observe the local regulations and laws regarding the disposal of lubricants.

The product can also be returned to SKF Lubrication Systems Germany AG for disposal, in which case the customer is responsible for reimbursing the costs incurred.

The parts are recyclable.

13. Maintenance and service



Danger!

Work on products that have not been de-energized may result in bodily injury. Assembly, maintenance and repair work may only be performed on products that have been de-energized by qualified technical personnel. Supply voltage must be switched off before opening any of the product's components.



Danger!

Centralized lubrication systems are pressurized during operation. Centralized lubrication systems must therefore be depressurized before starting assembly, maintenance or repair work, or any system modifications or system repairs.



Danger!

The described product is pressurized during operation. The product must therefore be depressurized before starting assembly, maintenance or repair work, or any system modifications or system repairs.

SKF Lubrication Systems Germany AG products are low-maintenance. However, all connections and fittings must be regularly inspected for proper seating to ensure proper function and to prevent hazards from arising.

If necessary, the product can be cleaned using mild cleaning agents that are compatible with the product's materials (non-alkaline, non-soap). For safety reasons, the product should be disconnected from the power supply and the hydraulic and/or compressed air supply.

Do not allow any cleaning agent to enter the interior of the product during cleaning.

It is not necessary to clean the interior of the product if the product is operated normally and intercompatible lubricants are used.

The interior of the product must be cleaned if incorrect or contaminated lubricant is accidentally filled into the product. If this occurs, please contact the Service department of SKF Lubrication Systems for assistance.



Dismantling of the product or individual parts thereof within the statutory warranty period is not permitted and voids any claims.



Only original spare parts from SKF Lubrication Systems Germany AG may be used. Unauthorized alterations to products and the use of non-original spare parts and accessories are prohibited and nullify the statutory warranty.

SKF Lubrication Systems Germany AG shall not be held liable for damages resulting from improperly performed assembly, maintenance or repair work on the products.

13.1 General information

The following maintenance table contains an overview of the inspections and maintenance work that must be performed on a regular basis.

The maintenance intervals depend on customer-specific settings and operating conditions. The customer is therefore responsible for determining and observing the maintenance intervals on its own.



All work beyond this scope must be performed by authorized SKF Service establishments.



The purity of the lubricants used is the decisive factor in the service life of the pump elements.

13.2 Maintenance and repair

The following maintenance and repair work must be performed on a regular basis:

- Check of fill level in lubricant reservoir
- Regularly inspect system components for leaks
- Visually inspect lubrication of bearings
- Inspect electrical cables for damage
- Inspect electrical connections and contacts
- The basic function of the control unit and system components can be inspected by triggering an interim lubrication
- Inspect electrical connections in case of malfunction notifications
- Replace defective fuses with new fuses of the same performance and characteristics

13.3 Service

If you encounter problems or have any questions, please contact our sales and service centers or our representatives abroad.

A list with current addresses is available on the Internet at:

www.skf.com/lubrication

Maintenance work

Maintenance work	Action	Interval
KFG; KFGS; KFGL; KFGC		
Check of fill level in lubricant reservoir	Refill if necessary.	Depends on planned lubricant consumption
Inspection of system components (lubricant lines, connection points, seals, etc.) for leaks.	Parts that exhibit leaks must be replaced. Please contact an SKF service office	After each refill of the lubricant reservoir or after long operational pauses before commissioning the system
Visual inspection of bearings' lubrication	In case of insufficient bearing lubrication, a fault in the lubrication system or incorrect system configuration is the probable cause. Observe the instructions contained in these operating instructions. If necessary, please contact an SKF service office.	In conjunction with lubrication reservoir filling.
KFGS; KFGL; KFGC		
Check of basic function of control unit and system components	To inspect the basic functions, trigger an interim lubrication by pressing the  key or send the corresponding CAN command.	After each lubrication reservoir filling
Inspection of electrical cables for damage	Damaged cables must be replaced. Please contact an SKF service office	After long operational pauses before commissioning the machine/vehicle
Inspection of electrical connections and contacts for firm attachment and corrosion	Tighten loose contacts. Clean any corroded electrical contacts with a wire brush, then apply a small amount of contact grease after installation	Whenever maintenance is performed, and at least once every six months

14. Operational and pump faults

14.1 Operational malfunctions

14.1.1 General information

The operator/operating personnel must perform visual fill level control of the lubricant reservoir at regular intervals. The control intervals depend on the amount of lubricant required and the pump's run time. The operator/operating personnel must therefore determine the intervals on their own based on the specific conditions of usage.



If the reservoir has been emptied, the entire system must be ventilated after refilling (see Chapter 6, Assembly).

14.1.2 Malfunctions on pump units

Pump malfunctions

Fault	Possible cause	Rectification
Pump Agitator in grease reservoir does not rotate during the activated pump cycle time	<ul style="list-style-type: none"> ○ Mechanical damage, e.g., motor defective. ○ Low voltage ○ Electrical connection interrupted 	<ul style="list-style-type: none"> • Replace pump. <ul style="list-style-type: none"> - Loosen main line at outlet of pressure regulating valve - Loosen electrical connection. - Loosen three fastening screws. - Remove defective pump. - Mount new pump and connect lubrication line and electrical cable. • Perform commissioning and functional inspection. • Be sure the interval and contact times are correct. • Check or replace fuse. • Check electrical connections. • Check cable set for damage.

Pump malfunctions



Fault	Possible cause	Rectification
<p>Pump does not function when the  key is pressed, although all electrical connections are ok.</p>	<ul style="list-style-type: none"> ○ Electrical control has failed. ○ Pump drive/motor is defective. ○ Lubricant level in reservoir is below minimum ○ Agitator cannot be rotated. 	<ul style="list-style-type: none"> • Check fuse. • Replace pump. • Fill lubricant reservoir to "max." • Replace pump element Note: metering is indicated by grooves or letters
<p>Pump does not deliver any lubricant, although agitator is rotating.</p>	<ul style="list-style-type: none"> ○ Suction problems due to air pockets in grease ○ Pump element does not build up pressure, pump element is worn out. (This is indicated when the outlet can be closed with a finger once the main line is removed.) ○ Lubricant too stiff 	<ul style="list-style-type: none"> • Dismantle pump element and operate pump using  key until grease discharges from outlet on housing. • Replace pump element Note: metering is indicated by grooves. • If necessary, adjust lubricant to work properly at lowest working temperature.
<p>Pressure regulating valve on pump opens and lubricant leaks out</p>	<ul style="list-style-type: none"> ○ System pressure is over 200/300 bar, e.g., due to feeder blockage or blocked lubrication point. ○ Valve is damaged or contaminated, so it does not close properly. 	<ul style="list-style-type: none"> • Check system and repair/rework the system so the maximum system pressure at 20 °C is 200 bar. • Replace pressure regulating valve.

14.2 Malfunctions on KFGS pump unit

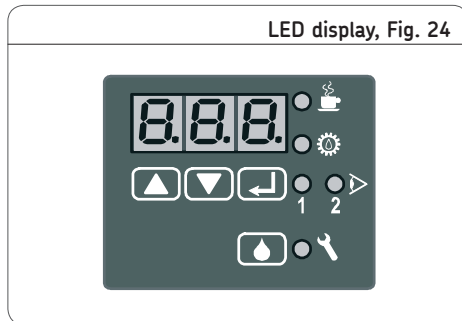
All fault notifications are displayed by the LED  as a centralized fault notification. When a fault notification is issued, the control unit stops the normal operational sequence and the fault that has occurred is saved and displayed. The cause of the fault can be read on the display. This greatly simplifies failure diagnostics, though it requires system monitoring.







14.2.1 Display faults

- Start the display mode with one of the two   keys
- Press the  key until you reach the fault notification (see following table)

Fault notification	
Display	Meaning
F C S	Fault Cycle Switch: No signal from piston detector during pump cycle. (see Chapter 9, Block Operation)
F P S	Fault Pressure Switch: No signal from the pressure switch during pump cycle.
F L L	Fault Low Level: The level in the reservoir has fallen below the minimum fill level. The further operational sequence has been stopped.



14.2.2 Delete fault notification

 All fault notifications can be acknowledged and deleted using the  key. In timer operation, this can also be performed using an external push-button, if installed.

-  **Warning!**
Determine and remedy the cause of faults before deleting fault notifications. The user is liable for damages resulting from operating the machine without lubrication.
-  The time during which the control unit and pump unit have been operated without lubrication is stored as fault hours **Fh** in the EEPROM and cannot be deleted.

14.2.3 Fault types

Depending on the severity of the fault, the control unit issues either a warning or a malfunction notification (see following table).

Fault types				
Fault type	Definition	Display	Example of fault	Response by control unit
Malfunction	<p>A fault has occurred that affects the proper functioning of the lubrication system.</p> <p>The lubrication points may not be supplied with adequate lubrication because a malfunction has affected the proper functioning of the lubrication system.</p> <p> Malfunctions must always be remedied immediately.</p>	<p> -LED lights up</p>	<p>Insufficient number of piston detector signals from a lubrication segment during the pump cycle time</p>	<p> Block operation up to configured number of repetitions</p> <p>- If the piston detector signal has still not been received, the valve is closed and a fault notification is generated.</p>

14.2.4 Recording fault times

Fault-state counter

The amount of time that passes from issuance of a failure notification to its acknowledgment is added up in hours. After acknowledgment, this value is automatically transferred to the fault-hours counter.

Fault-hours counter

The fault-hours counter adds up all fault-state times occurring during the total running time of the unit. The current counter reading can be read in display mode in two blocks of three digits each by calling up the parameter **Fh** (see Chapter 8).

The maximum reading that can be displayed is 99 999.9 hours.

The smallest recordable interval is

0.1 hours = 6 minutes. The memory cannot be deleted.

14.2.5 Malfunctions on KFGS pump unit with a progressive feeder system

Block operation

Block operation is the reaction of the control unit to the absence of signals from the piston detector.

Possible causes:

- Defective lubrication lines
- Blocked progressive feeder
- Defective piston detector
- Insufficient lubricant

No signal from piston detector during pump cycle:

- Normal operation is interrupted.
- Block pause begins with query to piston detector

No signal from piston detector during block pause:

- Second lubricating cycle begins in block operation

As soon as a signal is received from the piston detector, block operation is aborted and the normal lubricating cycle starts with a pause.



A total of three lubrication cycles are performed with query to the piston detector.

No signal from the piston detector, Fig.25

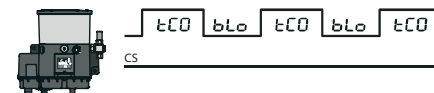

Three pump cycles and two block pauses without signal from the piston detector:

Block operation is aborted
Malfunction notification is issued.

	Duration of block pause	
Pause	tPA block pause	Normal operation blo
0.1 h = 6 min		6 min
0.2 h = 12 min		12 min
0.3 h and longer		15 min

- Determine and remedy cause of fault.

14.3 Malfunctions on KFGL pump unit

All fault notifications are displayed by the LED .

Key to LED display:

- Red LED flashes = error detected
- Red LED lights up = fault on a signal input, no error detected on pump control unit (error is outside pump)

The LC502 control unit is able to detect a range of different system faults. The control unit causes the red LED to flash when a fault is detected. In some cases the control unit switches off the affected lubrication line or all lubrication lines. An active fault is viewed as follows: In the main menu, select device status <Status> and then the fault menu. Select <Fault> in the status menu. Upon confirmation, the sources of all detected faults are displayed. A fault can be selected in the menu to view its details.

14.3.1 Display faults



Warning!

Determine and remedy the cause of faults before deleting fault notifications. The user is liable for damages resulting from operating the machine without lubrication.

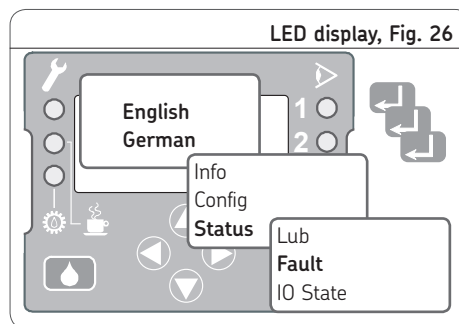

14.3.2 Delete fault notification

All fault notifications can be acknowledged and deleted using the  key; the lubrication process is then restarted in all lines. In some cases this may be able to be done with an external pushbutton (DK).

14.3.3 Fault types

14.3.4 Fault notifications

Detailed, separate operating instructions for the IC502 control unit are supplied together with these assembly instructions. Chapter 10 of these operating instructions contains the operational and pump faults for the KFGL unit.

Document no. 951-180-004-EN

Pump unit in MonoFlex design
(single-line centralized lubrication system)

Document no. 951-180-005-EN

Pump unit in ProFlex design
(progressive centralized lubrication system)

Refer to the operating instructions to remedy faults on a KFGL pump unit.

14.3 Malfunctions on KFGC pump unit

All fault notifications are displayed by the LED .

Key to LED display:

Warnings are indicated by a constant LED  light. At the same time, the fault notification is stored in the FRAM.

Malfunctions are indicated by a flashing LED  light. At the same time, the fault notification is stored in the FRAM.

- LED lights up:
Indicates a fault that does not immediately influence the lubrication program (e.g., break in valve cable). The lubrication program continues despite the fault notification.
- LED flashes:
LED lights up: Indicates a fault that influences the lubrication program (e.g., break in piston detector cable). The lubrication program is aborted.

The comprehensive monitoring functions of the LC-CAN 5000 control unit allow faults in the operational process to be detected, registered and displayed.

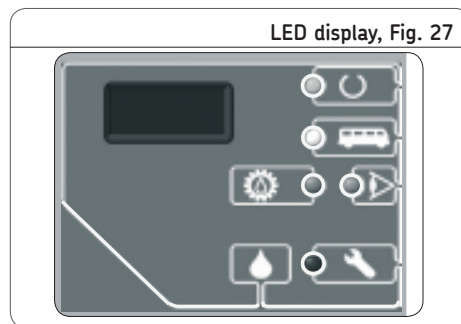

14.3.1 Faults detected by control unit

14.3.2 Fault types

14.3.3 Read faults

14.3.4 Remedy faults

For a KFGC pump unit, detailed, separate operating instructions for the LC-CAN5000 control unit are supplied together with these assembly instructions.

Chapter 10 of these operating instructions contains the operational and pump faults for the KFGC unit.

Document no. 951-130-502-EN

Pump unit with LC-CAN5000 control unit

Refer to the operating instructions to remedy faults on a KFGC pump unit.

15. Technical data

Protective measures that must be taken for operation according to the intended use in machinery:

KFG; KFGS; KFGL, KFGC... 24 VDC:

- "Functional Extra Low Voltage",
"Protective Extra Low Voltage"
(PELV)
- Disconnect the unit for insulation and voltage inspection according to EN 60204-1 1992

Continuation of "Technical Data" table

Data universally applicable to KFG, KFGS; KFGL; KFGC

Description	Key data/Display	
Conditions for electrical connections	12 VDC	24 VDC
Rated voltage		
Power consumption (load-dependent)	2.4 A ¹⁾	1.25 A ¹⁾
Power consumption (maximum)	< 5 A	< 2.5 A
Pump starting current (approx. 20 ms)	9 A	4.5 A
Max. back-up fuse	5 AT ²⁾ ³⁾	3 AT ²⁾ ³⁾
Fill level switch W1	NLGI 2 Fault notified by pulse	
Fill level switch W1G	NLGI 2 Fault notified by non-dry contact	
Fill level switch W2	NLGI ≤ 1 Fault notified by capacitive proximity switch	
Electrically controlled pressure relief valve	12/24 VDC or 230 VAC see Chapter 4.10, Page 41	
Weight with full lubricant reservoir	kg	
2 kg version	7.5	
6 kg version	13.5	
10 kg version	27.0	
15 kg version	34.5	
20 kg version	41.5	

¹⁾ Typical value at ambient temperature = 25 °C and operating pressure = 150 bar

²⁾ Fuse per DIN 72581 T:3

³⁾ Conductor: cross-section 1.5 mm²/Length ≤ 12

Continuation of Technical data

Description	Value	
	12/24 VDC	90...264 VAC
Perm. operating temperature with spring return pump elements	-25 °C to +70 °C	-25 °C to +60 °C
Perm. operating temperature with spring return pump elements	-30 °C to +70 °C	-30 °C to +60 °C
Electrical values	See Chapter 6, "General conditions for connections," page 41	
Protection class according to DIN 40050, T9	IP56	IP56
Operating mode/ON-time according to VDE0530/ DIN 41756	S1 continuous operation	
Data universally applicable to KFG, KFGS; KFGI; KFGC		
Max. back pressure	300 bar with spring return pump elements 350 bar with spring return pump elements	
Max. Number of outlets (if less than 3 outlets are required, close unneeded outlets with screw plugs)	3	
Delivery rates[cm ³ /min]	KFG1.U1 = 2.5 KFG1.U2 = 1.8 KFG1.U3 = 1.3 KFG1.U4 = 0.8 KFG1.U0 = 5.0 at max. 200 bar KFG1.U0-E at max. 250 bar	
Lubricant	NLGI Grade 1 to 2 greases with EP additives, compatible with plastics, NBR elastomers, copper and copper alloys	
Flow pressure	Up to max. 700 mbar	

Continuation of "Technical Data" table

KFGC data	
Description	Key data
Switching outputs Type Max. current-carrying capacity Modes of operation	All types Solid-state output, short-circuit-proof and overload-proof <ul style="list-style-type: none"> • with simultaneous operation of 4 outputs: 1.0 A • with simultaneous operation of 2 outputs: 1.25 A • with operation of one output: 1.5 A <ul style="list-style-type: none"> • Single operation • Parallel connection of multiple outputs while simultaneously increasing output current
Signal inputs Type Connectivity	All types digital solid-state input, short-circuit-proof <ul style="list-style-type: none"> • Switching contact, no detection of wire breakage • Dual wire sensors (e.g., piston detector), detection of wire breakage
Communication connections CAN bus Infrared	All types SAE J1939 IrDA
Electrical data Protection class Operating mode/ON-time according to VDE0530/DIN 41756	All types according to DIN 40050, T9 IP5k5 S1 continuous operation

16. Accessories

Accessories		
Description	Data	Order No.
M12x1 connector, 4-pin	with 5 m cable, 4x 0.25 mm ² , protection class IP 67 (mounted)	179-990-719
Double-pin plug (T-connector)	Double-pin plug (two-way distributor) (for connecting to the M12x1 plug on the pump with 2x M12x1 outputs for piston detector and separate indicator lamp)	179-990-700
M12x1 socket	without cable, with 4 pins, protection class IP 67 (mounted)	179-990-371
M12x1 angle plug	without cable, with 4 pins, protection class IP 67 (mounted)	179-990-372
M12x1 plug, straight	with 5 m cable, 4x 0.25 mm ² , , protection class IP 68 (mounted)	179-990-600
M12x1 angle plug	with 5 m cable, 4x 0.25 mm ² , protection class IP 68 (mounted)	179-990-601
Cable socket according to DIN 43 650	Type A (ISO 4400), pivoted, without LED, 1.5 mm ² , line diameter 6 mm to 9 mm	179-990-034
Cable socket according to DIN 43 650	Type A (ISO 4400), pivoted, without LED, 1.5 mm ² , , line diameter 4.5 mm to 7 mm	179-990-147
Cable socket according to DIN 43 650	Type A (ISO 4400), pivoted, with rectifier and yellow LED, for connected on MonoFlex Pressure relief valve, version 230 VAC.	24-1882-2167



Additional data and electrical plug-in connections are available in brochure No. 1-1730-EN, "Electric Plug-and-Socket Connectors."



The operating instructions/functional description of the corresponding control unit must be observed!

External control units

Application	Type designation Order number	Features
Piston distributor for single-line systems	EXZT2A02-E	Pulse generator/counter with adjustable interval time, interval time extension, monitoring of pressure build-up and reduction, and fill level monitoring
Piston distributor for single-line systems	EXZT2A03-E	Pulse generator/counter with selectable monitoring time, monitoring of fill level and pump cycle time (stroke monitoring), adjustable delay time, and interval time extension
Progressive systems	EXZT2A05-E	Pulse generator/counter with adjustable interval time, interval time extension, pressure build-up monitoring, pulse monitoring, and fill level monitoring
Progressive systems	EXZT2A06-E	Pulse generator/counter with selectable monitoring time, monitoring of fill level and pump cycle time (stroke monitoring), adjustable delay time, interval time extension, and pulse monitoring
Piston distributor for single-line systems	EXZT2A07-E	Pulse generator/counter with adjustable interval time, interval time extension, pressure build-up monitoring, fill level monitoring, and fill level pre-warning
Electronic timer for centralized lubrication systems	IG351-10-E	Pulse generator with adjustable interval time, adjustable pump cycle time, and fill level monitoring with NO-contact
Piston distributor for single-line systems	IGZ38-30-E	Pulse generator/counter with adjustable interval time and pressure build-up monitoring, and fill level monitoring with NC contact (wire breakage monitoring)
Piston distributor for single-line systems	IGZ36-20-E	Pulse generator/counter with adjustable interval time, monitoring of pressure build-up and reduction, and adjustable delay time
Piston distributor for single-line systems	IGZ36-20-S6-E	Same as IGZ36-20-E, but with fill level monitoring with NC contact (wire breakage monitoring)

External control units

Application	Type designation Order number	Features
Progressive systems	IGZ51-20-E	Pulse generator/counter with selectable intermittent or continuous pump operation, with adjustable stroke rate, selectable interval time and monitoring time, and monitoring of fill level and pump cycle time
Progressive systems	IGZ51-20-S2-E	Same as IGT51-20, but with non-volatile memory in case of power failure
Piston distributor for single-line systems	IGZ51-20-S3-E	Pulse generator/counter with adjustable interval time, interval time extension, monitoring of pressure build-up and reduction, adjustable delay time and connectable non-volatile memory in case of power failure
Progressive systems	IGZ51-20-S7-E	Same as IGZ51-20-S2, but with fill level switch as NC contact, pump cycle time = set monitoring time
Progressive systems	IGZ51-20-S8-E	Pulse generator/counter with selectable intermittent or continuous pump operation, prelubrication, selectable interval time and monitoring time, monitoring of fill level, pump cycle time and pulses, and non-volatile memory in case of power failure

951-170-213-EN

The contents of this publication are the copyright of the publisher and may not be reproduced in whole or in part without permission of SKF Lubrication Systems Germany AG. Every care has been taken to ensure the accuracy of the information contained in this publication. However, no liability can be accepted for any loss or damage, whether direct, indirect or consequential arising out of use of the information contained herein. All SKF products may be used only for their intended purpose as described in these assembly instructions with associated operating instructions. If assembly/operating instructions are supplied together with the products, they must be read and followed. Not all lubricants can be fed using centralized lubrication systems. SKF can, on request, inspect the feedability of the lubricant selected by the user in centralized lubrication systems. Lubrication systems and their components manufactured by SKF are not approved for use in conjunction with gases, liquefied gases, pressurized gases in solution, vapors or such fluids whose vapor pressure exceeds normal atmospheric pressure (1013 mbar) by more than 0.5 bar at their maximum permissible temperature.

Particular attention is called to the fact that hazardous materials of any kind, especially the materials classified as hazardous by EC Directive 67/548/EEC, Article 2, Para. 2, may only be filled into SKF centralized lubrication systems and components and delivered and/or distributed with the same after consultation with and written approval from SKF.

SKF Lubrication Systems Germany AG

Motzener Straße 35/37 · 12277 Berlin · Germany
PF 970444 · 12704 Berlin · Germany
Tel. +49 (0)30 72002-0 · Fax +49 (0)30 72002-111
www.skf.com/lubrication

SKF Lubrication Systems Germany AG

2. Industriestrasse 4 · 68766 Hockenheim · Germany
Tel. +49 (0)62 05 27-0 · Fax +49 (0)62 05 27-101
www.skf.com/lubrication

