

## 2-Way Flow Regulator, Pressure Compensated

# VSS3-062/S

M22 x 1.5 •  $Q_{max}$  40 l/min (11 GPM) •  $p_{max}$  320 bar (4600 PSI)

### Technical Features

- › Set flow rate independent of load pressure and temperature changes
- › Adjusted flow rate depends on the orifice area and set differential pressure
- › Hardened precision parts
- › High flow capacity
- › Quiet and modulated response to load changes
- › Used in meter-in, meter out, or bleed-off applications
- › Wide range of flow rate options
- › Adjustable by allen key or hand screw
- › In the standard version, the valve is zinc-coated for 240 h protection acc. to ISO 9227

### Functional Description

This pressure compensated, hydraulic flow regulator in the form of a screw-in cartridge with fixed orifice and variable spring setting is designed to control flow rates independently of pressure and temperature, especially in systems where only small movements due to load changes are required. The flow rate stabilization is provided by a pressure compensator in the direction from A to B. The valve will maintain the set flow regardless of pressure variations on the regulated or inlet port.

In flow direction B - A, the valve works as an ordinary throttle valve without pressure compensation. The regulated flow increases with clockwise rotation of the adjustment screw and decreases with counter-clockwise rotation. The desired settings can be locked down.

The valve will maintain the set flow regardless of pressure variations on the regulated or inlet port.

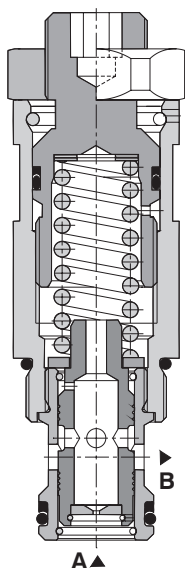

Symbol

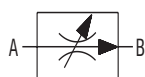

### Technical Data

Valve size / Cartridge cavity		M22x1.5 / QG2						
Nominal flow rates	l/min	1.6	2.5	4	6.3	10	16	20
	(GPM)	(0.4)	(0.7)	(1.1)	(1.7)	(2.6)	(4.2)	(5.3)
Max. operating pressure	bar (PSI)	320 (4640)						
Fluid temperature range (NBR)	°C (°F)	-30 ... +80 (-22 ... +176)						
Fluid temperature range (FPM)	°C (°F)	-20 ... +80 (-4 ... +176)						
Mass	kg (lbs)	0.19 (0.42)						

		Datasheet	Type
General information		GI_0060	Products and operating conditions
Valve bodies	In-line mounted	SB_0018	SB-QG2-*
	Sandwich mounted	SB-04(06)_0028	SB-*QG2*
Cavity details / Form tools		SMT_0019	SMT-QG2*
Spare parts		SP_8010	

### Characteristics measured at $v = 32 \text{ mm}^2/\text{s}$ (156 SUS)

#### Regulated flow related to input pressure

Flow direction A - B (regulated flow)

Flow rate 1.6

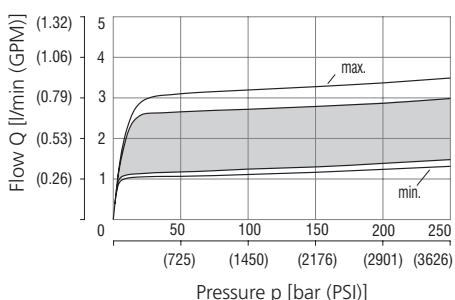

Flow rate 2.5

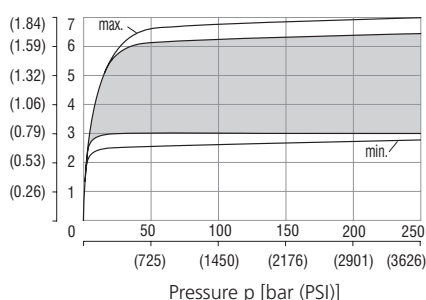

Flow rate 4

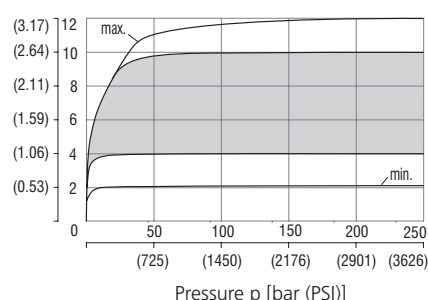

**Characteristics** measured at  $v = 32 \text{ mm}^2/\text{s}$  (156 SUS)

**Regulated flow related to input pressure**

Flow direction A - B (regulated flow)

Flow rate 6.3

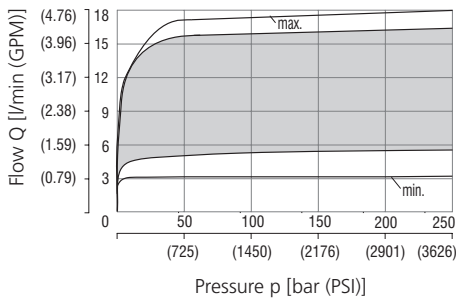

Flow rate 10

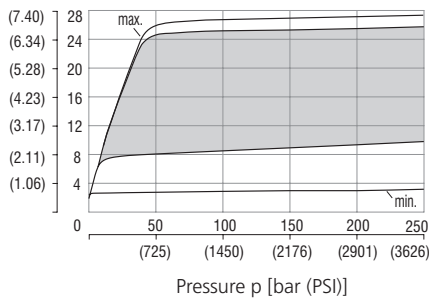

Flow rate 16

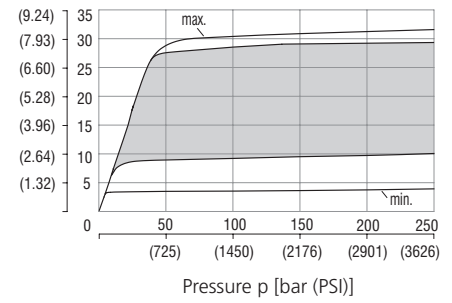

Flow rate 20

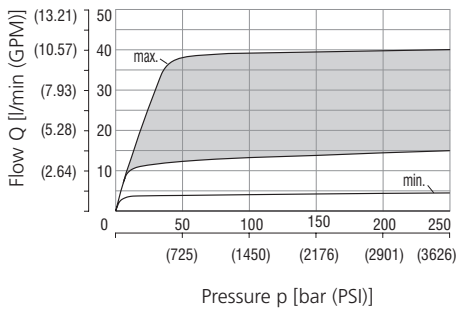

**Pressure drop related to flow rate**

Flow direction B - A  
(throttling without compensation)

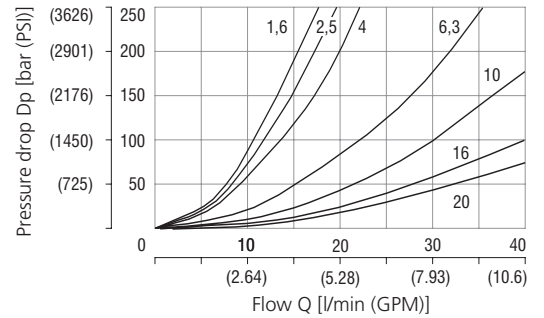

**Dimensions** in millimeters (inches)

**Model S**

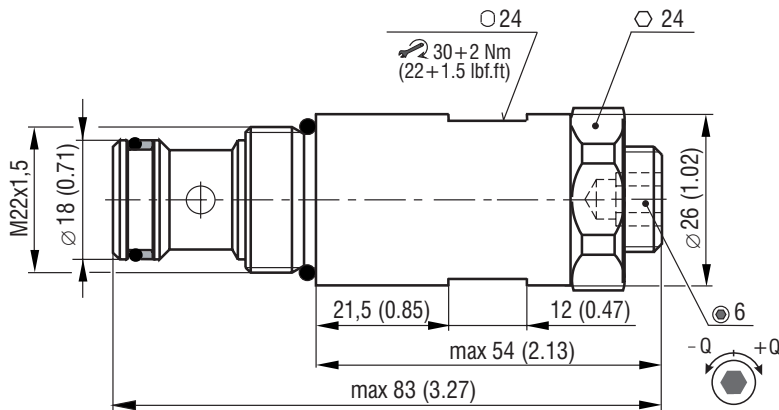

**Model RS**

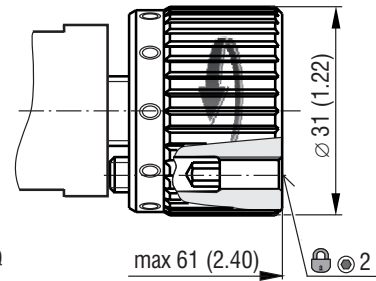

**Ordering Code**

VSS3-062/S- [ ] [ ] [ ] - [ ]

**2-Way flow regulator, pressure compensated  
M22x1.5**

**Model**  
screw-in cartridge

Flow rate		
1.4 - 2.7 l/min	(0.4 - 0.7 GPM)	1.6
3 - 6 l/min	(0.8 - 1.6 GPM)	2.5
4 - 10 l/min	(1.1 - 2.6 GPM)	4
5 - 16 l/min	(1.3 - 4.2 GPM)	6.3
8 - 25 l/min	(2.1 - 6.6 GPM)	10
9 - 28 l/min	(2.4 - 7.4 GPM)	16
12 - 40 l/min	(3.2 - 10.6 GPM)	20

**Surface treatment**  
A zinc-coated (ZnCr-3), ISO 9227 (240 h)  
B zinc-coated (ZnNi), ISO 9227 (520 h)

**No designation**  
V

**Seals**  
NBR  
FPM (Viton)

S  
RS

**Adjustment option**  
allen key (hex. 6), without protective cap  
hand screw, metal-short