

# Optimizing wind farm performance

with SKF WindLub automatic lubrication systems





Thousands of wind turbines around the world operate more reliably and efficiently thanks to SKF and Lincoln automatic lubrication systems. Onshore and offshore, in the earth's most extreme environments, from deserts to frozen tundra, wind farm operators benefit from precise automatic lubrication of critical moving components.



SKF and Lincoln have joined forces to provide the world's most complete portfolio of lubrication solutions, from manual lubricators to the most advanced centralized and automatic lubrication systems on the market. Together, we provide a full range of lubrication tools and expert services, from turnkey installation and set-up to testing and training.



Drawing on more than 200 years of combined friction management experience, we can help you improve machine reliability, reduce maintenance costs, improve productivity, enhance safety and optimize manpower resources.

# Two leading brands. One global resource.

## Leveraging our combined knowledge for the wind industry



Why SKF and Lincoln lubrication systems? In a word, experience. Over the decades, our lubrication system solutions have been used successfully in virtually every industry, from manufacturing and railway to marine and mining. We have drawn upon our combined experience in these and other fields to develop high-efficiency automatic lubrication systems tailored specifically to the needs of the wind energy industry.

With the combination of SKF and Lincoln lubrication portfolios and capabilities, you now have one go-to resource for best-in-class lubrication services and advanced automatic lubrication systems.

## Improving turbine performance through automatic lubrication

Like any mechanical system, a wind energy system needs proper lubrication to function optimally. Vibration, high mechanical loads, contamination and moisture are all threats to bearing and gear service life. However, wind turbines can be challenging and expensive to service. They can reach more than 100 meters off the ground and are often in remote and difficult-to-access locations.

The solution is an automatic lubrication system. Compared to manual lubrication, automatic lubrication systems provide lubricant supply more reliably and precisely to moving components in the nacelle. By delivering the smallest effective amount of lubricant reliably to all friction points while the machine is



running, automatic lubrication systems reduce friction inside bearings and help prevent contamination. The result is optimized bearing service life over the long term, more turbine uptime and reduced manpower costs – all combining to help make wind farms more profitable.

## Automatic lubrication systems pay back quickly

Automatic lubrication systems can provide a quick return on investment by increasing turbine system availability, extending maintenance intervals and preventing failures of major components. Additional savings can be achieved through proper lubricant handling and consumption. SKF and Lincoln automatic lubrication systems are unmatched in their ability to deliver these benefits and many more.

### SKF and Lincoln – A powerful formula for reliability:

- **Superior product innovation:**  
The broadest and most advanced lubrication offering in the industry
- **Unequaled global support:**  
Two teams of lubrication experts join forces
- **World-class installation support:**  
The combined expertise to install the right solution

To explore our solutions, visit [skf.com/TheFormula](https://www.skf.com/TheFormula)

# A complete portfolio of lubrication solutions to improve system reliability

## Avoid bearing damage

Studies have revealed that 36 percent of all premature bearing damage is due to improper lubrication. Combine that with the percentage of bearing damage that results from the use of contaminated lubricants and the number rises to 50 percent. A properly designed and executed lubrication programme helps prevent lubrication-related damage and supports optimum bearing performance and service life.

## Automatic lubrication systems

SKF and Lincoln automatic lubrication systems deliver the exact quantity of the appropriate lubricant to the right place at the right time.

In addition to helping increase reliability and availability, the systems help to extend service life, reduce operational and lubricant costs and minimize environmental impact by avoiding over-greasing.

SKF also can assist you in optimizing lubrication settings and intervals, and in developing a customized lubrication programme. A global network of service partners supports you in optimizing your farm performance.

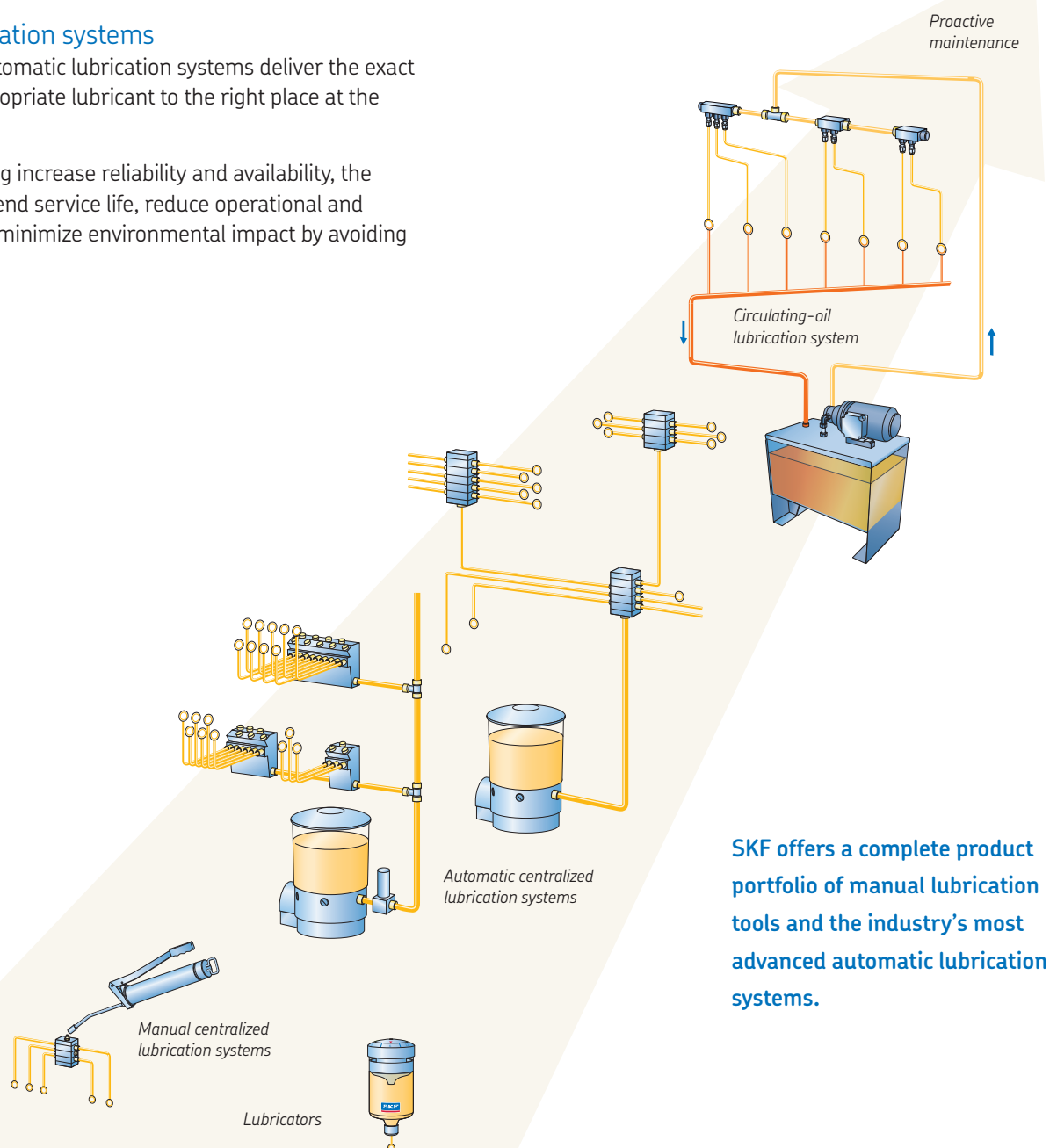

**SKF offers a complete product portfolio of manual lubrication tools and the industry's most advanced automatic lubrication systems.**

# Maximize turbine availability, minimize maintenance tasks and costs



## Maximize availability

Precise automatic lubrication provides a significant benefit for operators under increasing pressure to maximize energy production and manage operating costs. Reliably delivering lubricant from a central source to all of the connected friction points of the power generation system, SKF and Lincoln automatic lubrication systems help prevent bearing damage and unscheduled turbine downtime, while optimizing manpower resources.

## Reduce operating costs

The high quality of SKF and Lincoln automatic lubrication systems pays off in many ways. For one, you can lower lubrication consumption by up to 50 percent, which is particularly important when using more expensive lubricants. Furthermore, the systems function virtually maintenance-free. Operators have the option to receive automatic notification when lubrication reservoirs require re-filling. All of this means reduced operating costs and, ultimately, improved wind farm profitability.

### Maintenance benefits

- Reduces labour costs
- Extends repair intervals
- Eliminates over- and under-greasing

### Operational benefits

- Increases turbine reliability
- Reduces unplanned downtime
- Improves wind farm profitability

### Safety benefits

- No manual lubrication in dangerous, difficult-to-access points
- Reduces risk of slips and falls through precise lubrication



No: DAA-GL026-2010

## GL Renewables certification for SKF WindLub lubrication systems

In some instances, wind turbine technology requires approval by a certification body. For off-shore wind farms, in particular, specific requirements for turbine technology are tested and certified. SKF lubrication systems were the first to receive this certification.

# Solutions for every wind turbine application

SKF offers lubrication system solutions tailored to every turbine application. Single-line and progressive automatic lubrication systems are available for pitch bearings, pitch open gears, main bearings, yaw bearings, yaw open gears and generators, while circulating oil systems are available for gearboxes. SKF also offers lubrication pinions for gear drives and suction elements that remove used grease from bearings.

## Pitch bearings

Pitch bearings require a constant re-supply of lubricant. The lubrication unit responsible for this is mounted in the rotor and continually turns with the rotor, adjusting to the resulting vibration and centrifugal force. SKF and Lincoln grease pumps, fitted with a grease follower plate, help ensure that grease is in the area of the pump elements, enabling suction even with rotation. From there, the grease arrives at the metering devices through a progressive or single-line lubrication system.

## Pitch open gears

Rotor blades can be electrically adjusted in wind turbine generators. Lubrication for the pitch open gear is supplied via SKF and Lincoln pumps for the rotary application. For rotating operation in wind turbines, the reservoir is equipped with a follower plate and stirring paddle. SKF and Lincoln lubrication pinions apply grease precisely to the area of contact on the drive pinion or the pitch open gear and evenly lubricate the entire cog width.

## Yaw bearings and yaw open gears

An electrical grease pump introduces lubricant into the yaw bearing via progressive or single-line metering devices. Use of an automatic lubrication system helps to achieve a sufficiently thick lubricant film to prevent excessive wear and the “stick-slip” effect upon turning the nacelle. The automatic lubrication pinion meshes precisely onto the gearing, distributing the lubricant in the area of contact precisely and uniformly across the entire cog width. Used grease is systematically removed by the lubricant collector and caught in a collection tank to prevent it from dripping on the nacelle floor. This helps improve worker safety.

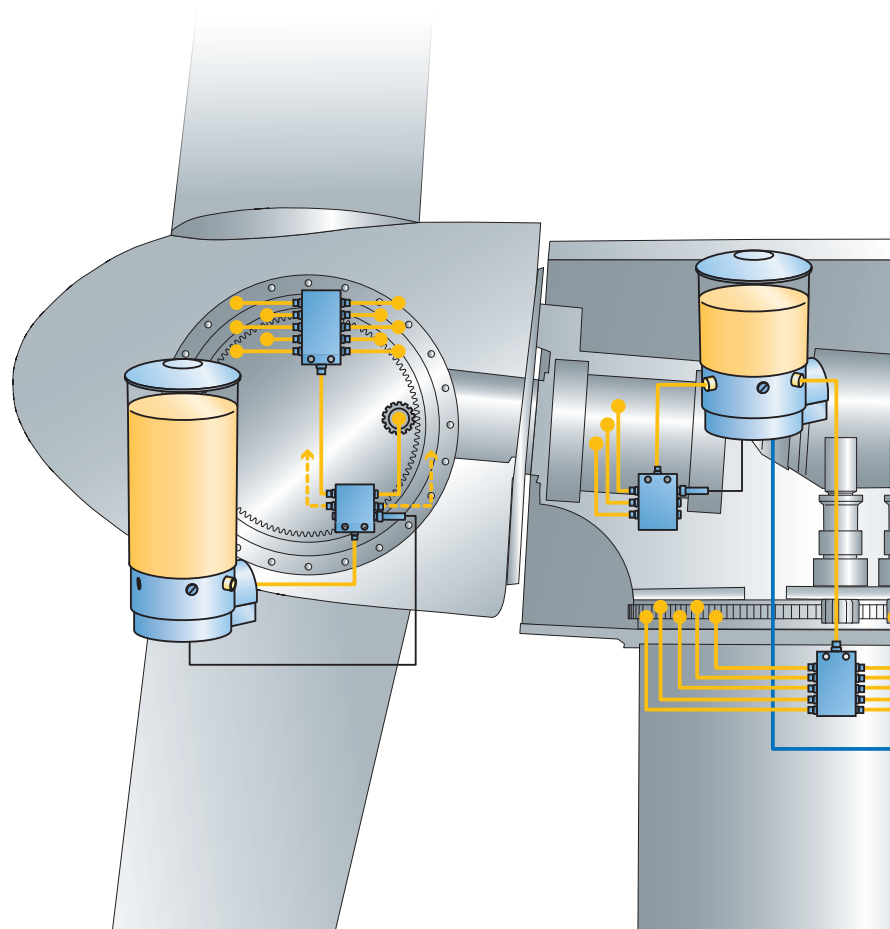

## Main bearings

The main bearings of a wind turbine are subject to severe forces and usually require large quantities of lubricant. This is where the complete series of SKF and Lincoln standard pumps for wind turbine generators comes into play. For stationary operation, a stirring and fixed paddle in the pump's reservoir is sufficient. The automatic lubrication system continually supplies grease to the main bearings even while in motion.

## Gearboxes

Oil serves several tasks in the gearbox. It lubricates and cools the lubrication points. Filters then remove contaminants from the oil cycle. Electric heaters can be used to enable optimal start-up temperature in the lubrication cycle in case of cold external temperatures. Flow limiters maintain the prescribed oil volume flow independent of pressure and temperature changes and provide feedback on the current flow rates on request.

## Generators

High temperatures and speeds inside the generator require specially formulated lubricants and an efficient automatic lubrication system. In addition, greases can become stiff at low temperatures. SKF and Lincoln pump units help to ensure that the lubrication points are supplied with lubricant even in the most extreme conditions.

## Control and monitoring

Automatic lubrication systems can be started and monitored by the wind energy system control. Alternatively, lubrication systems can also be equipped with integrated controls, to work independently from the wind energy system.

The SKF WindCon Lubrication Interface links SKF WindCon and SKF Windlub, which features SKF and Lincoln lubrication systems. It allows the operator to monitor lubrication system health and the amount of grease applied to the bearing, as well as offers the ability to remotely trigger a lubrication cycle.

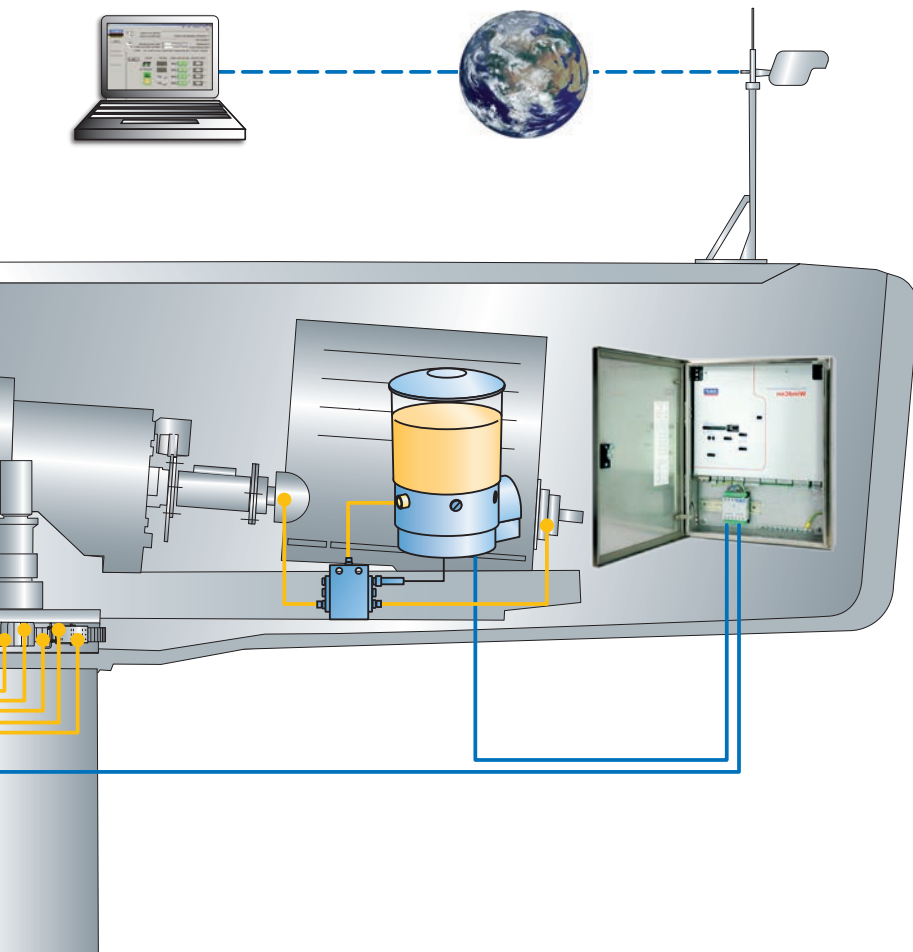

# Improve reliability with scalable, single-line lubrication systems



In single-line lubrication systems, a pump feeds the lubricant via the main line to the lubricant metering devices, where it is metered and fed to the lubrication points. The individual lubricant requirements for each lubrication point can be adjusted.

## Advantages:

- Scalable system planning thanks to modular design
- Suitable for almost all lubricants
- System continues to work if a lubrication point clogs
- Support for integrated control unit

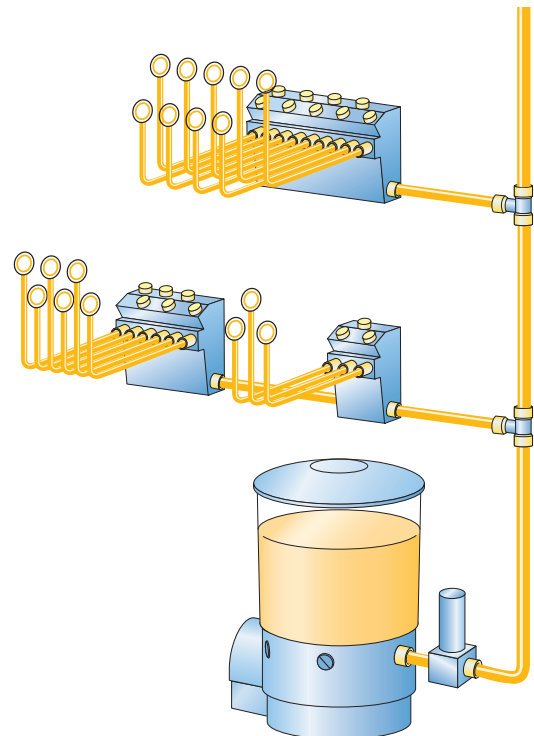



## Complete range of products

The SKF portfolio consists of both SKF MonoFlex and Lincoln Centro-Matic system components, including pumps, metering devices, control and monitoring devices, and suction elements. All components are suitable for standard greases up to NLGI Grade 2 and for use in low working temperatures.

## The precise pumps for your application

Various criteria, such as environmental conditions, required delivery rate and maintenance intervals, determine the choice of lubricant pump. SKF offers a comprehensive range of electrically driven pump units, delivered with or without an integrated control unit:

- Reservoir capacity: 2–20 litres (0.5–5.3 gallons)
- Pressures from 200–300 bar (2,900–4,350 psi)
- Delivery volumes from 4–25 cm<sup>3</sup>/min

The P603S/653S and the KFG pumps are available in stationary and rotary designs to be used in pitch bearings and pitch open gears, as well as in main and yaw bearings. All KFG and P603/653 pump variants are available in saltwater-resistant versions. Individual components are coated for protection against corrosion (corrosion class C5 M) and combined with stainless steel components.

The P603/653 pumps incorporate an internal connection of the lubricant quantity from one to three pump elements. The pump's innovative design packages the pump, controller, vent valve and pressure switch or transducer in one compact unit. KFG pumps offer a top-fill option. This helps mix the grease directly under the follower piston to prevent old grease from remaining in the system.



## Exact metering for each component

SKF and Lincoln single-line lubricant metering devices are high-precision components, available in special materials for various climates. VR devices feature high-pressure resistance (315 bar (4,568 psi)) and a high relief pressure (30 or 70 bar (435 or 1,015 psi)). Every lubrication point can be visually monitored using indicator pins. The metal-to-metal fit of the QSL devices makes them suitable for high pressure as well. Each metering device's output can be individually set. Though metering device function is usually visually monitored, optional electrical monitoring or a GSM-controlled system is available.

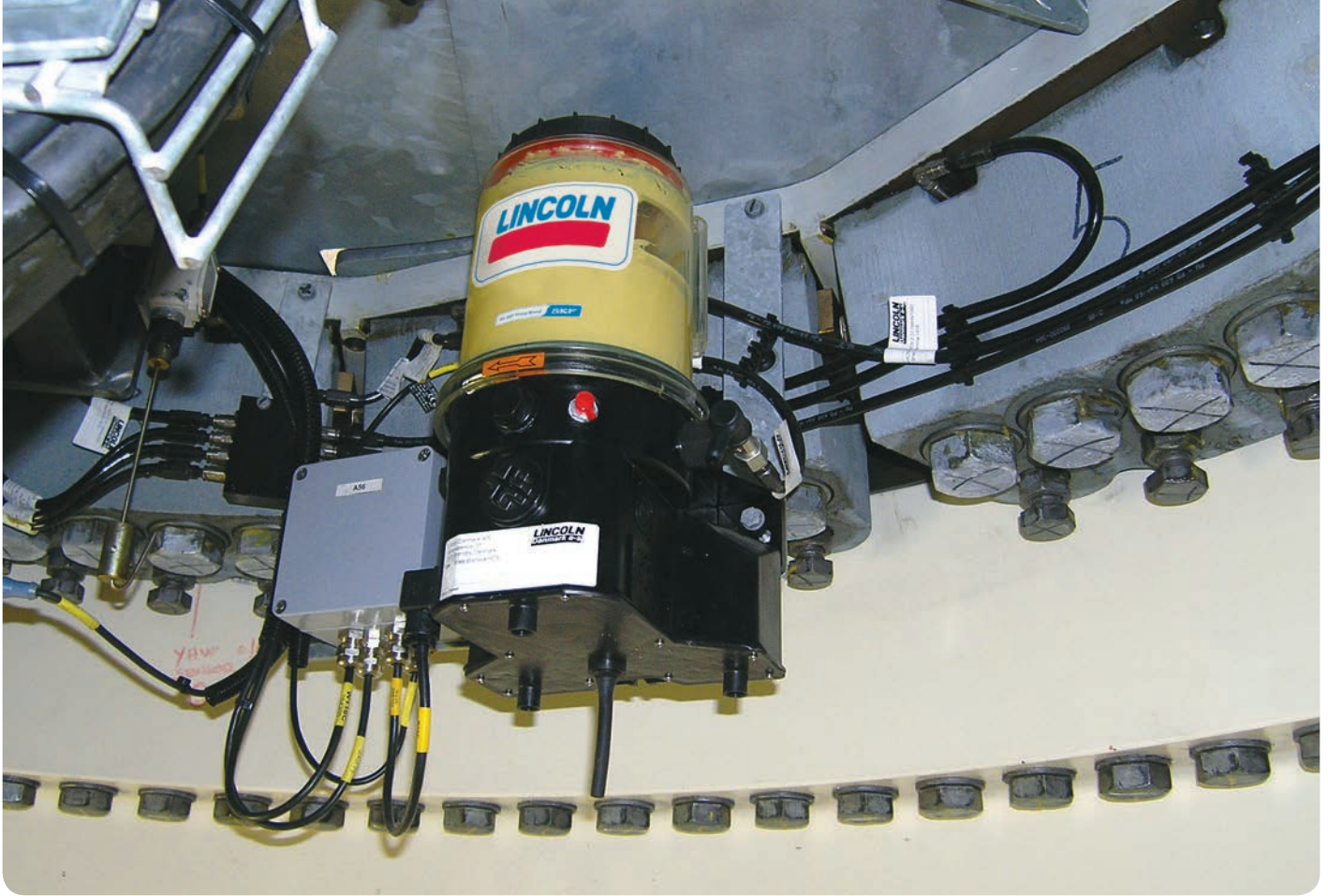

## Continuous lubrication with customized progressive systems

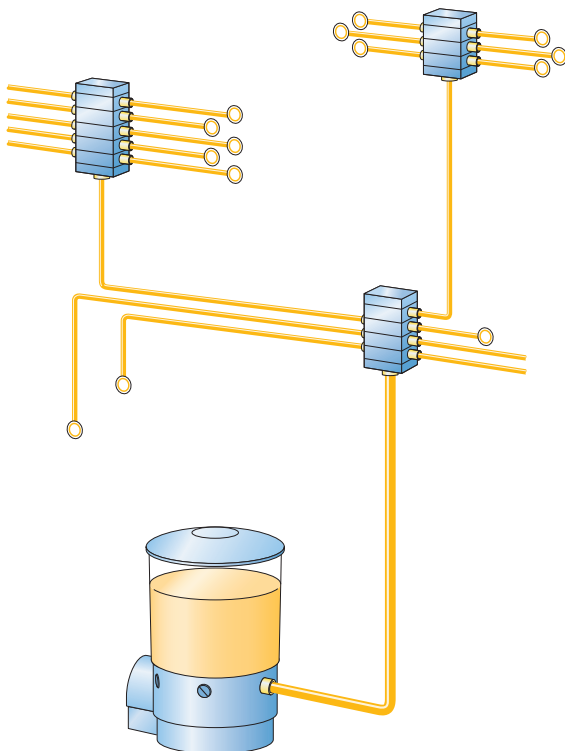

In progressive automatic lubrication systems, a piston pump supplies a defined amount of lubricant through the main line to the metering device that serves each outlet.

### Advantages:

- Continuous delivery of lubricant during pump running time
- Easy system monitoring
- Support for integrated control unit

Each SKF ProFlex and Lincoln Quicklub system is designed for a specific application and can be configured to meet the unique lubrication requirements of every lubrication point on the machine.

### Comprehensive range of lubrication pumps

The SKF line includes the SKF KFG and Lincoln P203, P301 and P401 pumps, the standard choices for progressive systems. Designed with integrated controls, the pumps that power the system are programmed to activate at regular, pre-determined intervals while the equipment is running. The pump housings are weather resistant, saltwater-resistant versions are available. The pumps are suitable for standard greases up to and including NLGI Grade 2 and for use in low working temperatures.

- **Reservoir capacity: 2–20 litres (0.5–5.3 gallons)**
- **Number of pump elements: 3**
- **Delivery volumes: 0,8–5 cm<sup>3</sup>/min**

### Complete, compact systems – ready to install

SKF can supply a complete, compact grease lubrication system that includes all necessary monitoring and control functions. The integrated, all-in-one Lincoln QLS 401 system reduces installation time and costs with a built-in internal metering device. Up to 18 lubrication points can be supplied and monitored directly from the pump.

### Reliable progressive lubricant metering devices

Available in block construction or as sectional feeders, SKF and Lincoln metering devices are sturdy and easy to install. Lubricant is distributed accurately, even with high back pressure at lubrication points due to fitted pistons and check valves installed at the outlets. System operation can be verified easily through electronic or visual monitoring of a single piston.

Individual components are coated for protection against corrosion (corrosion class C5 M) and combined with stainless steel components.



# Lubrication pinions and lubricant collection systems

SKF and Lincoln lubrication pinions do all the work when it comes to automatic lubrication of open gear rims in wind turbines. They provide optimum lubricant distribution to the tooth flanks across the entire cog width. Suction elements and lubricant collectors gather excess grease directly on the system's lubricating gears to prevent it from exiting into the environment or contaminating the system when the gearing engages.

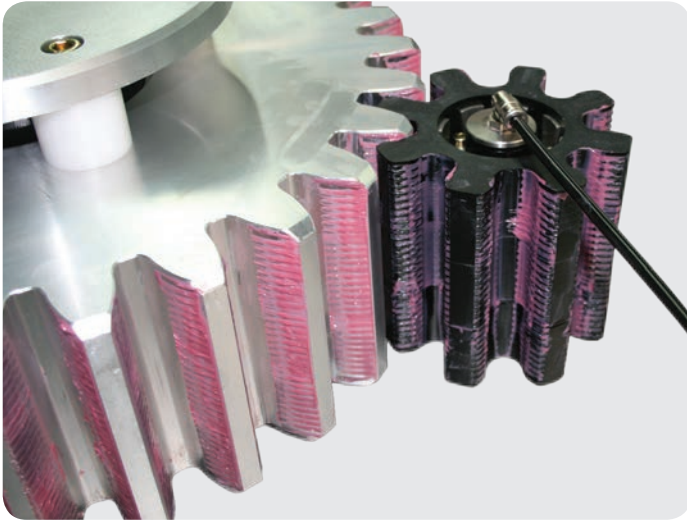

## Lubrication pinions for efficient lubricant application

SKF and Lincoln lubrication pinions are optimal solutions for supplying lubricant to gear rims, one tooth at a time. Lubrication is applied only where it is needed.

SKF's mechanical application method, along with robust materials including metal and polyurethane PU, provide long service life even under adverse conditions. Lubrication pinions are available in pinion heights from 80–270 mm (3.15–10.63 in) and diameters from 112–220 mm (4.4–8.66 in).

## Suction elements and grease collectors

External suction elements, which were specifically developed for single-line lubrication systems, are an alternative to large pans or collecting scoops. These suction elements cleanly remove used grease from a bearing for collection in a used grease container. Recycling the used grease reduces environmental impact and keeps the area around the bearing cleaner and safer.



# Circulating oil systems

In contrast to total loss lubrication systems, the oil in circulating oil systems is fed back through the return line into the oil reservoir for reuse after it passes through the lubrication point. In addition to lubricating, circulating oil lubrication stabilizes lubrication points to the proper temperature, cools gearboxes, removes and filters out wear particles from friction points, prevents corrosion damage and removes water condensation.

## SKF CircOil

SKF CircOil systems include a wide range of tailor-made and turnkey solutions for flow rates from 0,1 to 200 l/min. The systems provide efficient cooling and lubrication of gearboxes, as well as water and air separation. SKF CircOil also features integrated condition monitoring and demand-based distribution of lubricant, which can be monitored. Simple to service, SKF CircOil systems feature a modular design that can be expanded easily.

## Flow dividers



Flow dividers used in SKF CircOil lubrication systems separate the volumetric flow of the main line into parallel individual volumetric flows and limit these according to demand. Sensor or gear-type flow indicators are used to monitor the volumetric flow. They provide an almost constant flow rate due to pressure-compensated technology, regardless of oil viscosity and pressure changes.

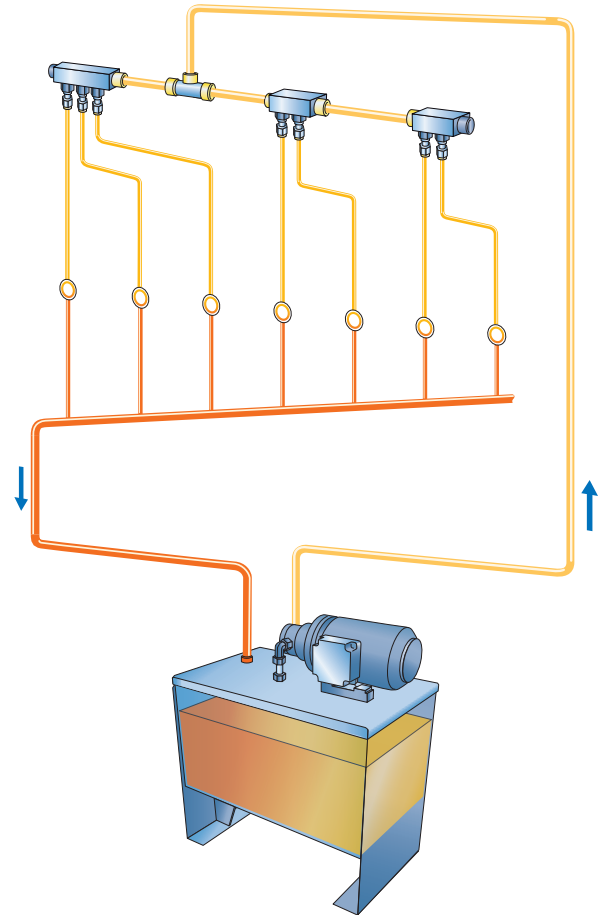

# System monitoring

Monitoring and control are essential to the efficient operation of modern wind turbines. Intelligent monitoring devices allow operators to oversee automatic lubrication system health.



## SKF WindCon online condition monitoring system

By enabling operators to monitor and track deteriorating component conditions in real time, SKF WindCon enables maintenance decisions to be based on actual machine conditions, rather than arbitrary maintenance schedules. Along with the possibility that maintenance intervals can be extended, the system provides a powerful tool for managing day-to-day maintenance routines and consolidating risky, costly maintenance activities. Data can be uploaded to SKF remote monitoring centres, operating globally 24–7, for expert analysis and reporting.

## SKF WindCon Lubrication Interface

With the SKF WindCon Lubrication Interface in place, the SKF WindCon system can communicate with the SKF or Lincoln lubrication pump.

This solution enables the SKF WindCon system to automatically monitor the system, including pump status and grease levels. If failures such as empty or blocked pumps or torn feed lines are detected, operators are notified immediately.

SKF WindCon Lubrication Interface helps operators optimize bearing life, plan repairs and prevent cascading bearing failures, thereby extending maintenance intervals. For wind turbine operators, this added lubrication functionality keeps maintenance crews on the ground, eliminating the need to travel to remote locations to manually lubricate bearings. It also helps reduce life cycle energy costs, since poorly functioning bearings can increase energy use. For original equipment manufacturers, this system can help increase equipment reliability and product value.

### Piston detector for progressive systems

The seal-free, attached piston detector on the progressive feeders monitors the function of the feeders and provides a feedback signal to the downstream monitoring system.

### Pressure switch for single-line systems

If pressure losses of greater than 10 bar are expected in a single-line system (example: due to viscosity of lubricant depending on ambient temperature), a pressure switch can be mounted at the end of the main line. The pressure switch monitors whether the required pressure build-up occurs in the system during the lubrication cycle.

### Gear-type flow indicator for circulating oil systems

Gear-type flow indicators and sensors are used as a monitoring system in flow limiters. While the sensor transfers function monitoring via an analog signal, this information is transferred via a digital signal in the case of gearwheel-type flow indicators (NAMUR).



# Safer, more efficient refilling

SKF offers a range of tools and equipment for safely and efficiently refilling automatic lubrication systems. By reducing time spent climbing the tower, these solutions help protect your people – and your profits.



Turbines require large volumes of grease to be dispensed during each lubrication maintenance session. Even though SKF WindLub centralized lubrication systems require minimal maintenance, lubricant must be refilled from time to time. Tower heights and tight working spaces create unique challenges for maintenance workers.

## Simplify maintenance with electric grease filling pumps and lubers

SKF offers intelligent solutions for convenient maintenance in the nacelle, including a wide range of electrically driven filling pumps and grease tools that provide long run times.

**Universal Electric Grease Feeding Pump (EFFP):** Equipped with large wheels that roll safely over both rough and smooth ground, the EFFP also has two handles and a bracket that attaches to a hoist to simplify transport up to the nacelle. In wind turbines without an automatic lubrication system, its long hose line allows manual lubrication of all points without having to move the pump. It also can be equipped with a grease gun, either with or without volumetric meter. The EFFP is currently available in Europe and Asia.



**Lincoln electric grease transfer pumps (GTP):** Transfer pumps provide an ideal solution for filling reservoir-type pumps. These electric pumps handle a range of capacities, outputs and pressures, and are suitable for either mobile or stationary drums as large as 200 kg. The GTP is currently available in Europe and Asia.

**Electric PowerLuber:** With the Electric PowerLuber, a variable-speed trigger allows the operator to choose medium pressure for high-volume dispersion or high pressure for standard-volume dispersion. These UL-approved tools feature a pressure-relief valve for added safety. The Electric PowerLuber is currently available in the North America.

### Battery-operated filling pumps and lubers

In addition to the Electric PowerLuber, the PowerLuber is available in 14,4-volt or 18-volt battery-powered versions. These PowerLubers feature a two-speed switch for high-pressure or high-volume delivery and a cycle indicator pin to monitor grease output.

They also come with a one-hour charging system, which delivers reliable power for filling operation.

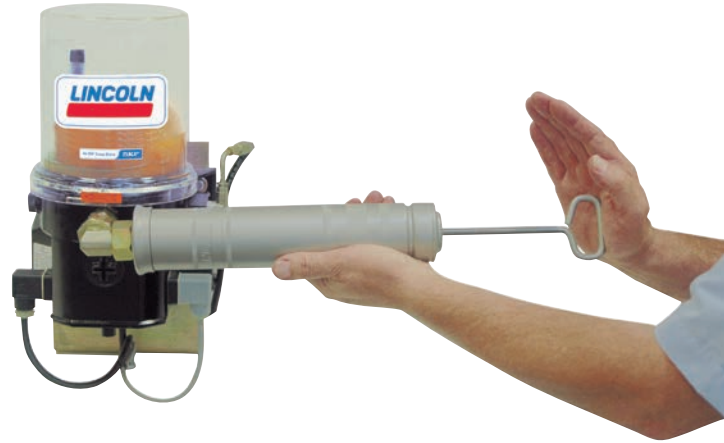

### Fast filling with manual grease filler pumps

In addition to electric solutions, SKF offers quick-filling, manual grease filler pumps with a special pump adapter. Filling pump reservoirs takes a fraction of the time that normally would be required using conventional manual grease tools.



# Service solutions from SKF

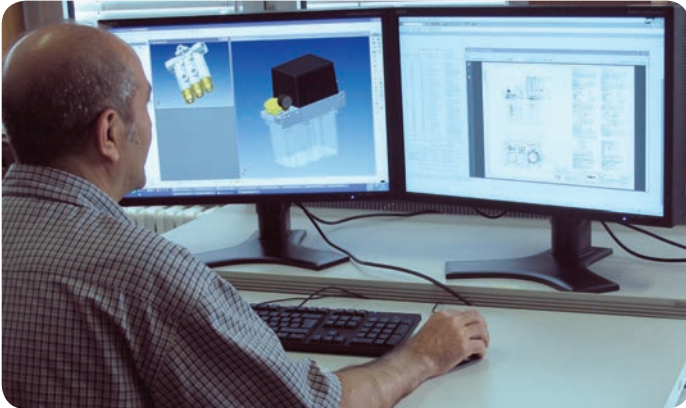

**Design in 3-D and electronic CAD product catalog**  
3D CAD data are available in native format in the online product catalog, which is based on the eCATALOGsolutions technology by CADENAS GmbH. You can configure your products online from the centralized lubrication area and integrate them into your design process free of charge. You can integrate the CAD data seamlessly into your layout plans.

The SKF LubCAD app allows you to use the SKF CAD download portal for lubrication systems with its full functionality for your mobile devices.

Access our online catalogue at  
<http://skf-lubrication.partcommunity.com>



## Retrofitting centralized lubrication systems

Maintenance and repair costs during system downtime quickly can become unwieldy. That's why we also offer on-site professional retrofitting of centralized lubrication systems at your location. We also can assume responsibility for maintenance and repair during ongoing operations.

In addition, our portfolio includes other solutions that can simplify maintenance for you, from an electric refilling pump which has been optimized for the conditions inside wind energy turbines, to appropriate fittings and accessories.



## Procurement logistics and synchronized production

We can tailor our logistics processes to the requirements of our customers. For example, using synchronized electronic KANBAN systems with first-in-first-out logistics, we enable an inventory-free supply for manufacturing and assembly that is synchronized with production.

As a result, run-through times and total outlays are optimized, and the risk of loss and damage is reduced. This results in optimum supply chain management, whether your needs are exclusively local or global.

# Global experience, global support

## More than 200 years of combined SKF and Lincoln experience

SKF has been involved in the wind industry since its inception and offers deep knowledge of the complicated mechanical interrelationships inherent in wind energy technology. Combining the worldwide experience, portfolios and distribution networks of both the SKF and Lincoln brands, SKF offers the industry's most complete range of lubrication management solutions anywhere on the planet.

Whatever the size or design of your turbines, SKF has the products and resources to help you increase bearing life, turbine uptime and nacelle safety, while minimizing manpower hours, maintenance costs and environmental impact.

## A network of experienced partners

SKF- and Lincoln-branded products, systems and services are available through a global network of distributor partners, supported by one unified sales organization committed to your success. Systems house distributors around the world offer turnkey solutions and extensive aftermarket support. In addition to maintaining a local inventory of system components and spare parts, these factory-trained lubrication specialists can provide:

- **Customized lubrication system design**
- **System installation and start up**
- **Service and repair**
- **Lubrication analysis and testing**
- **Lubrication management training**
- **Warranty support**
- **System maintenance contracts**
- **Wind farm surveys and recommendations**
- **Return-on-investment (ROI) analysis**
- **Guidance on safety and environmental issues**
- **Pre-assembled lubrication kits for easy retrofitting available**



## Here for you, wherever you are

With lubrication application centres located on every continent and a worldwide distributor network, SKF has the people, products and support you need to optimize your lubrication management programme. For more information, contact your SKF representative or visit [skf.com/TheFormula](https://www.skf.com/TheFormula).

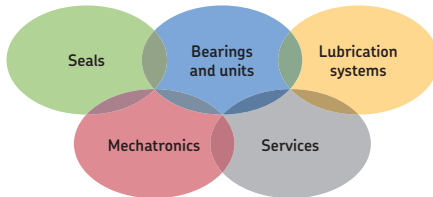

### The Power of Knowledge Engineering

Combining products, people, and application-specific knowledge, SKF delivers innovative solutions to equipment manufacturers and production facilities in every major industry worldwide. Having expertise in multiple competence areas supports SKF Life Cycle Management, a proven approach to improving equipment reliability, optimizing operational and energy efficiency and reducing total cost of ownership.

These competence areas include bearings and units, seals, lubrication systems, mechatronics, and a wide range of services, from 3-D computer modelling to cloud-based condition monitoring and asset management services.

SKF's global footprint provides SKF customers with uniform quality standards and worldwide product availability. Our local presence provides direct access to the experience, knowledge and ingenuity of SKF people.

© SKF, MonoFlex and WindLub are registered trademarks of the SKF Group

© Lincoln, Centro-Matic, PowerLuber and Quickclub are registered trademarks of Lincoln Industrial Corp.

™ ProFlex and CircOil are trademarks of the SKF Group

GL Certification is a registered trademark of Germanischer Lloyd SE

© SKF Group 2015

The contents of this publication are the copyright of the publisher and may not be reproduced (even extracts) unless prior written permission is granted. Every care has been taken to ensure the accuracy of the information contained in this publication but no liability can be accepted for any loss or damage whether direct, indirect or consequential arising out of the use of the information contained herein.

**PUB LS/S2 14161 EN** · February 2015 · **1-2020-EN**

This publication supersedes publications 10186, 13122, 13187 and FORM 444052.

Certain image(s) used under license from Shutterstock.com