

# KFG; KFGS; KFGL; KFGC (CAN bus) for industrial applications

Assembly instructions acc. to EC Dir. 2006/42/EC  
for partly completed machinery with associated operating instructions

EN

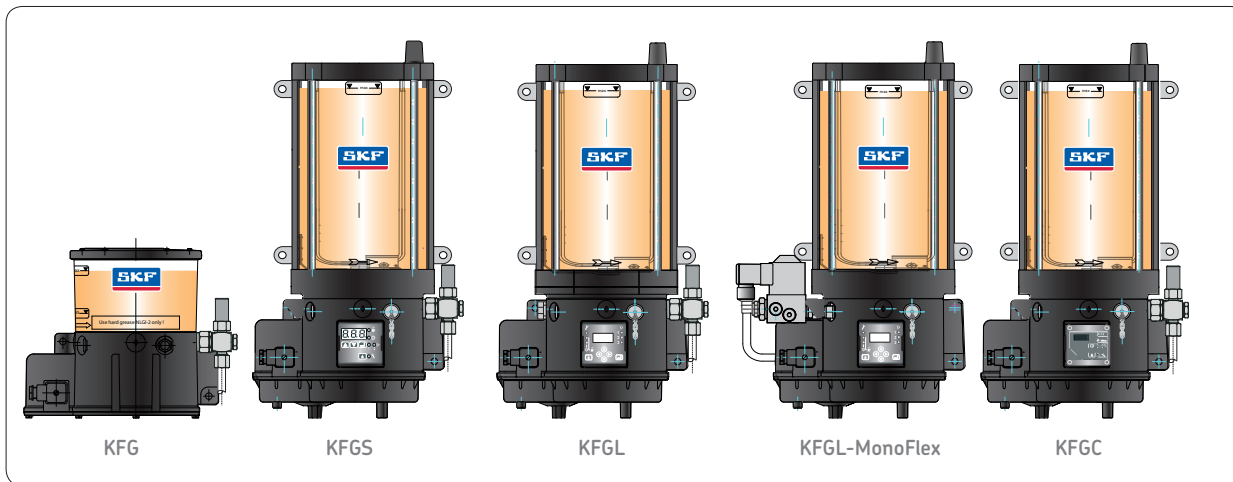

## Masthead

These assembly instructions with associated operating instructions according to EC Machinery Directive 2006/42/EC are an integral part of the described product and must be kept for future use.

These assembly instructions with associated operating instructions have been prepared in accordance with the established standards and rules for technical documentation, VDI 4500 and EN 292.

## © SKF Lubrication Systems Germany GmbH

This documentation is protected by copyright. SKF Lubrication Systems Germany GmbH reserves all rights, including those to the photo-mechanical reproduction, duplication, and distribution by means of special procedures (e.g., data processing, data media, and data networks) of this documentation in whole or in part.

Subject to changes in contents and technical information.

## Service

If you have technical questions, please contact the following addresses:

### SKF Lubrication Systems Germany GmbH

#### Berlin Plant

Motzener Strasse 35/37  
12277 Berlin, Germany  
Germany

Tel. +49 (0)30 72002-0

Fax +49 (0) 30 72002 111

#### Hockenheim Plant

2. Industriestrasse 4  
68766 Hockenheim  
Germany

Tel. +49 (0)62 05 27-0

Fax +49 (0) 62 05 / 27-101

lubrication-germany@skf.com  
[www.skf.com/schmierung](http://www.skf.com/schmierung)

## Assembly instructions table of contents

<b>Information concerning EC Declaration of Conformity and EC Declaration of Incorporation</b>	<b>6</b>				
<b>Explanation of symbols and signs</b>	<b>7</b>				
<b>Documentation overview</b>	<b>8</b>				
<b>1. Safety instructions</b>	<b>8</b>				
1.1 Intended use	9	4.2.3 Mounting dimensions, Design 24 VDC, without control unit	19	<b>4.6.2 KFGS series</b>	<b>31</b>
1.2 Authorized personnel	9	4.2.4 Mounting dimensions, 24 VDC / 90 to 264 VAC design, with control unit	20	4.6.2.1 Timer mode	32
1.3 Electric shock hazard	10	4.3 KFG (S) (L) (C) pump element series	21	4.6.2.2 Control using machine pulses (Counter mode)	34
1.4 System pressure hazard	10	4.3.1 Pump element designs	21	<b>4.6.3 KFGI series</b>	<b>36</b>
1.5 Compressed air hazard	10	4.3.2 Pump elements with spring-return pistons	22	4.6.3.1 KFGI MonoFlex single-line lubrication systems	36
1.6 Hydraulic pressure hazard	10	4.3.3 Assembly of a pump element with spring return pistons	23	4.6.3.2 KFGI ProFlex for progressive centralized lubrication systems	38
1.7 Explosion protection information	11	4.3.4 Pump elements with positively driven pistons	24	4.6.4 Connectivity of KFGI ProFlex or Monoflex 230 VAC with pressure switch or cycle switch and valve	40
<b>2. Lubricants</b>	<b>12</b>	4.3.5 Assembly of a pump element with positively driven pistons	25	<b>4.6.5 KFGC series (CAN bus)</b>	<b>41</b>
2.1 General information	12	4.3.6 Pressure regulating valve	26	4.6.5.1 KFGC ProFlex and KFGC MonoFlex	41
2.2 Selection of lubricants	12	4.4 Information on lubricant filling	27	4.6.5.2 KFGC ProFlex - rotary , for connection of 5/4 directional control valve	42
2.3 Approved lubricants	13	4.4.1 Lubricant filling	27	4.6.6 Pressure relief valve with integrated pressure regulating valve	43
2.4 Lubricants and the environment	14	4.4.2 Filler coupling	28	4.7 Fill level monitoring	44
2.5 Lubricant hazards	14	4.4.3 Filling cylinder	28	4.7.1 Fill level monitoring, Code 1	45
<b>3. Overview</b>	<b>15</b>	4.5 Electrical power supply	29	4.7.2 Fill level monitoring, Code 2	46
<b>4. Assembly</b>	<b>16</b>	4.5.1 General conditions for electrical connections	29	4.7.3 Fill level monitoring, Code 3	47
4.1 General information	16	4.5.2 Power supply 24 VDC	30	4.8 Pump unit fill level control Visual	48
4.2 Setup and attachment	16	4.5.3 Power supply 90-264 VAC	30	4.9 Lubrication line connection	48
4.2.1 Minimum clearance height for installation	17	4.6 Control port assignments	31	4.10 Lubrication line arrangement	48
4.2.2 Mounting diagram	18	<b>4.6.1 KFG series</b>	<b>31</b>	4.11 Progressive system ventilation	49
		4.6.1.2 External control units	31	4.12 Single-line system ventilation	49
				4.13 Note on the rating plate	49

# Operating instructions table of contents

<b>1. Safety instructions</b>	<b>52</b>	<b>6. Functional description in progressive systems</b>	<b>58</b>	<b>9. KFGS control unit</b>	<b>68</b>
1.1 General information	52	6.1 Functional description for progressive systems with a KFG pump unit	58	9.1 Display and control elements of control screen	68
1.2 Disclaimer of liability	52	6.1.1 Pump element	58	9.1.1 Three-digit LED display	69
<b>2. Lubricants</b>	<b>52</b>	6.1.2 Pressure regulating valve	59	9.1.2 LED display	71
<b>3. Transport, delivery, and storage</b>	<b>53</b>	6.2 Progressive system with a KFGS or KFGL pump unit	60	9.1.3 Pushbutton operation	72
3.1 Lubrication units	53	6.3 Progressive system with a KFGC (CAN bus) pump unit	61	9.2 KFGS display mode	73
3.2 Electronic and electrical devices	53	<b>7. Functional description in single-line systems</b>	<b>62</b>	9.3 KFGS programming	75
3.3 General notes	53	7.1 KFG-Pump unit	62	9.3.1 Start programming mode	75
<b>4. Assembly</b>	<b>54</b>	7.1.1 Pump element	62	9.3.2 Change lubrication interval times	75
4.1 Information on assembly	54	7.1.2 Pressure relief valve	62	9.3.3 Configure system monitoring	77
4.2 Assembly procedure for KFG (S) (L) (C) pump units	54	7.1.3 Pressure regulating valve	62	9.3.4 Change operating modes	78
<b>5. Design and function</b>	<b>54</b>	7.2 Functional description of single-line systems with KFGL-Pump unit	64	9.3.5 Change access code	79
5.1 General information	54	7.3 Functional description in single-line systems with a KFGC (CAN-Bus) pump unit	66	9.3.6 Programming ranges	80
5.2 Design	54	7.3.1 Systems with 3/2 directional solenoid valves	66	9.3.7 Display ranges	80
5.2.1 Pump housing	54	7.3.2 Multiple lubrication zones	66	9.4 KFGS operating modes	80
5.2.2 Lubricant reservoir	55	<b>8. Commissioning</b>	<b>67</b>	9.4.1 Timer operation	80
5.2.3 Fill level monitoring	55	8.1 General commissioning	67	9.4.2 Counter operation	80
5.2.4 KFGS and KFGL control units	55			9.4.3 No system monitoring	81
5.3 KFG pump units	55			9.4.4 With system monitoring	81
5.4 KFGS pump units	56			9.5 Fill level monitoring	81
5.5 KFGL pump units	56			9.5.1 Monitoring via piston detector	81
5.6 KFGC (CAN bus)	57				

<b>10. KFGL control unit</b>	<b>83</b>	<b>14. Operational and pump faults</b>	<b>97</b>	<b>15. Technical data</b>	<b>104</b>
10.1 Display and control elements of control screen	83	14.1 Operational malfunctions	97		
10.2 Display and control menu	85	14.1.1 General information	97	<b>16. Accessories</b>	<b>107</b>
10.2.1 Main menu	85	14.1.2 Malfunctions on pump units	97		
10.2.2 Info - Information mode	86	14.2 Malfunctions on KFGS pump unit	99		
10.2.3 Config. - Configuration mode	88	14.2.1 Display faults	99		
10.3 Programming a KFGL pump unit	90	14.2.2 Delete fault notification	99		
		14.2.3 Fault types	100		
<b>11. KFGC control unit</b>	<b>91</b>	14.2.4 Recording fault times	101		
11.1 KFGC series (CAN bus)	91	14.2.5 Malfunctions on KFGS pump unit with a progressive feeder system	101		
		14.3 Malfunctions KFGL pump unit	102		
<b>12. Shutdown/disposing</b>	<b>93</b>	14.3.1 Display faults	102		
12.1 Temporary shutdown	93	14.3.2 Delete fault notification	102		
12.2 Permanent shutdown	93	14.3.3 Fault types	102		
		14.3.4 Fault notifications	102		
<b>13. Maintenance and service</b>	<b>94</b>	14.3 Malfunctions KFGC pump unit	103		
13.1 General information	95	14.3.1 Faults detected by control unit	103		
13.2 Maintenance and repair	95	14.3.2 Fault types	103		
13.3 Service	95	14.3.3 Read faults	103		
		14.3.4 Remedy faults	103		

## Information concerning EC Declaration of Conformity and EC Declaration of Incorporation

The product, reservoir unit of the series:

**KFG, KFGS, KFGL, KFGC**

is hereby confirmed to comply with the essential protection requirements stipulated by the Directive(s) of the Council on the approximation of laws of the Member States concerning:

- **Machinery Directive 2006 2006/42/EG**
- **Electromagnetic Compatibility 2014/30/EU**
- **Low Voltage Devices 2014/35/EU**
- **RoHS II Directive 2011/65/EU**

### Notes:

- (a) This declaration certifies compliance with the aforementioned Directives, but does not constitute a guarantee of characteristics.
- (b) The safety instructions in the documentation included with the product must be observed.
- (c) The commissioning of the products here certified is prohibited until such time as the machine or vehicle in which the product is installed conforms with the provisions and requirements of the applicable Directives.

(d) The operation of the products at non-standard supply voltage, as well as non-adherence to the installation instructions, can negatively impact the EMC characteristics and electrical safety.

We further declare:

- The aforementioned product is, **according to EC Machinery Directive 2006/42/EC, Annex II Part B, designed for installation in machinery / for incorporation with other machinery to form a machine.** Within the scope of application of the EC Directive, commissioning shall be prohibited until the machinery in which this part is installed conforms with the provisions of this Directive.
- The aforementioned product may, with reference to EC Directive 97/23/EC concerning pressure equipment, only be used in accordance with its intended use and in conformity with the instructions provided in the documentation. The following must be observed in this regard:

The product is neither designed nor approved for use in conjunction with fluids of Group 1 (Dangerous Fluids) as defined in Article 2, Para. 2 of Directive 67/548/EEC of June 27, 1967. The product is neither designed nor approved for use in conjunction with gases, liquefied gases, pressurized gases in solution, vapors and such fluids whose vapor pressure exceeds normal atmospheric pressure (1013 mbar) by more than 0.5 bar at their maximum permissible temperature.

When used in conformity with their intended use, the products supplied by SKF Lubrication Systems Germany GmbH do not reach the limit values listed in Article 3, Para. 1, Clauses 1.1 to 1.3 and Para. 2 of Directive 97/23/EC. They are therefore not subject to the requirements of Annex 1 of the Directive. Consequently, they do not bear a CE marking in respect of Directive 97/23/EC. SKF Lubrication Systems Germany GmbH classifies them according to Article 3, Para. 3 of the Directive. The Declaration of Conformity and Incorporation forms part of the product documentation and is supplied together with the product.

## Explanation of symbols and signs

You will find these symbols, which warn of specific dangers to persons, material assets, or the environment, next to all safety instructions in these operating instructions.

Please heed these instructions and proceed with special care in such cases. Please forward all safety instructions to other users.

Instructions placed directly on the machines/ grease lubrication pump units, such as:







- Arrow indicators
- Labels for fluid connections must be followed and kept in fully legible condition.



**You are responsible!**

Please read the assembly and operating instructions thoroughly and follow the safety instructions.



### Hazard symbols

-  General hazard  
DIN 4844-2-W000
-  Electrical voltage/current  
DIN 4844-2-W008
-  Hot surface  
DIN 4844-2-W026
-  Danger of being drawn into machinery  
BGV 8A
-  Slipping hazard  
DIN 4844-2-W028
-  Warning of potentially explosive atmosphere  
DIN 4844-2-W021

### Indicators used with safety instructions and their significance

Signal word	Meaning
<b>Danger!</b>	danger of bodily injury
<b>Warning!</b>	of damage to property and the environment
<b>Note!</b>	Provides additional information

### Informational symbols

-  Note!
- Prompts an action
- Used for itemizing
- ➔ Refers to other facts, causes or consequences
-  Provides additional information

## Documentation overview

### Description/ Document number

LC502 control unit for  
ProFlex progressive centralized lubrication  
systems  
951-180-005-EN

LC502 control unit for  
MonoFlex single-line lubrication systems  
951-180-004-EN

KFG; KFGS; KFGC (CAN bus) for  
industrial use  
951-170-203-EN

CAN bus control system description  
951-130-502-EN

## 1. Safety instructions



The operator of the described product must ensure that the assembly instructions are read and understood by all persons tasked with the assembly, operation, maintenance, and repair of the product. The assembly instructions must be kept readily available.



Note that the assembly instructions form part of the product and must accompany the product if sold to a new owner.



In addition to the assembly instructions, general statutory regulations and other regulations for accident prevention and environmental protection must be observed and applied.

The described product is manufactured in accordance with the generally accepted rules and standards of industry practice and with occupational safety and accident prevention regulations. Risks may, however, arise from its usage and may result in physical harm to persons or damage to other material assets. Therefore the product may only be used in proper technical condition and in observance of the assembly instructions. In particular, any malfunctions which may affect safety must be remedied immediately.



## 1.1 Intended use

Pump units of SKF's KFG, KFGS, KFGL and KFGC series are used to supply centralized lubrication systems in vehicles, systems and machines. They deliver oils and greases (up to NLGI Grade 2).

The use of synthetic oils requires prior approval from SKF Lubrication Systems Germany GmbH.

Any other usage is deemed non-compliant with the intended use.

In particular, the described product is neither designed nor approved for use in conjunction with fluids of Group 1 (Dangerous Fluids) as defined in Article 2, Para. 2 of Directive 67/548/EC of June 27, 1967.

The product described here is neither designed nor approved for use in conjunction with gases, liquefied gases, pressurized gases in solution, vapors and such fluids whose vapor pressure exceeds normal atmospheric pressure (1013 mbar) by more than 0.5 bar at their maximum permissible temperature.

Unless specially indicated otherwise, products from SKF Lubrication Systems Germany GmbH are not approved for use in potentially explosive areas as defined in the ATEX Directive 2014/34/EU.

## 1.2 Authorized personnel

Only qualified technical personnel may install, operate, maintain, and repair the products described in the assembly instructions. Qualified technical personnel are persons who have been trained, assigned and instructed by the operator of the final product into which the described product is incorporated. Such persons are familiar with the relevant standards, rules, accident prevention regulations, and assembly conditions as a result of their training, experience, and instruction. They are authorized to identify and perform necessary actions while avoiding any risks which may arise.

The definition of qualified personnel and the prohibition against employing non-qualified personnel are laid down in DIN VDE 0105 and IEC 364.

### 1.3 Electric shock hazard

Electrical connections for the described product may only be established by qualified and trained personnel authorized to do so by the operator, and in observance of the local conditions for connections and local regulations (e.g., DIN, VDE). Significant bodily injury and property damage may result from improperly connected products.



#### **Danger!**

Work on products that have not been de-energized may result in bodily injury. Assembly, maintenance and repair work may only be performed on products that have been de-energized by qualified technical personnel. Supply voltage must be switched off before opening any of the product's components.



The protective earth conductor (PE) must always be connected. Always ensure adequate, standard conductor diameter and secure contact.



Dangerous contact voltages may occur on the unit if the protective earth conductor is not connected or is interrupted.

### 1.4 System pressure hazard



Lubrication systems are pressurized during operation. Centralized lubrication systems must therefore be depressurized before starting assembly, maintenance or repair work, or any system modifications or system repairs.

### 1.5 Compressed air hazard



The described product is pressurized during operation. The product must therefore be depressurized before starting assembly, maintenance or repair work, or any system modifications or system repairs.

Depending on the model design, the product may be able to be operated with compressed air.

### 1.6 Hydraulic pressure hazard



The described product is pressurized during operation. The product must therefore be depressurized before starting assembly, maintenance or repair work, or any system modifications or system repairs.

Depending on the model design, the product may be able to be operated hydraulically.

## 1.7 Explosion protection information



### Danger!

Only the pump models tested and approved by SKF Lubrication Systems Germany GmbH in accordance with ATEX Directive 2014/34/EU are permitted to be used in areas with explosion protection. The relevant protection class is engraved on the pump's rating plate.

- When filling lubricant into the pump, make sure the lubricant is clean. The reservoir must be filled in good time (pay attention to fill level monitoring). The pump unit may only be filled via the filler socket.
- In case of overfilling, the excessive amount of lubricant must be removed. Make sure there is no potentially explosive atmosphere when doing this.
- The switching circuits of the fill level monitor must be supplied by an intrinsically safe circuit, e.g., through the installation of an ATEX-compliant isolating switch by the customer. The unit must be grounded via a ground connection. The customer must install adequate overload protection for the power consumption of the motor.
- To avoid electrostatic discharge, lay hydraulic connecting lines in corrosion-resistant metal tubing, e.g., stainless steel pipe.
- When setting up the pump, make sure the setup location is level and not subject to vibrations or jolts.
- During maintenance work, use only tools intended for use in potentially explosive spaces or else make certain that there is no potentially explosive atmosphere present.
- The service life of the pump units is limited. It must therefore undergo a function and leak test at regular intervals. Perform appropriate repairs in the event of malfunctions, leaks, or rust. Replace the pump if necessary.
- The user must make sure through the choice of the lubricant to be delivered that no chemical reactions capable of serving as ignition sources will occur in conjunction with the explosive atmospheres expected. The lubricant's ignition temperature has to be at least 50 kelvin above the pump's maximum surface temperature (temperature class).

Depending on the model design, the product may be available in an explosion-proof design.

## 2. Lubricants

### 2.1 General information



All products from SKF Lubrication Systems Germany GmbH may be used only for their intended purpose and in accordance with the information in the product's assembly instructions.

Intended use is the use of the products for the purpose of providing centralized lubrication/lubrication of bearings and friction points using lubricants within the physical usage limits which can be found in the documentation for the devices, e.g., assembly instructions/operating instructions and the product descriptions, e.g., technical drawings and catalogs. Particular attention is called to the fact that hazardous materials of any kind, especially the materials classified as hazardous by EC Directive 67/548/EEC, Article 2, Para. 2, may only be filled into SKF centralized lubrication systems and components and delivered and/or distributed with the same after consultation with and written approval from SKF Lubrication Systems Germany GmbH.

No products manufactured by SKF Lubrication Systems Germany GmbH are approved for use in conjunction with gases, liquefied gases, pressurized gases in solution, vapors, or such fluids whose vapor pressure exceeds normal atmospheric pressure (1013 mbar) by more than 0.5 bar at their maximum permissible temperature.

Other media which are neither lubricant nor hazardous substance may only be fed after consultation with and written approval from SKF Lubrication Systems Germany GmbH. SKF Lubrication Systems Germany GmbH considers lubricants to be a component of the system design which must be factored into the selection of components and the design of centralized lubrication systems. The lubricating properties of the lubricants are critically important in these considerations.

### 2.2 Selection of lubricants



Observe the instructions from the machine manufacturer regarding the lubricants that are to be used.



#### **Warning!**

The amount of lubricant required at a lubrication point is specified by the bearing or machine manufacturer. It must be ensured that the required quantity of lubricant is provided to the lubrication point. The lubrication point may otherwise not receive adequate lubrication, which can lead to damage and failure of the bearing.

Selection of a lubricant suitable for the lubrication task is made by the machine/system manufacturer and/or the operator of the machine/system in cooperation with the lubricant supplier.

The bearings/friction points that require lubrication, their expected load during operation, and the expected ambient conditions are taken into account during selection, with consideration of economic and environmental aspects.



SKF Lubrication Systems Germany GmbH supports customers in the selection of suitable components for feeding the selected lubricant and in the planning and design of a centralized lubrication system.

Please contact SKF Lubrication Systems Germany GmbH if you have further questions regarding lubricants. Lubricants can be tested in the company's laboratory for their suitability for pumping in centralized lubrication systems (e.g., "bleeding").

You can request an overview of the lubricant tests offered by SKF Lubrication Systems Germany GmbH from the company's Service department.

### 2.3 Approved lubricants



#### **Warning!**

Only lubricants approved for the product may be used. Unsuitable lubricants can lead to failure of the product and to property damage.



#### **Warning!**

Different lubricants cannot be mixed, as mixing may result in damage and necessitate costly and complicated cleaning of the product/lubrication system. It is recommended that an indication of the lubricant in use be attached to the lubricant reservoir in order to prevent accidental mixing of lubricants.

The product described here can be operated using lubricants that meet the specifications in the technical data.

Note that in rare cases, there may be lubricants whose properties are within permissible limit values but whose other characteristics render them unsuitable for use in centralized lubrication systems. For example, synthetic lubricants may be incompatible with elastomers.

## 2.4 Lubricants and the environment



### Warning!

Lubricants can contaminate soil and bodies of water. Lubricants must be properly used and disposed of. Observe the local regulations and laws regarding the disposal of lubricants.

It is important to note that lubricants are environmentally hazardous, flammable substances which require special precautionary measures during transport, storage, and processing. Consult the safety data sheet from the lubricant manufacturer for information regarding transport, storage, processing, and environmental hazards of the lubricant that will be used.

The safety data sheet for a lubricant can be requested from the lubricant manufacturer.

## 2.5 Lubricant hazards



### Danger!

Centralized lubrication systems must always be free of leaks. Leaking lubricant is hazardous due to the risk of slipping and injury. Be mindful of any lubricant leaking out during assembly, operation, maintenance, and repair of centralized lubrication systems. Leaks must be sealed off without delay.

Lubricant leaking from centralized lubrication systems is a serious hazard. Leaking lubricant can create risks that may result in physical harm to persons or damage to other material assets.



Follow the safety instructions on the lubricant's safety data sheet.

Lubricants are a hazardous substance. The safety instructions on the lubricant's safety data sheet must be followed. The safety data sheet for a lubricant can be requested from the lubricant manufacturer.

### 3. Overview

		Unit components
Pos.	Description	Chapter
1	Assembly holes	4.2.2-4.2.4
2	Lubricant reservoir	4.2.3-4.2.4
3	Fill level monitoring	4.7-4.8
4	Lubricant filling	(4.4) 4.4.3
5	Pump element	4.3-4.3.5
6	Pressure regulating valve	4.3.6
7	Electrical connection	4.5-4.5.3
8	Control port assignments	4.6-4.7.3
9	KFGS control unit	OI Chapter 9
10	KFGL control unit	OI Chapter 10
11	KFGC control unit	OI Chapter 11
12	Shutdown	OI Chapter 12
13	Maintenance	OI Chapter 13
14	Operational and pump faults	OI Chapter 14
15	Technical data	OI Chapter 15



KFG | KFGS | KFGL | KFGC

OI = Operating instructions

## 4. Assembly

### 4.1 General information

Pump units of the KFG series are an integral component of centralized lubrication systems used in machines and systems.

They deliver greases up to NLGI Grade 2. The pump units differ in terms of the size of lubricant reservoir, the lubricant filling and their control and function monitoring. The installation of volume-specific pump elements permits a single unit of the KFG, KFGS or KFGL series to operate up to three independent zones.

The KFGC series is capable of operating up to four independent zones, depending on the task. The system can be equipped with or without functionality to monitor pressure build-up and reduction.

Before assembling/setting up the reservoir unit, the packaging material and any shipping braces (e.g., plugs) must be removed. The packaging material must be preserved until any discrepancies are resolved.

### 4.2 Setup and attachment

The pump unit should be installed in a place protected from contamination, water splashes and vibrations. It should, however, be easily accessible so that all other installations can be performed without difficulty and the device can be filled easily.

The fill level of the reservoir must be easily visible.

The unit mounting position is vertical.

Any assembly holes must be made according to the diagram on the following page.

Design specifications and conditions of the manufacturer and the object must be observed when installing the pump unit.

A drilling jig can be ordered (order number 951-130-115).

During assembly and especially when drilling, always pay attention to the following:

- Existing supply lines must not be damaged by assembly work.
- Other units must not be damaged by assembly work.
- The product must not be installed within range of moving parts.
- The product must be installed at an adequate distance from sources of heat.
- Maintain safety clearances and comply with local regulations for assembly and accident prevention.





**Warning!**

On the pump units' electrical connections, ensure that appropriate measures prevent interference between signals due to inductive, capacitive or electromagnetic couplings.

Shielded cables must be used in places where electrical interference fields can distort signal transmissions despite separate laying of cables.

The rules and empirical values for "EMC-compliant" cabling must be taken into consideration.



**Warning!**

When drilling the assembly holes, you must be careful of any supply lines or other units, as well as of other hazards such as moving parts.

Maintain safety clearances and comply with local regulations for assembly and accident prevention.



**Warning!**

Do not tilt or drop the KFG (S) (L) (C) grease lubrication pump unit!

Install the pump units on the machine using three (2kg/6kg), four (10 kg), or six (15 kg/20 kg) M8 screws with a minimum length of 20 mm.

Fastening material to be provided by the customer:

- Hexagon head screws (3x, 4x or 6x) per DIN933-M8x...-8.8
- Washers (3x, 4x or 6x) per DIN 125-B8.4-St



**Warning!**

The torque of the fastening screws depends on the customer's installation. Make sure that torque is adequate when installing the pump unit!

**4.2.1 Minimum clearance height for installation**

The minimum clearance height for installation depends on the reservoir design.

To ensure enough space for maintenance work and for any disassembly of the pump unit, add at least 20 mm additional clearance onto the total height of the pump (minimum clearance height for installation).

Minimum clearance height for installation		
Pump Size	24 VDC without control unit [mm]	24 VDC /230 VAC with control unit [mm]
2 kg	250	301
6 kg	363	415
10 kg	735	785
15 kg	960	1010
20 kg	1140	1190

-see drawings Fig. 2 and Fig. 3

KFG | KFGS | KFGI | KFGC

## 4.2.2 Mounting diagram

Mounting diagram, Fig. 1

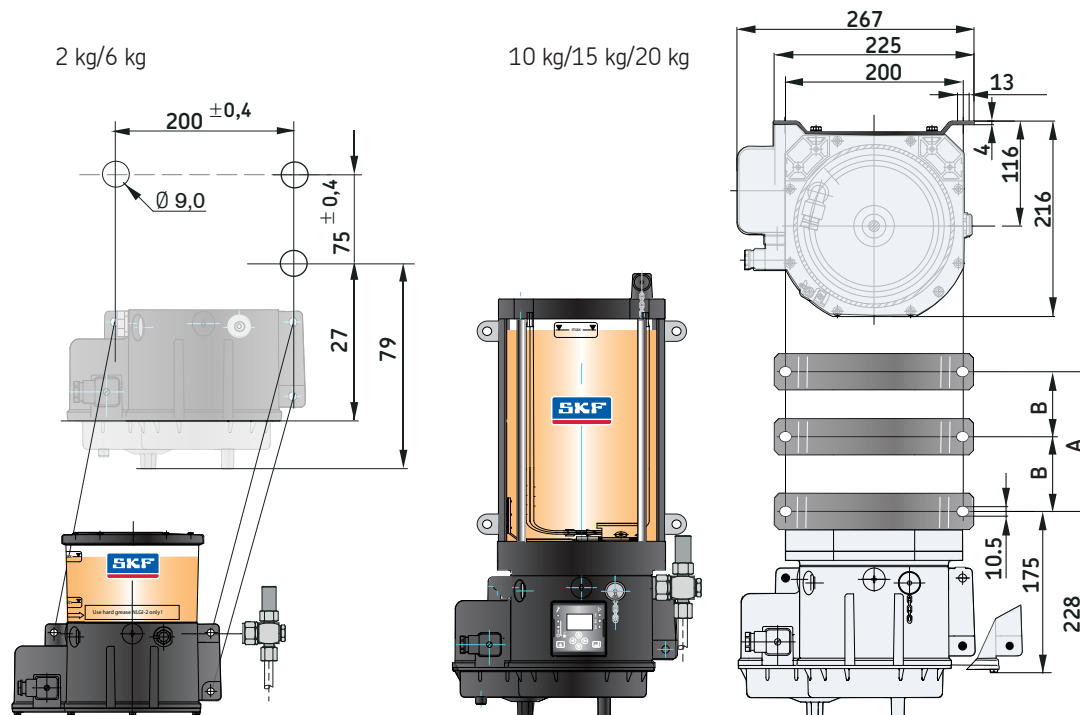

Mounting diagram

Pump size	Dim. A [mm]	Dim.B [mm]
10 kg	460	
15 kg		342.5
20 kg		432.5

### 4.2.3 Mounting dimensions, 24 V DC design, without control unit

Assembly dimensions, Fig. 2

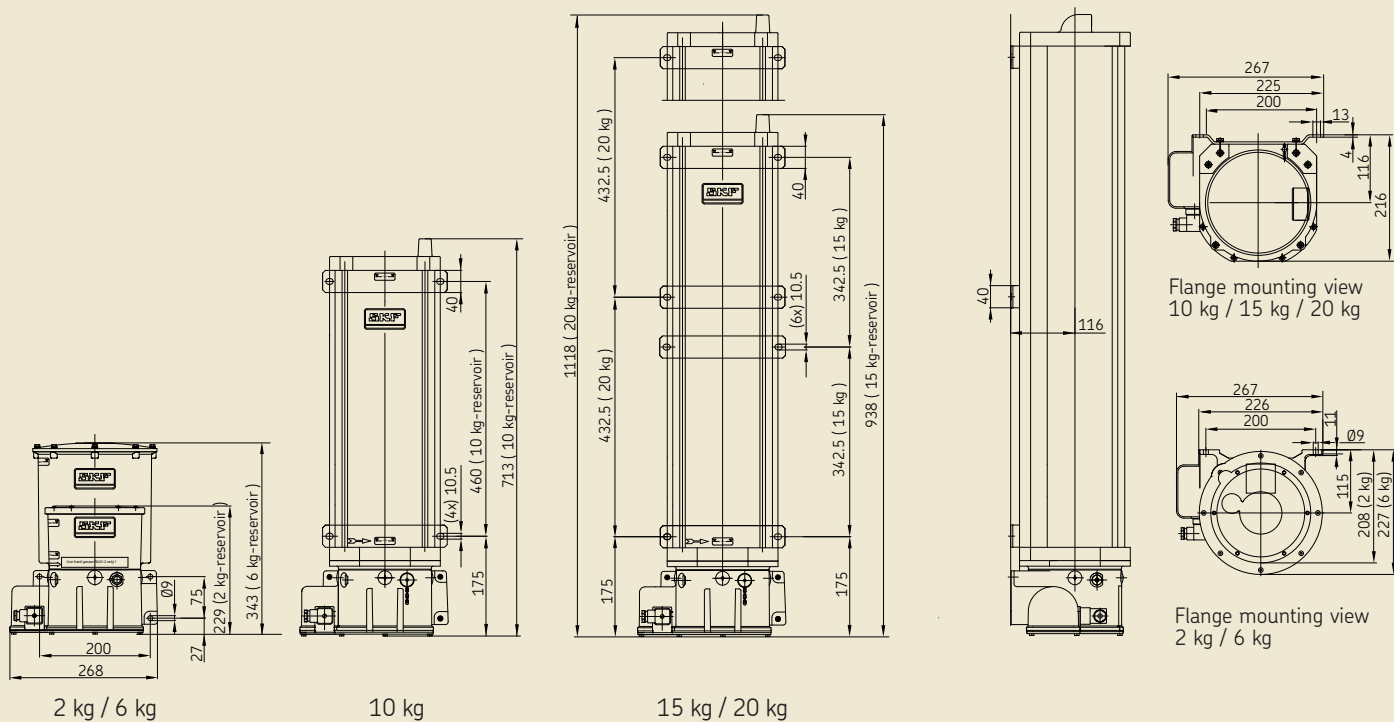

## 4.2.4 Mounting dimensions, 24 V DC and 90 to 264 V AC design, with control unit

Assembly dimensions, Fig. 3

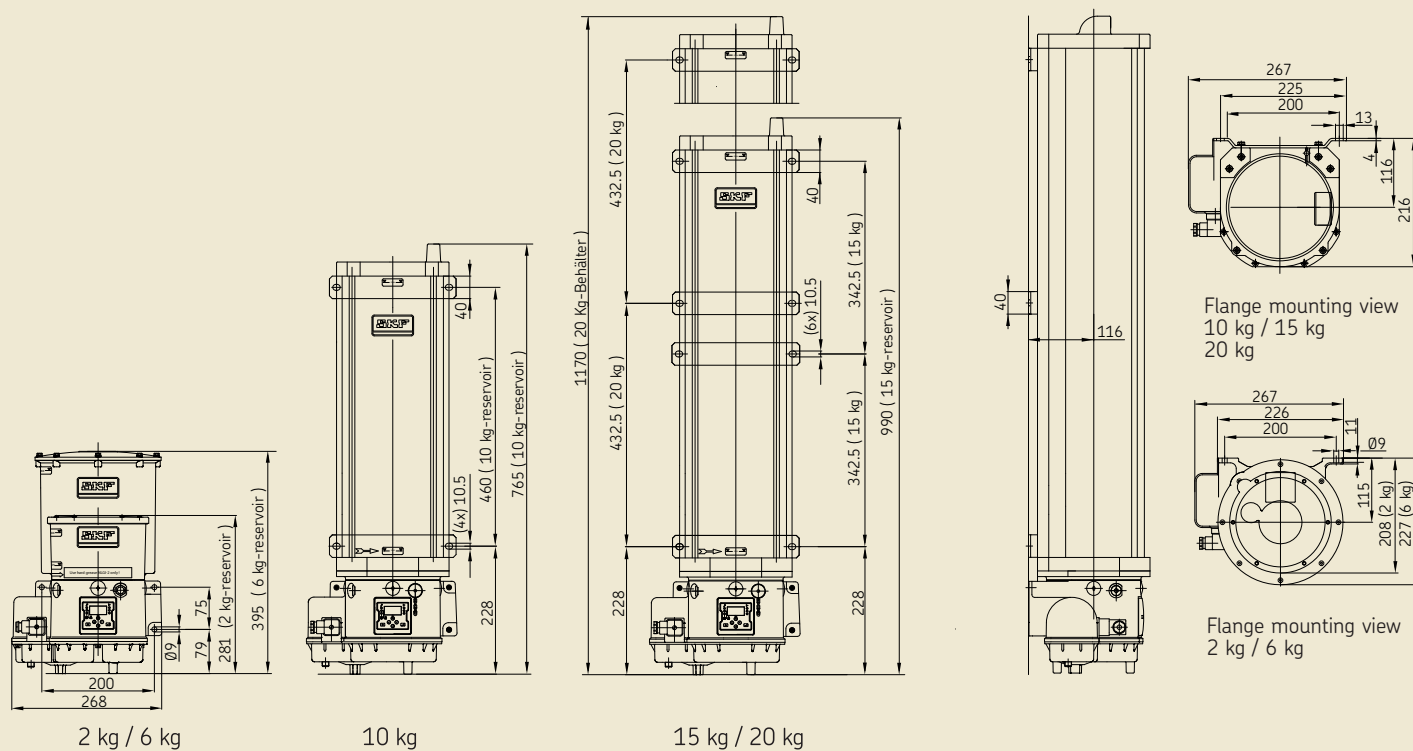

### 4.3 KFG (S) (L) (C) pump element series

KFG pump units can be equipped with up to three pump elements.

Depending on the pump unit's application (ProFlex/MonoFlex) and configuration (KFG/KFGS/KFGL/KFGC), it is possible to connect each of the pump elements to a single, independent lubrication zone and/or to link them together to form a shared zone.

The pump elements are available in two types of design: with spring return pistons or positively driven pistons.

In both types, the pistons are actuated by a cam disc. In the spring return design, the piston of the pump element is pressed against the cam disc by a spring. In the positively driven design, on the other hand, the piston of the pump element is slotted into the cam disc, which is especially practical when the unit is used at very low temperatures.

The pump elements are available in different models for different delivery rates.

A grease return or a filler socket can be attached in place of a pump element.

A screw plug (DIN 910-M20x1.5-5.8) with sealing ring (DIN 7603-A20x24-AI) can also be fitted if desired. Alternatively the screw plug can be ordered from SKF under order number KFG 1.128.

#### 4.3.1 Pump element designs

Pump units of the KFG series are generally delivered with pump elements installed. Perform the following to later add or replace a pump element:

Layout of the pump elements, Fig. 4

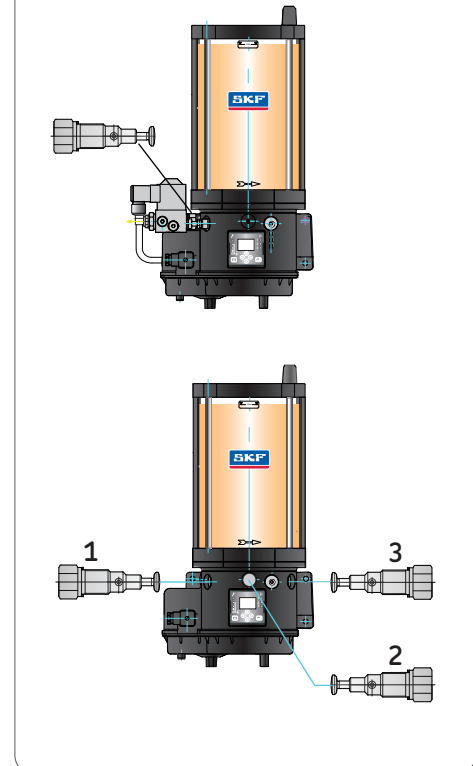

When ordering pump elements, the required delivery rate must be specified, as well as the design type (spring return pistons/ positively driven pistons).



### Warning!

The two types of pump element, with spring return pistons and positively driven pistons, are not interchangeable!

Connection of the pump elements, Fig. 5

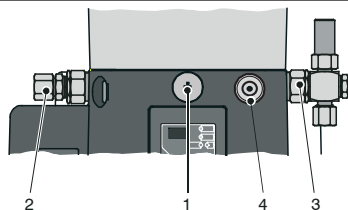

Connection for pump elements

- 1 Screw plug
- 2 Pipe connector
- 3 Pump element with pressure regulating valve
- 4 Lubricant nipple /filler socket

## 4.3.2 Pump elements with spring-return pistons

Pump elements with spring-return pistons

Delivery rate <sup>1)</sup> [cm <sup>3</sup> /min]	Number of grooves	Max. perm. oper. pressure [bar]	Order No.
5.0	0	200	KFG1.U0
2.5	1	300	KFG1.U1
1.8	2	300	KFG1.U2
1.3	3	300	KFG1.U3
0.8	4	300	KFG1.U4

1) The values given here apply for a temperature of 20 °C, back pressure of 50 bar and greases of NLGI Grade 2.

Spring-return pump element KFG1.U1 without pressure regulating valve, Fig. 6

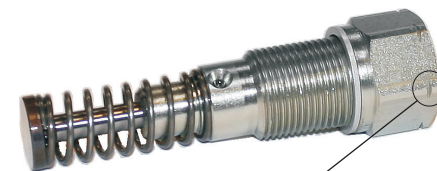
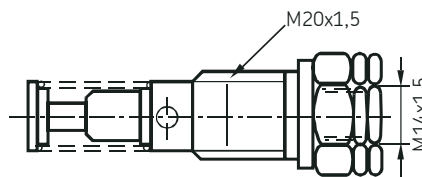

Marking grooves, see table, column for number of grooves

Optional pump element outlet G 1/4 "

### 4.3.3 Assembly of a pump element with spring return pistons

- Turn off pump unit.
- Unscrew and remove screw plug (KFG1.128)

#### Then perform the following:

- Loosen and remove pressure regulating valve (2) (or lubrication line (3)) on an already mounted pump element (1).
- Loosen and remove mounted pump element (1).
- Insert new pump element (1) into housing hole and twist in by hand.
- Tighten pump element (1) at a torque of 35 Nm.
- Switch on pump and leave running until grease without bubbles discharges from the pump element outlet.
- Reconnect pressure regulating valve (2) (or lubrication line (3)) to the pump element (1) and tighten at a torque of 25 Nm.

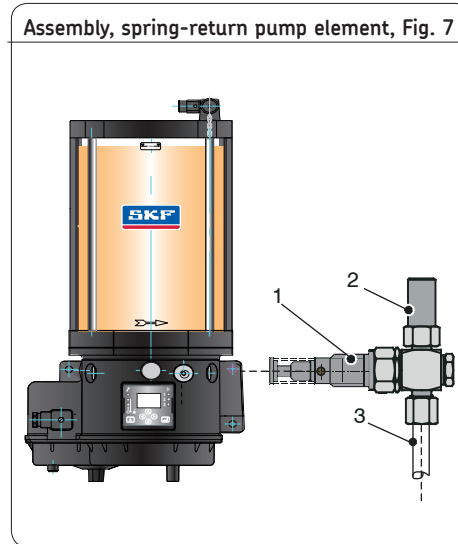

### 4.3.4 Pump elements with positively driven pistons

Pump elements with positively driven pistons

Delivery rate <sup>1)</sup> [cm <sup>3</sup> /min]	Max. permiss. oper. pressure [bar]	Labeling	Order No.
5.0	250	L-0	KFG1.U0-E
2.5	350	G-1	KFG1.U1-E
1.8	350	H-2	KFG1.U2-E
1.3	350	J-3	KFG1.U3-E

1) The values given here apply for a temperature of 20 °C, back pressure of 50 bar and greases of NLGI Grade 2.

Positively driven pump elements G-1 without pressure regulating valve, Fig. 8

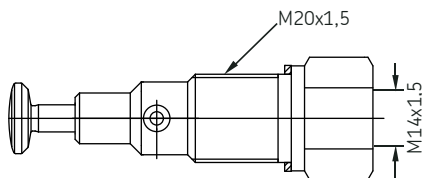

Optional pump element outlet G 1/4 " "



Labeling,  
see table, labeling column.

### 4.3.5 Assembly of a pump element with positively driven pistons

see Fig. 9

- Turn off pump unit.
- Unscrew and remove screw plug (KFG1.128)

#### Then perform the following:

- Loosen and remove pressure regulating valve (2) (or lubrication line (3)) on an already mounted pump element (1).
- Switch off the pump unit as soon as the pump element to be changed (1) begins pumping. (To position the eccentric ring).
- **Section A** Disengage the installed pump element (1) and slowly unscrew it out
- **Section B** After the final turn of the screw thread, slightly raise the pump element (1) so that the piston comes out of the eccentric ring (4)
- Carefully pull the pump element (1) out of the housing bore (5), making sure that the piston (6) is not pulled out of the pump element
- ☞ If the piston does come loose while pulling out the pump element, remove it from the housing bore with a bar magnet (or taper-nose pliers).



- **Section C** Carefully pull the piston (6) out of the new pump element (1)
- Coat the bore of the pump element lightly with grease
- Insert the piston in the bore of the pump element, leaving as much of the piston as possible protruding from the bore
- **Section D** Slowly insert the pump element (1) at an angle into the housing bore (5) until the piston bottoms out under the guide of the eccentric ring (4)
- Straighten the pump element (1) horizontally and screw it into the housing bore (5) by hand
- Tighten pump element (1) at a **torque of 35 Nm.**
- Switch on pump and leave running until grease without bubbles discharges from the pump element outlet.
- Connect pressure regulating valve (2) or lubrication line (3) to the pump element (1) and tighten at a **torque of 25 Nm**

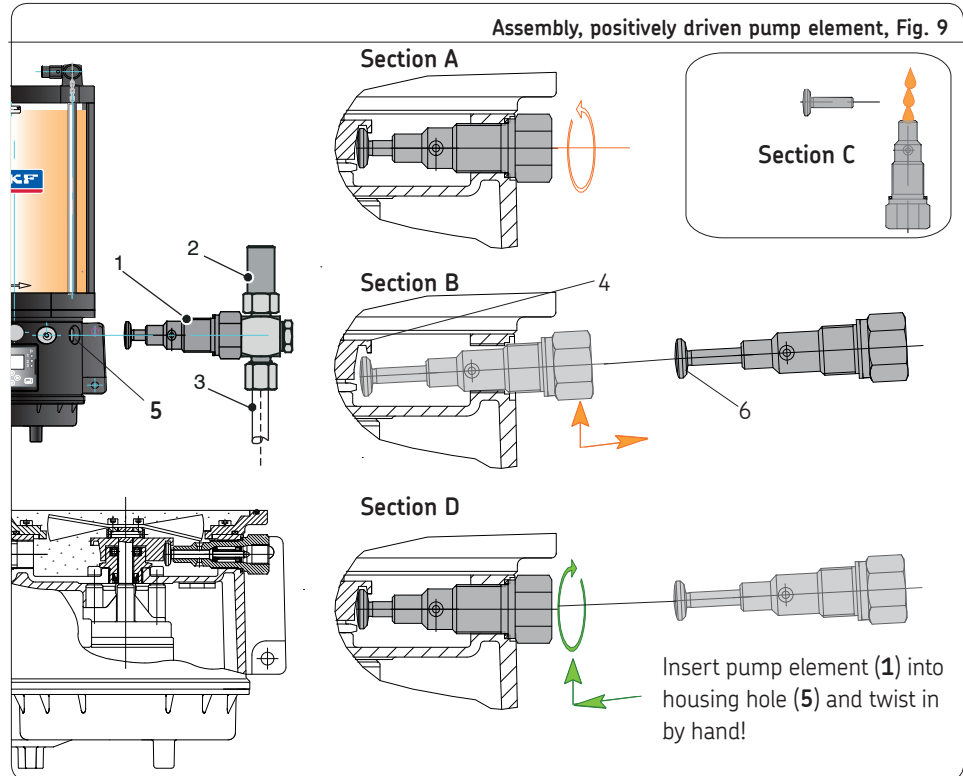

### 4.3.6 Pressure regulating valve

A pressure regulating valve (1) protects the entire lubrication system against excessive system pressure. It is mounted directly on the pump element (2). The cracking pressure set for this valve is 300 bar or 200 bar, depending on the valve design. If a blocked feeder or a lubrication point causes operating pressure to rise above 300 (200) bar, the valve opens, followed by a noticeable discharge of grease (3). This protects the pump unit against damage. At the same time, it functions as a way of visually monitoring the system. A further option are pressure regulating valves with an emergency lubricant nipple. These can be actuated manually to provide the lubrication system with adequate lubricant in case of power failure or a defective pump.

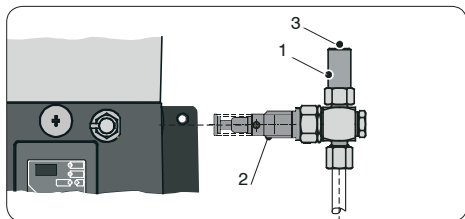

Connection for pressure regulating valve

#### Pressure regulating valve

##### Pressure regulating valve without lubricant nipple

Tube Ø [mm]	Cracking pressure [bar]	Order number
6	300	<b>161-210-012</b>
6	200	<b>161-210-049</b>
8	300	<b>161-210-018</b>
8	200	<b>161-210-050</b>
10	300	<b>161-210-035</b>
10	200	<b>161-210-051</b>
G 1/4	300	<b>161-210-036</b>
G 1/4	200	<b>161-210-059</b>

##### Pressure regulating valve with lubricant nipple

6	300	<b>161-210-014</b>
8	300	<b>161-210-025</b>

##### Pressure regulating valve with pressure gauge

6	300	<b>161-210-046</b>
8	300	<b>161-210-047</b>
10	300	<b>161-210-048</b>

#### Pressure regulating valve, Fig. 10

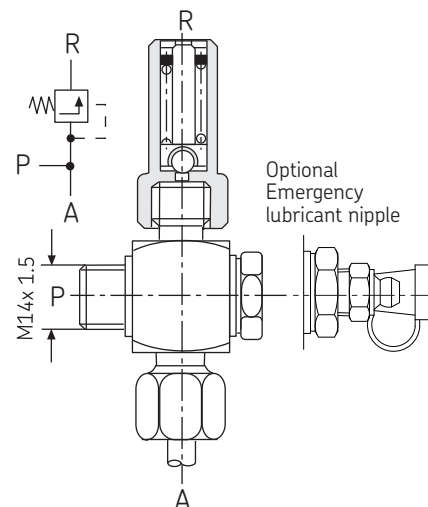

#### Connections for pressure regulating valves

- A** Connection for pipe Ø
- P** Pipe thread for pump element
- R** Grease discharge at overpressure

Cracking pressure 300 ± 20 bar  
Cracking pressure 200 ± 20 bar

Pressure regulating valve		
Pressure regulating valve with T connector output		
Tube Ø [mm]	Cracking pressure [bar]	Order number
6	300	<b>161-210-038</b>
6	200	<b>161-210-032</b>
8	300	<b>161-210-039</b>
8	200	<b>161-210-031</b>
10	300	<b>161-210-016</b>
10	200	<b>161-210-030</b>

#### 4.4 Information on lubricant filling



Only fill using clean lubricant and an appropriate filling device. Contaminated lubricants can result in severe system malfunction.

##### 4.4.1 Lubricant filling

The lubricant is filled on the housing via a lubricant nipple (1).

Lubricant can alternatively be filled via a filler coupling (see section 4.4.2).

When used at very low temperatures, the lubricant can optionally be filled via a filler socket (see section 4.4.3), which is likewise mounted on the reservoir housing. When filling in this way, make sure that air pockets do not form in the lubricant in the pump reservoir during the filling process.

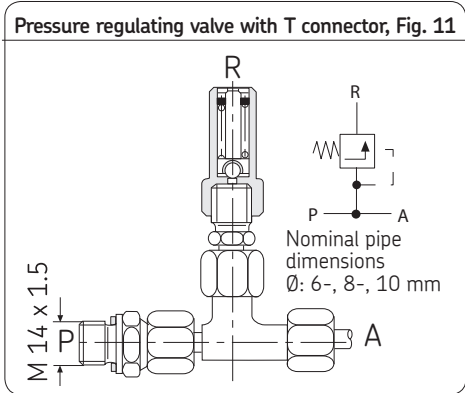

Filling, Fig. 12

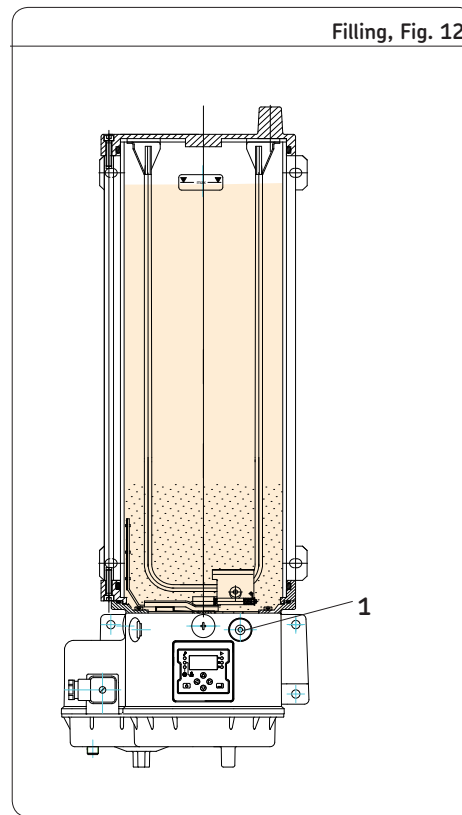

#### 4.4.2 Filler coupling

As an alternative or in addition to the conical head nipple (1) the unit can also be fitted with a filler socket (part No. 995-000-705) (2) for filling by means of a filler pump. A corresponding coupling socket (part No. 995-001-500) (3) must be mounted on the filling pump. The cap on the filler socket must be removed before filling.

#### 4.4.3 Filling cylinder

When used at very low temperatures, the pump unit can optionally be filled via one of the lubricant outlets using a filling cylinder (1). This is done by removing the screw plug M20 x1.5 (2) from the lubricant outlet and replacing it with a filler socket (part No. 169-000-174) (3). When filling, the caps (4) need to be removed from the socket and the filling cylinder.

Filling via filler coupling 13

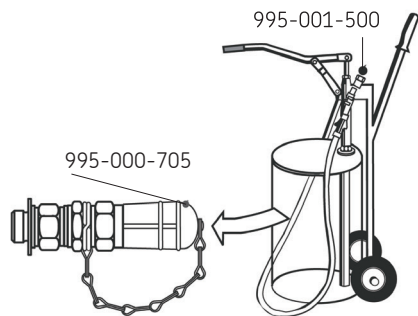

Filling via filling cylinder 14

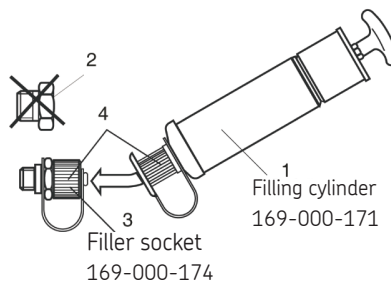

## 4.5 Electrical power supply

### Warning!



Compare the operating voltage with the specifications on the rating plate.

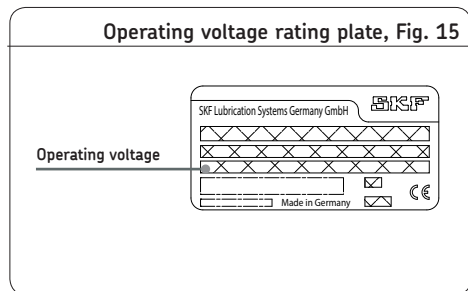

The KFG pump units are available in the voltage designs 24 VDC, 90-264 VAC and 120-370 VDC.

The electrical voltage connection is established through a 4-pin cable socket according to DIN EN 175301-803.

## 4.5.1 General conditions for electrical connections

### KFG; KFGS; KFGL; KFGC, General conditions for electrical connections

Rated voltage	Power consumption (load-dependent)	Power consumption (max.)	Pump starting current (ca. 20 ms)	Max. back-up fuse
24 VDC <sup>1)</sup>	1.25 A <sup>2)</sup>	< 2.5 A	4.5 A	4 AT <sup>3)</sup>
115 VAC	K.A. <sup>4)</sup>	1.5 A	20 A	C6A <sup>5)</sup>
230 VAC	K.A. <sup>4)</sup>	0.9 A	40 A	C6A <sup>5)</sup>

  

### KFGC (CAN bus)

Switching outputs:	Type: Solid-state output, short-circuit-proof and overload-proof
Max. current-carrying capacity:	- with simultaneous operation of 4 outputs 1.0 A - with simultaneous operation of 2 outputs 1.25 A - with operation of 1 output 1.5 A
Modes of operation:	- Single operation - Parallel connection of multiple outputs while simultaneously increasing output current
Signal inputs:	Type: digital solid-state input, short-circuit-proof
Connectivity:	- Switching contact, no detection of wire breakage - Dual wire sensors (e.g., piston detector), detection of wire breakage

- 1) Protective measures that must be applied for designated usage: **"Functional Extra Low Voltage"**, **"Protective Extra Low Voltage" (PELV)**  
Standards: EN 60204 Part 1: IEC 60204-1: DIN VDE 0100 Part 410 / IEC 364-4-41: HD384.4.41
- 2) Typical value at ambient temperature = 25 °C and operating pressure = 150 bar
- 3) Conductor: cross-section 1.5 mm<sup>2</sup>, length ≤ 12 m
- 4) No specification
- 5) Circuit breaker which characteristic „C“

## 4.5.2 Power supply 24 VDC

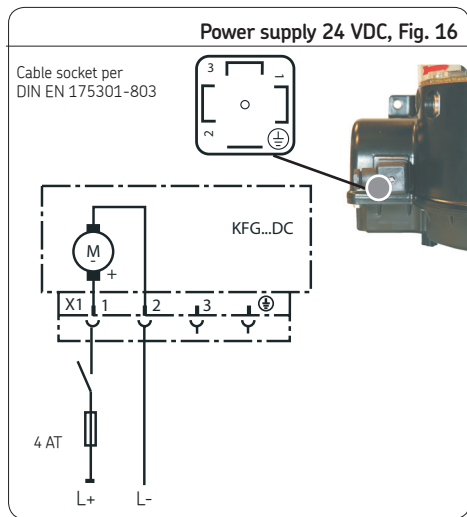

## Connector pin assignment for 24 VDC

PIN	Description
1	<b>+</b> (Power) = <b>L+</b> Supply voltage potential (Main machine switch ON)
2	<b>-</b> (Ground) = <b>L-</b> Supply voltage potential (0 V, GND)

## 4.5.3 Power supply 90-264 VAC

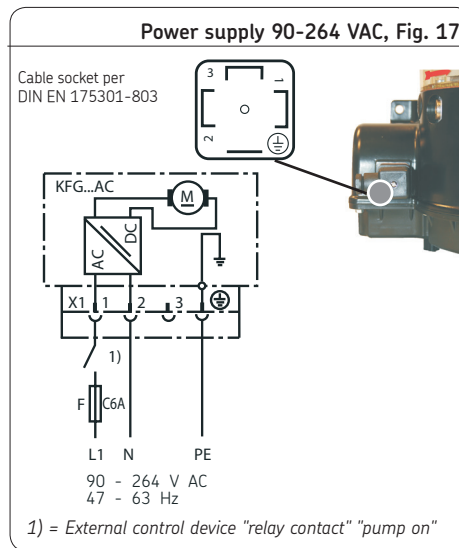

## Connector pin assignment 90-264 VAC

PIN	Description
1	<b>L1</b> Main machine switch ON
2	<b>N</b>
3	Plug without internal connection <b>PE</b> protective (earth) conductor

## 4.6 Control port assignments

### 4.6.1 KFG series

#### 4.6.1.2 External control unit



The external control units listed in Chapter 16 are designed to control the lubrication and interval times, as well as to monitor the lubrication process.



The operating instructions/functional description of the corresponding control unit must be observed.

### 4.6.2 KFGS series

With integrated IG502 control unit  
The KFGS pump unit is available in the voltage designs 24 VDC, 90-264 VAC and 120-370 VDC.

Depending on the lubrication system, the pump control unit can run in the following control modes:

- Timer operation without system monitoring
- Timer operation with system monitoring
- Counter operation without system monitoring
- Counter operation with system monitoring

Depending on the pump unit design, an additional plug for fill level control can be integrated into the pump housing,  
The standard connections are presented below.



You can find technical data and the order number of the M12x1circular connector (mating part for circular plug socket) required by the customer in brochure No. 1-1730, "Electric Plug-and-Socket Connectors."



The "Timer operation with system monitoring and fill level control" connectivity option (Chapter 4.5.2.1) is also available in an advanced version with a piston detector and fault signal. A T connector (Order No. 179-990-700) with a special cable adapter is required for this.

You can find this, along with an illustration of the connection, under Accessories, Chapter 16.



Unneeded conductor ends on the cable set must be individually insulated and secured so that no short to ground can occur.

### 4.6.2.1 Timer mode

#### Timer mode

In timer mode, the interval time is determined by a time value. It is configured by entering a time value in hours.

The pump cycle time is configured using a time value in minutes.

The fill level monitoring switch (order code 1 (W1) or order code 2 (W1G)) is connected internally to the integrated pump control system. In the case of a fill level control switch with order code 3 (W2), the fill level is monitored via a connection provided by the customer. A fault notification can be sent to the process control level via indicator light SL2.

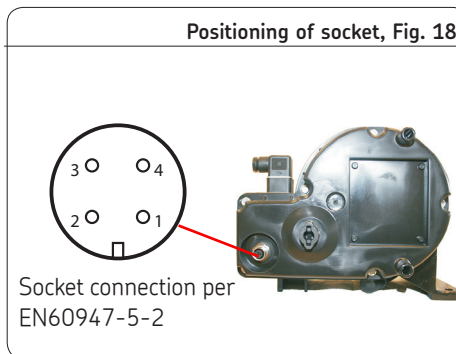

#### Socket pin assignment

PIN	Color code	Conductor coloring
1	BN	Brown
2	WH	White
3	BU	Blue
4	BK	Black

#### Connectivity

#### Timer operation without system monitoring

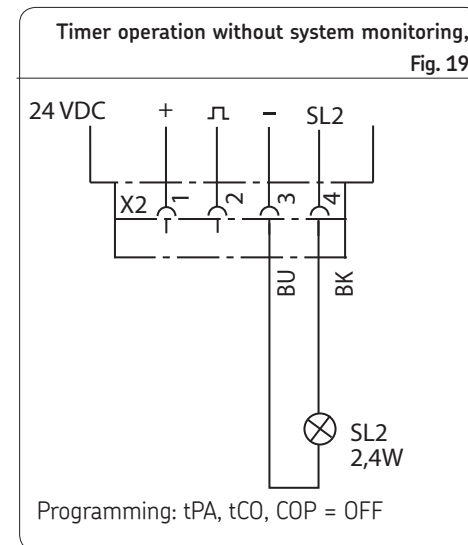

#### Connector pin assignment in timer operation

PIN	Code	Assignment
3	SL2	"Fault" indicator light (-)
4	SL2	"Fault" indicator light (+)



### Connectivity Timer operation with system monitoring

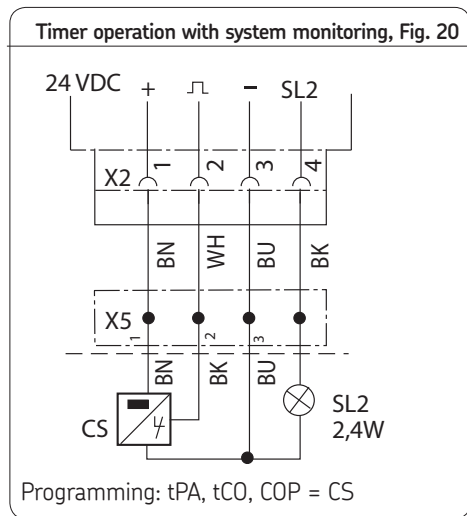

### Connectivity: Timer operation with system monitoring, fill level control, piston detector and indicator light.

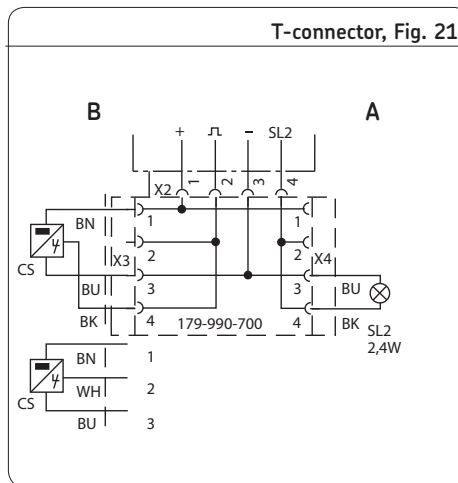

Connection for fault notification SL2		
PIN	Code	Assignment
1	-	
2	-	
3	SL2	Fault indicator light (-)
4	SL2	Fault indicator light (+)
Connection for piston detector CS		
PIN	Code	Assignment
1		Voltage (+)
2	CS	Piston detector (signal (-))
3		
4	CS	Piston detector (signal (+))

**Connector pin assignment in timer operation**

PIN	Code	Assignment
1		Voltage (+)
2	CS	Piston detector (signal)
3	SL2	"Fault" indicator light (-)
4	SL2	"Fault" indicator light (+)

**Accessories**

Description	Order No.
<b>Cable set</b> M12x1 circular connector with cable (5 m)	<b>179-990-719</b>
<b>Two-way distributor</b> for connecting to the M12x1 plug on the pump with 2x M12x1 outputs for piston detector and separate indicator lamp)	<b>179-990-700</b>

#### 4.6.2.2 Control using machine pulses (Counter mode)

##### Control using machine pulses (load-dependent lubrication)

The duration of the interval time is determined by a pulse generator that sends pulses to the control unit based on how long the machine has been running. The control unit counts the pulses that are received and starts the pump after the pre-set number of pulses.

The pump cycle time is defined by a time value. Both the number of pulses that determine the interval time and the pump cycle time can be configured.

A fault notification can be sent to the process control level via indicator light SL2.

**!** One pulse is counted each time the operating voltage is switched on when the machine contact is closed in counter operation.

Positioning of socket, Fig. 22

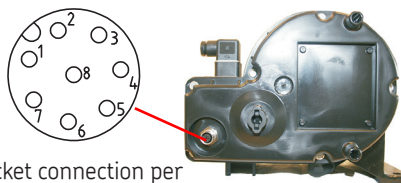

Socket connection per  
EN60947-5-2

##### Socket pin assignment

PIN	Color code	Conductor coloring
1	WH	White
2	BN	Brown
3	GN	Green
4	YE	Yellow
5	GY	Grey
6	PK	Pink
7	BU	Blue
8	RD	Red

### Connectivity Counter operation without system monitoring

**Counter operation without system monitoring, Fig. 23**

The interval depends on the number of pulses. The pump cycle time is time-dependent.

**Programming:**  
cPA, tCO, COP = OFF - see Chapter 9.4.3 of the operating instructions

**Connector pin assignment without system monitoring**

PIN	Code	Assignment
1-4		Not assigned
5	<b>MK/DK</b>	Machine contact/pressure contact
6	<b>MK/DK</b>	Machine contact/pressure contact
7	<b>SL2</b>	"Fault" indicator light ( - )
8	<b>SL2</b>	"Fault" indicator light ( + )

**Accessories**

Description	Order No.
Connecting cable, M12 connector with self-locking screw closure and molded PUR cable	
10 m length	179-990-849

### Connectivity Counter operation with system monitoring

**Counter operation with system monitoring, Fig. 24**

Programming: cPA, tCO, COP = CS

**Connector pin assignment with system monitoring**

PIN	Code	Assignment
1	<b>MK/DK</b>	Cycle switch/pressure contact
2	<b>MK/DK</b>	Cycle switch/pressure contact
3-4		Not assigned
5	<b>MK/DK</b>	Machine contact/pressure contact
6	<b>MK/DK</b>	Machine contact/pressure contact
7	<b>SL2</b>	"Fault" indicator light ( - )
8	<b>SL2</b>	"Fault" indicator light ( + )

### 4.6.3 KFGL series

With integrated LC502 control unit

The KFGL pump unit is available in the voltage designs 24 VDC, 90-264 VAC and 120-370 VDC.

The KFGL pump unit can be fitted with a fill level switch of one of the following types for indication of the “Minimum” fill level:

- Order code 1 (formerly W1 control) for greases of NLGI  $\geq 2$
- Order code 2 (formerly W1G control) with signal smoothing, for greases of NLGI  $\geq 2$
- Order code 3 (formerly W2 control) for greases of NLGI  $\leq 1$

The fill level switch in question is connected internally to the pump control system. The standard connections are presented below.

#### 4.6.3.1 KFGL MonoFlex single-line lubrication systems

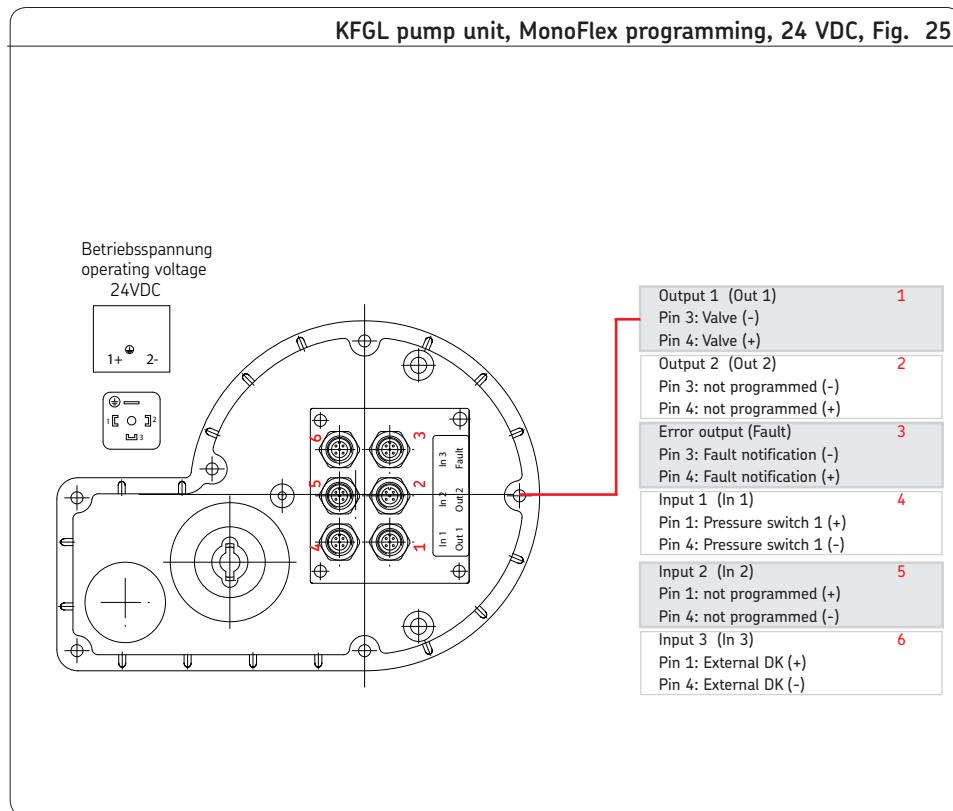

KFGL pump unit, MonoFlex programming, 230 VAC, Fig. 26

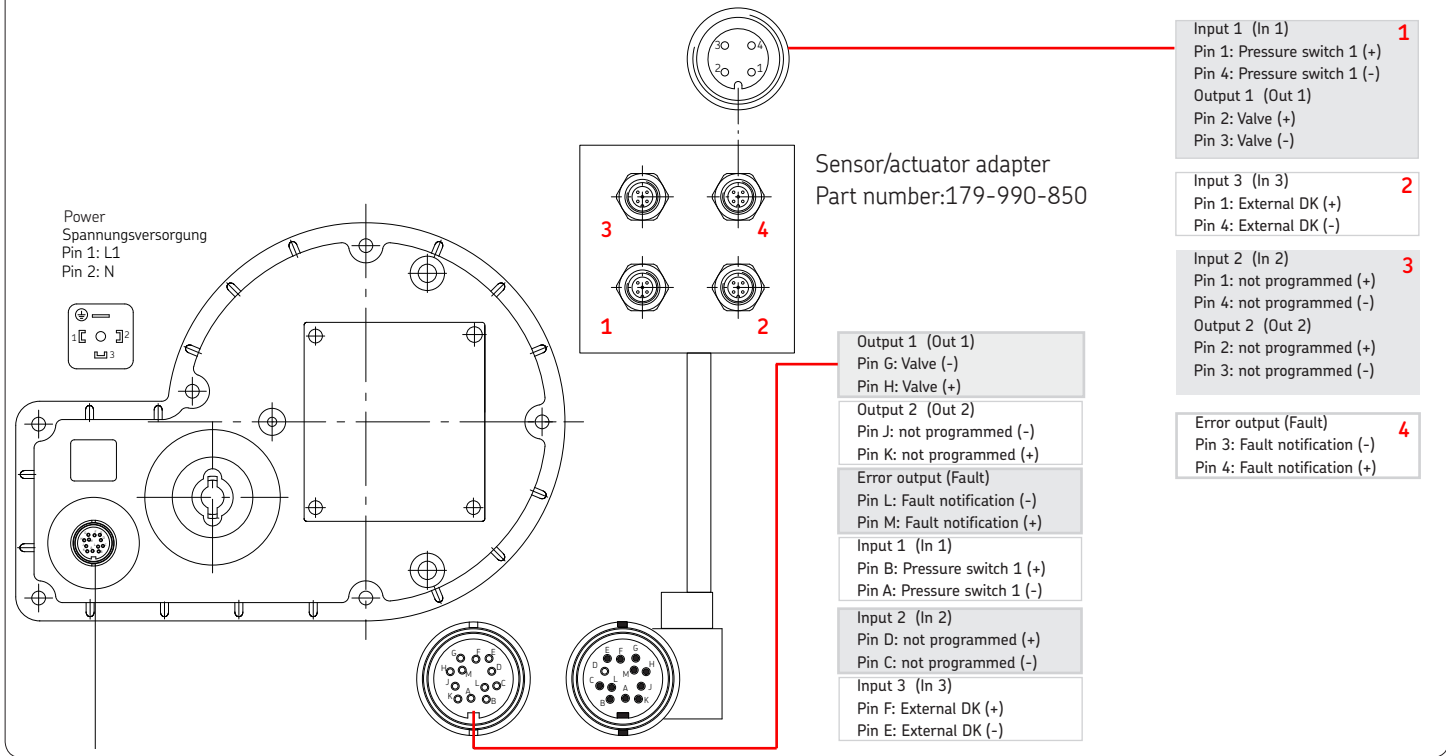

## 4.6.3.2 KFGL ProFlex for progressive centralized lubrication systems

KFGL pump unit, ProFlex programming, 24 VDC, Fig. 27

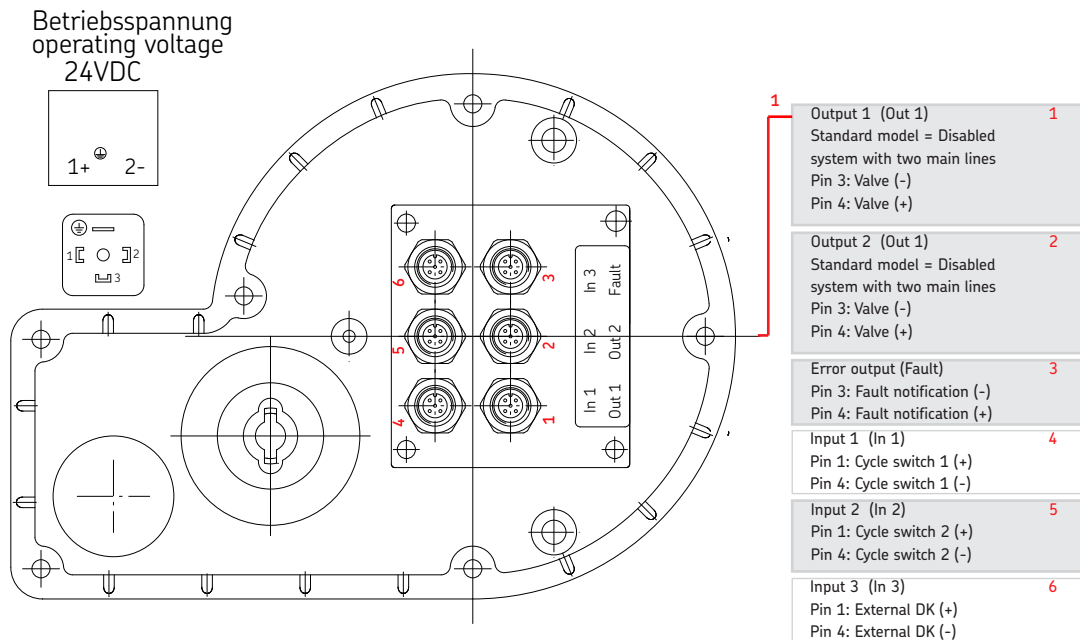

KFGL pump unit, ProFlex programming, 230 VAC, Fig. 28

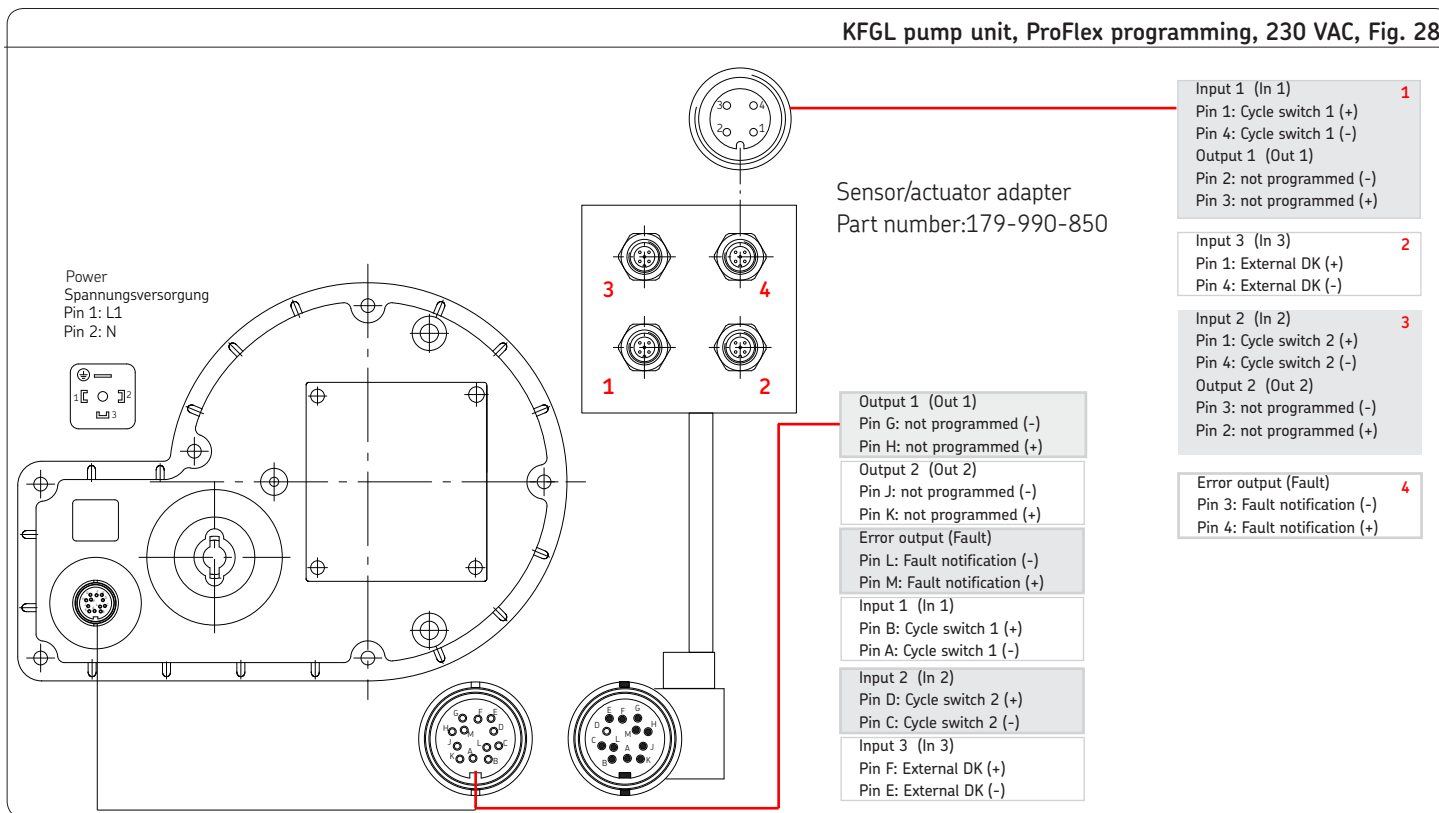

#### 4.6.4 Connectivity of KFGL ProFlex or Monoflex 230 VAC with pressure switch or cycle switch and valve

A double-pin plug with a special cable adapter is required for this application. The connections shown for the double-pin plug 179-990-700 are only valid when used together with the sensor/actuator adapter. See connection diagram for KFGL pump unit, MonoFlex programming, 230 VAC, Fig. 26 or KFGL pump unit, ProFlex programming, 230 VAC, Fig. 28

##### Accessories

Description	Order No.
<b>Cable set</b> M12x1 circular connector with cable (5 m)	<b>179-990-719</b>
<b>Two-way distributor</b> (for connecting to the M12x1 plug on the pump with 2x M12x1 outputs for piston detector or valve (or piston detector and separate indicator lamp))	<b>179-990-700</b>

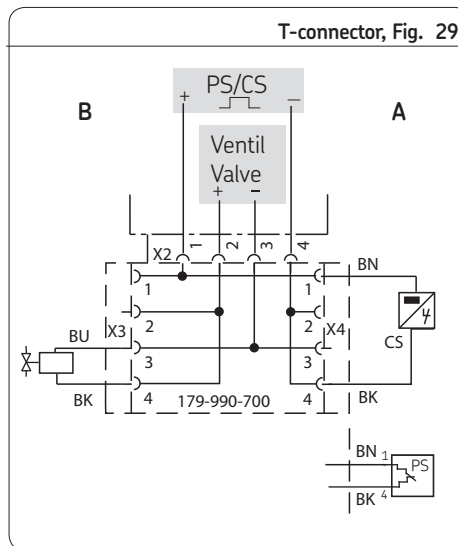

##### Valve connection

PIN	Code	Assignment
1 / 2		Not assigned
3	Out 1/Out 2	Valve ( - )
4	Out 1/Out 2	Valve ( + )

##### Piston detector (CS)

PIN	Code	Assignment
1	In 1/In 2	Voltage ( + )
2/3		Not assigned
4	In 1/In 2	Piston detector (signal)

##### Pressure switch (PS)

PIN	Code	Assignment
1	In 1/In 2	Voltage ( + )
2/3		Not assigned
4	In 1/In 2	Pressure switch (signal)



### 4.6.5 KFGC series (CAN bus)

The KFGC pump unit is available in the voltage design 24 VDC.

There is also a 3-pin Deutsch connector on the underside for the CAN bus connection. Up to six circular connectors can also be attached to control the reversing valves and sensors.

#### 4.6.5.1 KFGC ProFlex and KFGC MonoFlex

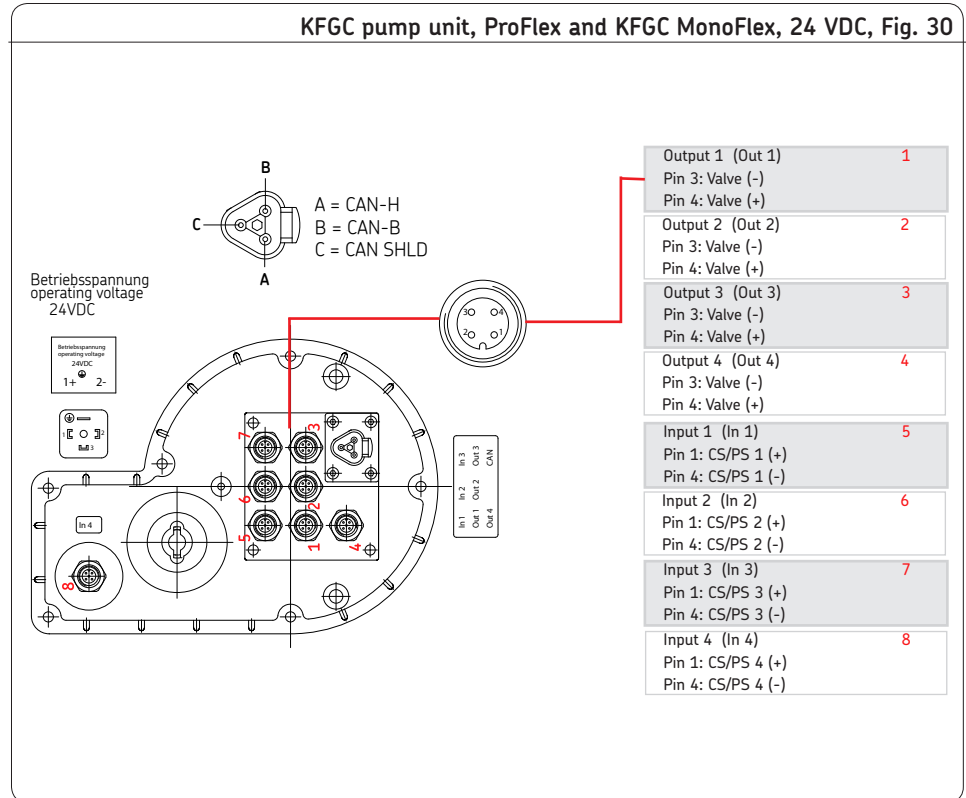

## 4.6.5.2 KFGC ProFlex - rotary , for connection of 5/4 directional control valve

KFGC pump unit, ProFlex, 24 VDC, with 5/4 directional control valve, Fig.31

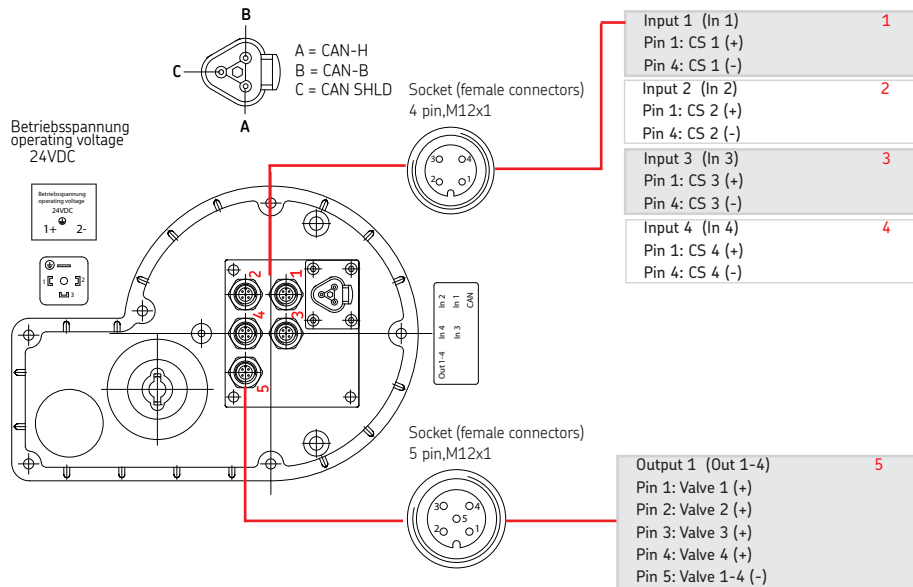

### 4.6.6 Pressure relief valve with integrated pressure regulating valve

(for single-line systems with VR distributors)

#### Technical data

##### Pressure relief valve 24 VDC

Input voltage ..... 24 VDC  
 Rated output ..... 26 W  
 Rated current ..... 1.2 A  
 ON-time ..... 100%  
 Protection class ..... IP 65

##### Pressure regulating valve

Set pressure ..... 200 bar<sup>1)</sup>

Plug-in connection per DIN EN 175301-803

##### Pressure relief valve 230 VAC

Input voltage ..... 230 VAC  
 Coil voltage ..... 205 VDC  
 Rated output ..... 26 W  
 Rated current ..... 0.13 A  
 ON-time ..... 100% at 35 °C

##### Pressure regulating valve

Set pressure ..... 200 bar

Protection class ..... IP 65

Plug-in connection per DIN EN 17530-803

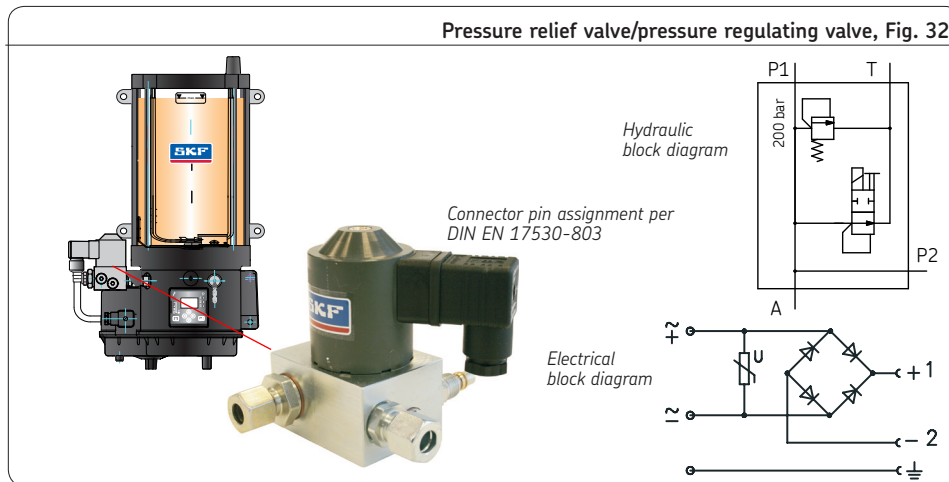

#### Note!

When VKR distributors are used, a max. set pressure of 130 bar for the pressure regulating valve must not be exceeded.

#### Connector pin assignment

PIN	Description
1	= + (Current) Supply voltage potential
2	= - Ground
3	= PE

1) Pressure relief valve with set pressure 130 bar on request

#### 4.7 Fill level monitoring

Three different fill level switches can be fitted as standard on the KFG pump unit for the purpose of indicating the “Minimum” lubricant fill level.

- Order code 1 (formerly W1 control) for greases of NLGI > 1 to ≤ 2
- Order code 2 (formerly W1G control) with signal smoothing, for greases of NLGI > 1 to ≤ 2
- Order code 3 (formerly W2 control) for greases of NLGI ≤ 1

With pump design KFG (without control unit) the monitoring signals are processed by a system provided by the customer; in versions with control units the monitoring switch is connected to the pump's control system.

This effectively prevents the fill level from falling below the minimum, thus preventing any damage to the KFG pump units which could result from that.

On KFGC pump units, fill level control is customized according to customer specifications.

Fill level monitoring W1, Fig. 33





#### 4.7.2 Fill level monitoring, order code 2 (W1G)

with dry contact, signal smoothing, max. 24 VDC, for greases of NLGI Grade  $\geq 2$

The following functions are integrated for the KFG pump unit with signal smoothing:

- Possible isolation of power supply voltages between fill level monitoring and pump power.
- Fill level information can be accessed even during interval time.
- Reverse voltage protection provided in the pump supply line.
- Optional timeout times.

The various functions are realized internally using jumpers, according to the customer-specific pump design.

The monitoring device is connected via a four-pin circular connector, which is plugged into the base of the pump unit.

#### Technical data

Fill level monitoring  
Function . . . . . Dry (potential-free) or non-dry contact, depending on version

#### With dry contact:

Contact form . . . . . Changeover  
Switching capacity, . . . . . max. 60 W  
Switching voltage, . . . . . max. 30 VDC

#### Non-dry contact:

Operating voltage . . . . . 10 to 30 VDC  
Continuous current . . . . .  $\leq 200$  mA  
Internal power consumption . . . . . 6 to 12 mA  
Voltage drop . . . . .  $\leq 1.8$  V at  $I_{term}$

Plug-in connection DIN EN 60947/IEC 947<sup>1)</sup>  
Wiring diagram . . . . . Circular connector M12x1

1) Cable socket - see Accessories, Chapter 16

#### Fill level monitoring W1G, Fig. 35

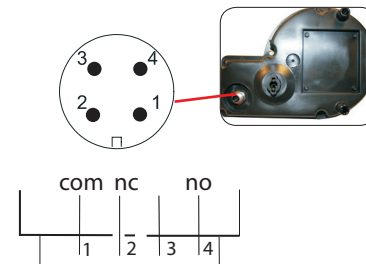

#### Connector pin assignment W1G (pump unit)

PIN	Description
1	= <b>com</b>
2	= <b>NC</b> (pin 1 and pin 2 closed, reservoir empty)
3	= Not assigned
4	= <b>no</b> (pin 1 and pin 4 closed, reservoir full)

### 4.7.3 Fill level monitoring, order code 3 (W2)



**Warning!**  
For greases of class NLGI ≤ 1 only

#### Technical data

Fill level monitoring  
Function . . . . . Switch opens at min.  
+ fill lvl fault notification  
and upon wire breakage.  
Operating voltage . . . 10 to 30 VDC  
Continuous current . . . ≤ 200 mA  
Internal power consumption 6 to 12 mA

EC-Directives. . . . . EN 6094752  
Wiring diagram . . . . . Circular connector M12x1  
Conducted interference as defined by  
IEC 61000-4-6 (test level 3V)  
Radio interference is possible in the range from  
2.4-2.6 MHz. See installation instructions on  
page 17

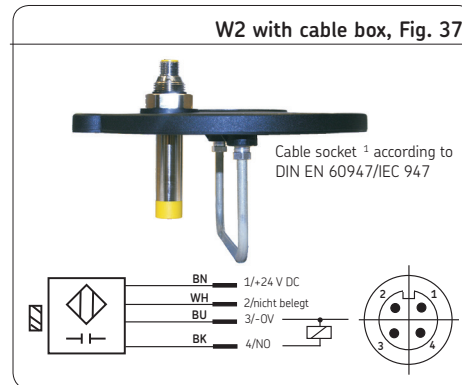
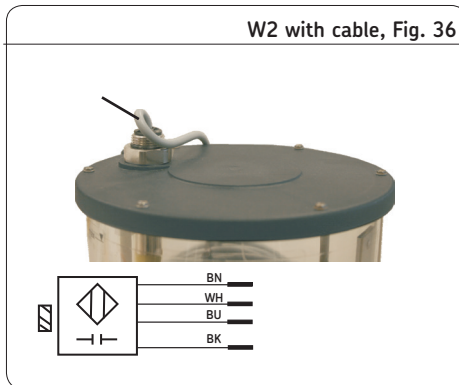

1) Cable socket - see Accessories, Chapter 16



**Note!**  
Customized versions are available in addition to the two standard versions shown. In that case, the fill level switch W2 is to be connected in accordance with the accompanying customer-supplied drawing.

#### Cable assignment (on fill level switch)

Color code	Conductor coloring	Application
BN	Brown	+ Supply voltage
BU	Blue	0 V (0 volts)
BK	Black	NO-contact
WH	White	Not assigned

#### Pin/cable assignment (pump unit)

Pin	Color code	Application
1 =	Brown	+ Supply voltage
2 =	White	Not assigned
3 =	Blue	0 V (0 volts)
4 =	Black	NO-contact

## 4.8 Pump unit fill level control

### Visual

The transparent lubricant reservoir allows for visual fill level control. This must be performed on a regular basis for safety reasons.



### Note!

The entire system must be ventilated if the reservoir has been emptied below the "min" mark.

### Automatic

Pumps of the **KFGS** series allow for automatic fill level control. If the fill level falls below the "min" mark, the lubrication process is stopped and the fault notification "FLL" is issued on the display.

For KFGl and KFGC, see Chapter 14, Fault notifications.

## 4.9 Lubrication line connection

The lubrication line must be connected to the lubrication unit in such a way that no forces can be transferred to the assembled lubrication unit (stress-free connection).



### Warning!

The fittings used to connect the lubrication line should be rated for the maximum operating pressure of the lubrication unit. If they are not, the lubrication line system needs to be protected from excessive pressure by means of a pressure-limiting valve.

For higher operating pressures up to 250 bar as can occur especially in progressive centralized lubrication systems, SKF cutting-sleeve screw unions conforming to DIN 2353 can be used. If using fittings from other manufacturers, pay careful attention to the assembly instructions and technical specifications provided by the manufacturer.

## 4.10 Lubrication line arrangement

The pipes, tubes, shutoff valves and directional control valves, fittings, etc. that will be used must be designed for the maximum operating pressure of the lubrication unit, the permissible temperatures and the lubricants that will be delivered. Furthermore, the lubrication line system needs to be protected from excessive pressure by means of a pressure-limiting valve.

All components of the lubrication line system such as pipes, tubes, shutoff valves, directional control valves, fittings, etc. must be carefully cleaned before assembly. No seals should point inward in the lubrication line system, as this could hinder lubricant flow and introduce contaminants into the lubrication line system. Lubrication lines should always be arranged so that air pockets cannot form anywhere. Avoid changes in the cross-section of the lubrication line from small to large cross-sections in the direction of flow of the lubricant. When the cross-section does change, the transition should be gentle.



#### 4.11 Progressive system ventilation

- Fill pump with lubricant.
- Remove main lines on unit.
- Allow pump to run until lubricant without bubbles is discharged at the straight connector of the pump element.
- Mount main lines.
- Allow pump to run until grease can be seen discharging at all lubrication points.

#### 4.12 Single-line system ventilation

- Fill pump with lubricant.
- Remove main lines (pressure relief valve as necessary) on unit.
- Allow pump to run until lubricant without bubbles is discharged at the straight connector.
- Mount main lines.
- Remove screw plug or pressure switch at end of main and branch lines.
- Allow pump to run until air is no longer discharged at the end of the line sections.
- Mount screw plug or pressure switch.
- Vent lubrication lines and lubrication points and inspect for proper function.

#### 4.13 Note on the rating plate

The rating plate of pump units KFG and KFGS displays important specifications such as type designation and short material description (or customer number).

To avoid loss of this data in case the rating plate becomes illegible, these characteristics should be entered in the following table.

- Enter key data from rating plate in the following table.

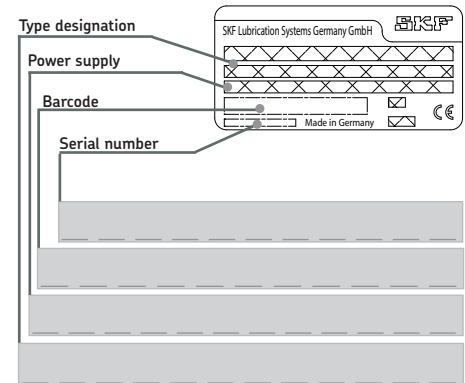



---

**KFG; KFGS; KFGL; KFGC for  
industrial applications**

**Operating instructions associated  
with assembly instructions**  
according to EC Dir. 2006/42/EC for partly completed machinery

## 1. Safety instructions

### 1.1 General information



#### Warning!

These operating instructions must be read and properly understood by the assembler and the responsible technical personnel/operator before assembly and commissioning.

The safety instructions listed in Chapter 1, "Safety instructions," of the assembly instructions also apply without restrictions to these operating instructions.



In addition to the operating instructions, general statutory regulations and other binding regulations for accident prevention and for environmental protection (recycling/disposal) must be observed and applied.

### 1.2 Disclaimer of liability

SKF Lubrication Systems Germany GmbH shall not be held liable for damages:

- Caused by contaminated or unsuitable lubricants
- Caused by the installation of non-original SKF components or SKF spare parts
- Caused by inappropriate usage
- Resulting from improper assembly, configuration or filling
- Resulting from improper response to malfunctions
- Caused by independent modification of system components
- Only media approved for these types of pump units may be used. Unsuitable media may result in pump unit failure and potentially severe bodily injury and property damage.

## 2. Lubricants



#### Warning!

The information on lubricants listed in Chapter 2, "Lubricants," of the assembly instructions also applies without restrictions to these operating instructions.

## 3. Transport, delivery, and storage

SKF Lubrication Systems Germany GmbH products are packaged in accordance with standard commercial practice according to the regulations of the recipient's country and DIN ISO 9001. During transport, safe handling must be ensured and the product must be protected from mechanical effects such as impacts. The transport packaging must be marked "Do not drop!"



### Warning!

The product must not be tilted or dropped.

There are no restrictions for land, air or sea transport.

After receipt of the shipment, the product(s) must be inspected for damage and for completeness according to the shipping documents. The packaging material must be preserved until any discrepancies are resolved.

SKF Lubrication Systems Germany GmbH products are subject to the following storage conditions:

### 3.1 Lubrication units

- Ambient conditions: dry and dust-free surroundings, storage in well ventilated dry area
- Storage time: max. 24 months
- Permissible humidity: < 65%
- Storage temperature: 10 - 40°C
- Light: avoid direct sun or UV exposure and shield nearby sources of heat

### 3.2 Electronic and electrical devices

- Ambient conditions: dry and dust-free surroundings, storage in well ventilated dry area
- Storage time: max. 24 months
- Permissible humidity: < 65%
- Storage temperature: 10 - 40°C
- Light: avoid direct sun or UV exposure and shield nearby sources of heat

### 3.3 General notes

- The product(s) can be enveloped in plastic film to provide low-dust storage.
- Protect against ground moisture by storing on a shelf or wooden pallet.
- Bright-finished metallic surfaces, especially wearing parts and assembly surfaces, must be protected using long-term anti-corrosive agents before storage.
- At approx. 6-month intervals: Check for corrosion. If there are signs of corrosion, reapply anti-corrosive agents.
- Drives must be protected from mechanical damage.

## 4. Assembly

### 4.1 Information on assembly

The assembly procedure for KFG pump units is described in detail in the assembly instructions associated with these operating instructions. Information/instructions about assembling the KFG (S) (L) (C) pump units beyond the scope of the assembly instructions are contained later in this chapter.

### 4.2 Assembly procedure for KFG (S) (L) (C) pump

- Assembly must be performed in accordance with the included assembly instructions and the additional information/instructions contained in this chapter

## 5. Design and function

### 5.1 General information

Pump units of the KFG, KFGS, KFGL and KFGC series are electrically driven reservoir pump units (piston pumps) available with and without an integrated control unit. The pump ensures demand-based supply of lubricant to centralized lubrication systems with progressive feeders or single-line distributors on machines, systems, and vehicles.

The pump units differ in terms of the size and type of lubricant reservoir, the lubricant filling and their control and function monitoring. Powerful CAN bus control system variants allow one unit and a special valve to supply up to four independent zones according to demand.

#### Note!

The exact pump designation of the CAN bus version consists of the particular order code and begins with the KFGC designation. This pump design is listed below under the KFGC designation for the sake of simplifying the descriptions.

### 5.2 Design

Pump units of the KFG, KFGS, KFGL and KFGC series are characterized by their compact construction and are divided into the assemblies for pump housing, lubricant reservoir, control unit, and fill level monitoring. A short description of the individual assemblies follows below.

#### 5.2.1 Pump housing

The pump housing contains, among other things, the pump drive, control unit (KFGS, KFGL, KFGC) and three lubricant outlets for installing a maximum of three pump elements. One pressure regulating valve can be attached to each pump element. When used in single-line systems, a pressure relief valve with an integrated pressure regulating valve is attached to the pump element (max. 2 lubrication zones per pump with KFGL). An optional filler socket can be installed on the pump housing as an alternative to the conical head nipple, to allow filling of the pump when used at low temperatures.

A grease return can also be attached. A display and control screen is mounted on the front side of the KFGS or KFGL design, while the KFGC design has a display attached.

An IrDA interface is integrated into this, which can optionally be used to program the pump.

### 5.2.2 Lubricant reservoir

The lubricant reservoir is available in 2 kg, 6 kg, 10 kg, 15 kg and 20 kg sizes. The reservoirs are made of transparent plastic and have fill level markings that allow the fill level to be monitored visually.

The pump fill level can be monitored either via an integrated rocker switch or by an inductive fill level switch fitted on the lid.

### 5.2.3 Fill level monitoring

There is a choice of three fill level switches for monitoring of the minimum pump fill level. Fill level control W1 (order code 1) and fill level control W1G (order code 2) are used with lubricants up to NLGI Grade  $\geq 2$ . The difference between the two fill level controls is that fill level control W1G is equipped with signal smoothing and a dry (potential-free) contact. The output signal is confined to the following indications:

- Reservoir full
- Reservoir empty

Fill level control W2 (order code 3), on the other hand, is used with fluid greases up to max. NLGI Grade  $\leq 1$ .

### 5.2.4 KFGS and KFGL control units

Pump units of the KFGS series are equipped with an IG502-2-I integrated control unit with a control display. Parameters for interval times (timer), interval pulses (counter) and pump cycle times (contact) can be entered through the control unit.

The KFGL's control unit, model LC502, allows up to three lubrication zones to be lubricated independently. Sectional lubrication is available for differing lubricant requirements; the lubrication lines can be controlled and monitored individually.

### 5.3 KFG pump units

Pump units of the KFG series are reservoir pump units without an integrated control unit. The KFG pump is available in the versions with grease reservoir and in reservoir capacities 2 kg, 6 kg, 10 kg, 15 kg, and 20 kg. With the KFG pump unit, the fill level signal must be processed by a system supplied by the customer. The pump is available in various voltage designs.

On pumps for single-line systems, an electrical pressure relief valve is additionally installed on the pump housing, which ensures that pressure is relieved as required after the feeding operation.

#### 5.4 KFGS pump units

Pump units of the KFGS series are reservoir pump units with an IG502-2-I integrated control unit with a control display. Parameters for interval times (timer), interval pulses (counter) and pump cycle times (contact) can be entered through the control unit.

A piston detector is used to monitor the feeding operation on progressive systems.

The KFGS pump is available in the same reservoir capacities and voltage designs as the KFG series.

The fill level of the pump units is monitored using the fill level switches mentioned in Chapter 5.2.3 (operating instructions) and Chapter 4 (in the assembly instructions) .

The signals from minimum fill level monitoring are processed by the integrated KFGS control unit.

#### 5.5 KFGL pump units

Pump units of the KFGL series are reservoir pump units with an LC502 integrated control unit with a control display. The control unit is pre-programmed with standard settings and easy to operate

The control unit can be used to set the pump run time either:

- based on pump speed
- based on time (hours and minutes) or machine cycles (load-dependent).

Sectional lubrication is available for differing lubricant requirements; the lubrication lines can be controlled and monitored individually. The LC502 also offers a wide range of options for monitoring functions and processes, with up to three lubrication zones able to be monitored independently.

The LC502 is fitted with integrated temperature overload protection and continuous system monitoring with fault detection and fault analysis.

A piston detector is used to monitor the feeding operation on progressive systems; a pressure switch is used for single-line systems.

The KFGL pump is available in the same reservoir capacities and voltage designs and with the same grease follower plates as the KFG/KFGS series.

The fill level of the pump units is monitored using the fill level switches mentioned in Chapter 5.2.3 and Chapter 4 (in the assembly instructions) .

The signals from minimum fill level monitoring are processed by the integrated KFGL control unit.



## 5.6 KFGC (CAN bus)

Pump units of the KFGC series are pump units from the KFG series with an integrated CAN bus control unit.

The integrated LC-CAN 5000 control unit offers the following special features:

- CAN bus interface (SAE J1939), which allows units to be seamlessly integrated into the CAN bus networks.
- The lubrication system can be monitored, operated and configured through the CAN bus.
- The pump can optionally be configured and operated via the IrDA interface.

Moreover, the control unit is able to control and monitor up to four independent zones and to supply them from a single pump unit.

To achieve this capability, electric switch valves which are controlled based on the parameters set for each individual lubrication zone are placed in the main line. The control unit has up to four solid-state switching outputs for this purpose.

In addition to valve control, the outputs can also be configured as digital outputs for other purposes.

In addition to the above-mentioned outputs, up to four digital inputs are available, e.g., for connecting piston detectors, pressure switches or other switching contacts. A detailed description of the electrical connections can be found in Chapter 4 in the assembly instructions.

The control unit's comprehensive monitoring functions allow potential faults to be detected early. This includes, among other things, monitoring the fill level in the lubricant reservoir (minimum), monitoring the signal lines on attached components for line breakage, and monitoring the switching outputs for short circuits.

Important system events such as a low fill level in the lubricant reservoir (minimum) are saved by the control unit and given a time stamp.

This allows the causes of operational faults to be determined more easily.

The flexible parameters and configuration options allow custom lubrication concepts to be implemented for each individual lubrication zone in the system. The control unit can store up to 16 sets of parameters. Each set of parameters contains all the information required to control and monitor the lubrication process. This means that different lubrication scenarios can be prepared and saved then called on when needed. Chapter 4 in the assembly instructions contains instructions on configuring the system.

You can find further descriptions of the SKF-KFGC-CAN bus system under the document numbers 951-170-205 or in the CAN bus control system description 951-130-502-EN.

## 6. Functional description in progressive systems

### 6.1 Functional description for progressive systems with a KFG pump unit

A general progressive feeder system consists of the following components:

- Pump unit with pump element and pressure regulating valve
- Lubrication lines, consisting of main and possibly branch lines, as well as progressive feeders.

When the pump motor is turned on, the piston pump delivers lubricant from the lubricant reservoir to the lubricant outlet. The pump element attached to the outlet delivers the lubricant further, into the downstream main line. The lubricant flows through the main line to the progressive feeder. There, the lubricant is distributed according to the volume required by the lubrication point being supplied.

In progressive systems with a master feeder and secondary feeder, the lubricant coming from the pump unit is delivered to the master feeder. The master feeder distributes the lubricant to the secondary feeders according to

their individual volume requirements. From there, the lubricant flows to the lubrication points.

#### 6.1.1 Pump element

The pump element or elements meter out the lubricant and convey it to the downstream lubrication points or distributors. Five different pump elements are available for the range from 0.8 to 5 cm<sup>3</sup>/min, according to the lubricant volume required (see sections 4.3.2 and 4.3.4 in the assembly instructions).

Layout of the pump elements, Fig. 1

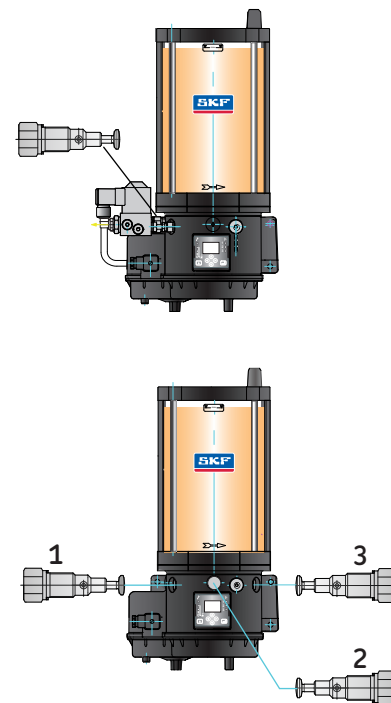

### 6.1.2 Pressure regulating valve

A pressure regulating valve can be installed on the pump element on progressive systems to prevent excessive operating pressure in the lubrication system. If the operating pressure exceeds the cracking pressure of the pressure regulating valve (see Technical Data, Chapter 4.3.4 in the assembly instructions), the valve opens and the lubricant flows back (on versions with a return line) into the lubricant reservoir.

Pressure regulating valve, Fig. 2

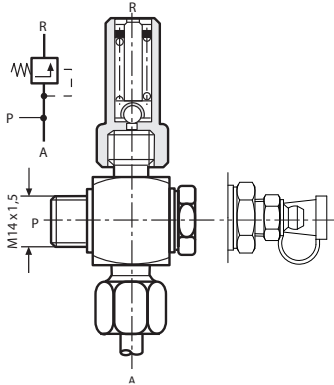

Example of progressive system with KFG pump unit, Fig. 3

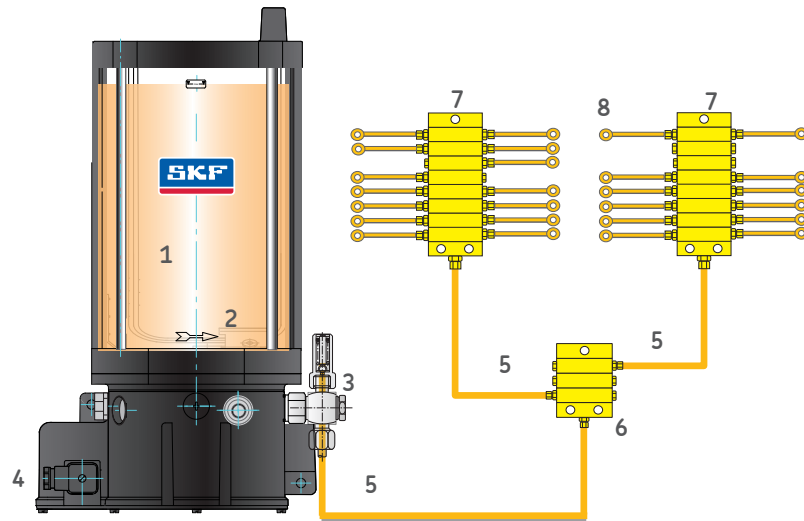

Progressive system with KFG pump unit

- |   |   |   |                    |
|---|---|---|--------------------|
| 1 | KFG unit                                    | 5 | Lubrication lines  |
| 2 | Fill level switch                           | 6 | Master feeder      |
| 3 | Pump element with pressure regulating valve | 7 | Secondary feeder   |
| 4 | Electrical pump connection                  | 8 | Lubrication points |

## 6.2 Progressive system with a KFGS or KFGL pump unit

The general functional description for progressive systems with a KFG pump unit also applies for the design with KFGS and KFGL pump control.

The control unit integrated into the pump housing allows the following additional configuration, monitoring and connectivity options:

- Interval time and pump cycle time can be adjusted independently, including on monitored systems
- Recording of remaining intervals and remaining lubrication times
- Data backup in case of voltage failure
- Non-volatile memory with PIN code protection
- Connectivity for inductive piston detector to monitor the feeder function
- Connectivity for external pushbutton
- Internal fill level monitoring, lubrication cycle stop and fault notification remain on display in case the level falls below minimum
- Fault memory

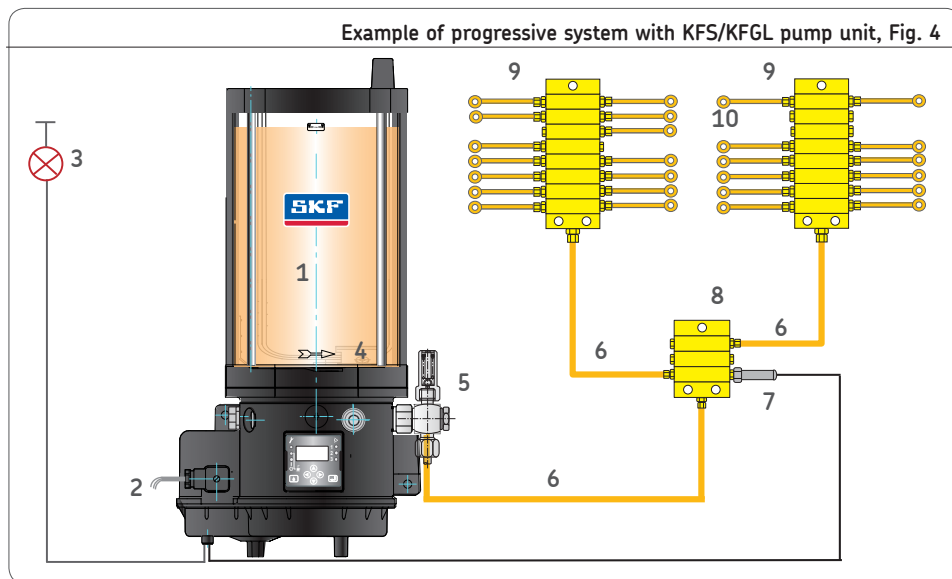

### Progressive system with piston detector

- |   |   |    |                    |
|---|---|----|--------------------|
| 1 | KFGS unit                                   | 6  | Lubrication lines  |
| 2 | Power supply                                | 7  | Piston detector    |
| 3 | Fault indicator light                       | 8  | Master feeder      |
| 4 | Fill level switch                           | 9  | Secondary feeder   |
| 5 | Pump element with pressure regulating valve | 10 | Lubrication points |

### 6.3 Progressive systems with KFGC (CAN bus) pump unit

The general functional description for progressive systems with a KFGS pump unit also applies for the design with CAN bus pump control.

The integrated LC-CAN 5000 control unit permits the lubrication zone of a progressive feeder system to be distributed into individual lubrication segments which can be configured with individual parameters (e.g., contact and interval times). Up to four lubrication segments can be installed in total.

To distribute the lubricant, a corresponding number of electric switch valves is installed in the lubrication line leading from the pump element. A valve is opened as soon as the control unit starts a pump cycle for the corresponding lubrication segment.

The pump can only provide adequate lubrication to one lubrication segment at a time, so it must be ensured that only one valve is opened during operation. This is handled by the control unit in automatic and semiautomatic operation.

When CAN commands are used for control, valve opening must be ensured by selecting the appropriate contact and interval times or by using appropriately programmed processes

in the external lubrication program to switch the valves in a carefully coordinated sequence so that only one valve is opened at a time.

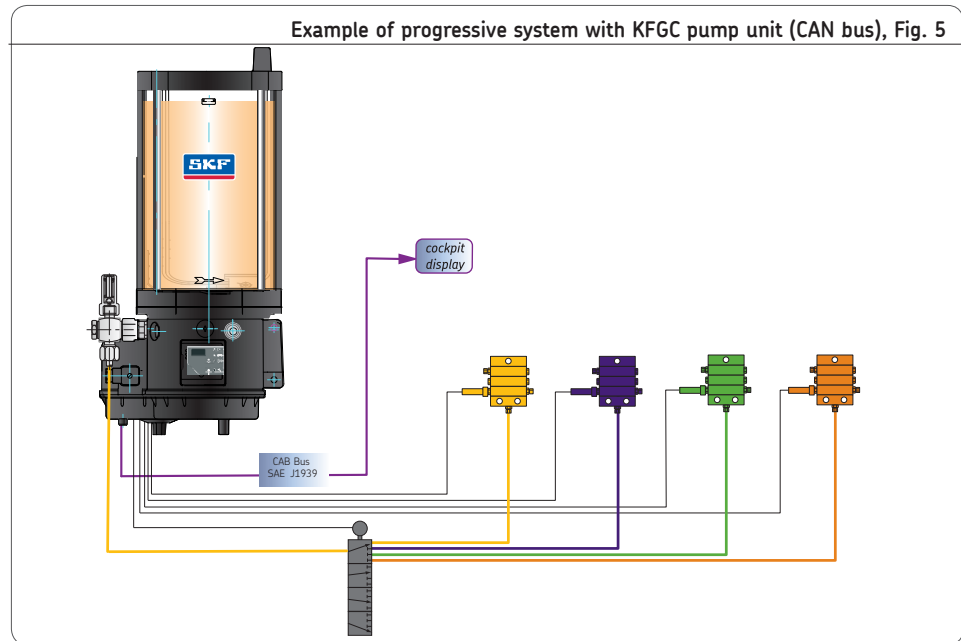

## 7. Functional description in single-line systems

### 7.1 KFG-Pump unit

A general single-line system consists of a pump unit with pump element and pressure regulating valve, pressure relief valve and fill level monitoring, main line and single-line distributors.

When the pump motor is turned on, the piston pump delivers lubricant from the reservoir to the lubricant outlet. The pump element attached to the outlet meters the lubricant and delivers it further through the pressure relief valve attached to the pump element on to the main line. The lubricant flows through the main line to the single-line distributors, where it is metered and passed to the lubrication points. This is performed during or after the pump cycle time, depending on the type of distributors used (prelubrication or relubrication distributors). The pressure relief valve switches after pressure build-up is complete. After the main line has been relieved, the pump unit is now prepared for another lubrication cycle.

#### 7.1.1 Pump element

The pump element delivers the lubricant according to the capacity of the connected single-line distributors. There are both prelubrication distributors and relubrication distributors.

#### 7.1.2 Pressure relief valve

In order to allow another lubrication cycle after metering is complete, the main line must first be relieved of pressure, which also relieves the downstream single-line distributors. The main line and single-line distributors relieve into the lubricant reservoir.

#### 7.1.3 Pressure regulating valve

A pressure regulating valve can be installed single-line systems to prevent excessive operating pressure in the lubrication system. The pressure regulating valve (see Technical Data, Chapter 4.3.5 in the assembly instructions) opens when operating pressure exceeds its cracking pressure. The lubricant escapes through the valve or flows back into the reservoir. This protects the pump unit against overload.

Pressure relief valve/pressure regulating valve,

Fig. 6



Example of single-line system with KFG pump unit, Fig. 7

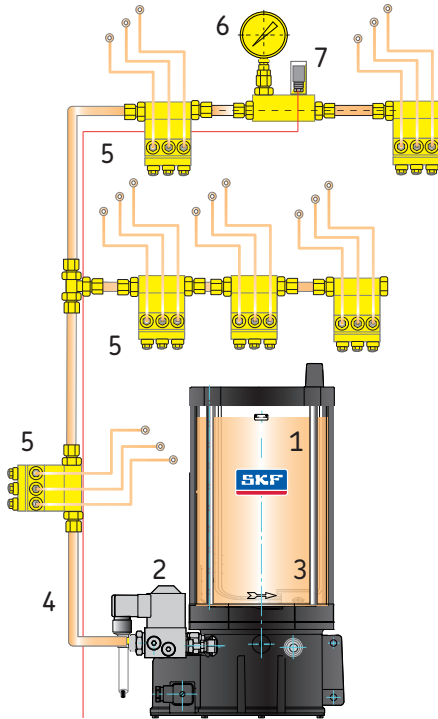

Single-line system with KFG pump unit

- 1 KFG unit
- 2 Pump element with pressure relief valve with integrated pressure regulating valve
- 3 Fill level switch
- 4 Main line
- 5 Single-line distributor
- 6 Pressure gauge for pressure build-up monitoring
- 7 Pressure switch for pressure build-up monitoring

## 7.2 Functional description: (single-line systems) with KFGL-Pump unit

The general functional description for single-line systems with a KFG pump unit also applies for the design with KFGL pump control.

The LC502 control unit integrated into the pump housing allows the following additional configuration, monitoring and connectivity options:

- Interval time and contact time can be adjusted independently for pressure-monitored and pressure-controlled systems
- Configuration of setting times and parameters on a full dot display
- Recording of remaining intervals and remaining lubrication times
- Multizone systems possible
- Extensive fault monitoring/diagnosis
- Recording of fault notifications (diagnostics memory)
- Data backup in case of voltage failure
- Non-volatile memory with PIN code protection
- Connectivity for pressure switch
- Fill level monitoring, lubrication cycle stop and fault notification remain on display in case the level falls below minimum.



Example of single-line system with KFGL pump unit, Fig. 8

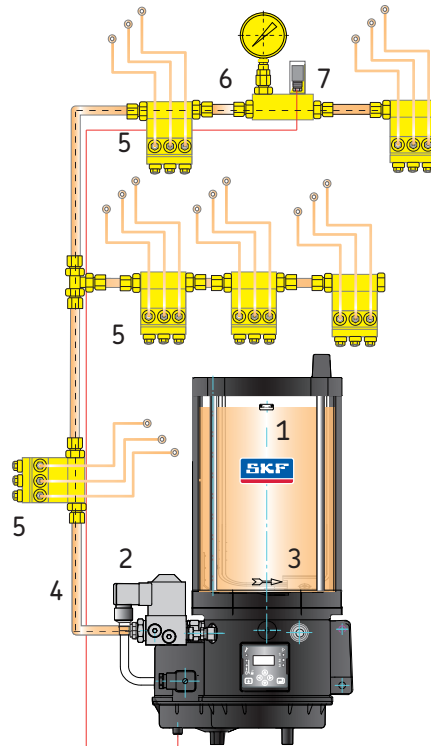

Legend to figure of KFGL single-line system

- 1 Unit with pump element, LC 502 control unit
- 2 Pump element with pressure relief valve with integrated pressure regulating valve
- 3 Fill level switch
- 4 Main line
- 5 Single-line distributor
- 6 Pressure gauge for pressure build-up monitoring
- 7 Pressure switch for pressure build-up monitoring

### 7.3 Functional description in single-line systems with a KFGC (CAN-Bus) pump unit

The general functional description for single-line systems with a KFGC pump unit also applies for the design with CAN bus pump control.

#### 7.3.1 Systems with 3/2 directional solenoid valves

Directional solenoid valves can be used to create a single-line system with up to four lubrication zones. The system can be equipped with or without functionality to monitor pressure build-up and reduction.

#### 7.3.2 Multiple lubrication zones

Using the integrated LC-CAN 5000 control unit, a single-line system can be divided into up to four individually controllable lubrication zones. This is performed using electric switch valves which separate the individual lubrication zones from each other. Four configurable digital inputs/outputs are available to control each lubrication zone. This, as well as the type of valves used, provides various possibilities for setting up lubrication zones.

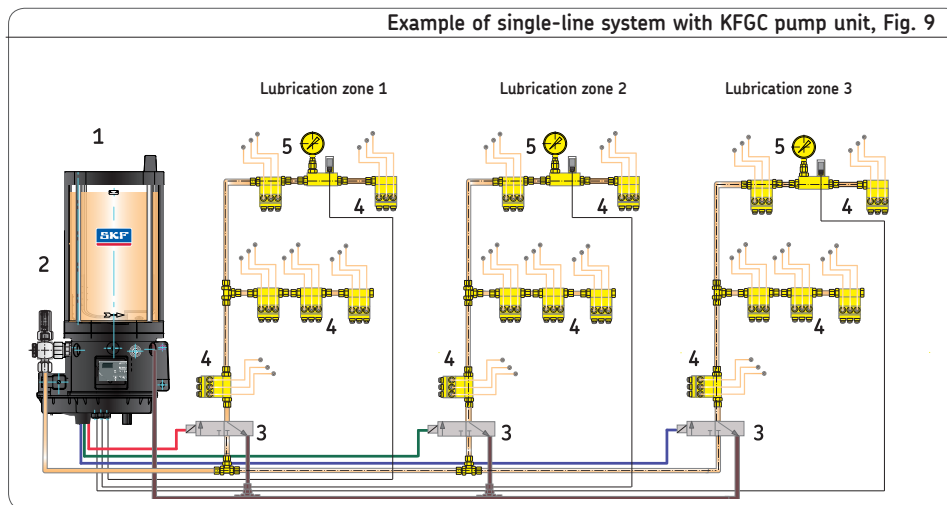

#### Legend

- 1 Pump unit with pump element and fill level monitoring
  - 2 Pressure regulating valve
- Lubrication zone 1/2/3**
- 3 Valve for pressure build-up and relief
  - 4 Single-line distributor
  - 5 Pressure switch for pressure build-up monitoring

## 8. Commissioning

The reservoir unit described here functions automatically. The lubricant transport in the lubrication lines should, however, be subjected to regular visual inspection.

The lubricant fill level in the lubricant reservoir, if present, should likewise be subjected to regular visual inspection. If the lubricant fill level is too low, lubricant needs to be added up to the maximum mark as described in Chapter 4.4.1.



Observe the instructions from the machine manufacturer regarding the lubricants that are to be used.



### Warning!

Only fill using clean lubricant and an appropriate device. Contaminated lubricants can result in severe system malfunction. The lubricant reservoir must be filled without introducing bubbles.



### Warning!

Different lubricants cannot be mixed, as mixing may result in damage and necessitate costly and complicated cleaning of the product/centralized lubrication system.

It is recommended that an indication of the lubricant in use be attached to the lubricant reservoir in order to prevent accidental mixing of lubricants.

### 8.1 General commissioning

Before the product is commissioned, all electrical connections must be inspected.

The lubricant may only be fed without bubbles. The lubricant reservoir, if present, must be filled with clean lubricant without introducing bubbles. The product is then operated until lubricant without bubbles is discharged at all lubrication points.

The process of venting the centralized lubrication system can be facilitated by:

- Opening the ends of the main pipes until lubricant without bubbles is discharged.
- Filling long pipe sections before connecting to the lubrication points.

## 9. KFGS control unit

### 9.1 Display and control elements of control screen

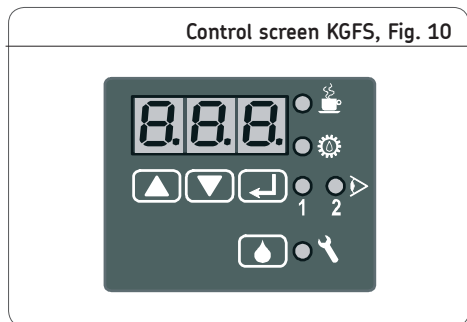

The display and control unit is protected from water splashes and mechanical damage by a transparent plastic cover. The cover must be removed to program the unit and then re-mounted afterwards.



#### Display and control elements of the KFGS control screen

Symbol	Description	Function
	Three-digit LED display	Values and operating status
	PAUSE LED	Interval time
	CONTACT LED	Display contact time (pump operation)
	1 = CS LED	Monitors system function via an external piston detector CS = Cycle Switch, piston detector
	2 = PS LED	PS = pressure build-up monitoring on progressive systems
	FAULT LED	Fault notification
	UP or DOWN key	<ul style="list-style-type: none"> <li>○ Switch on display</li> <li>○ Display values and parameters</li> <li>○ Set values and parameters</li> </ul>
	SET key	<ul style="list-style-type: none"> <li>○ Switch between programming mode and display mode</li> <li>○ Confirm values</li> </ul>
	DK key	<ul style="list-style-type: none"> <li>○ Trigger interim lubrication</li> <li>○ Delete fault notification</li> </ul>

### 9.1.1 Three-digit LED display

The display is off in normal mode. It can be activated by briefly pressing one of the two pushbuttons  . Current values and pre-set parameters are displayed. The display also serves to guide and prompt the operator while programming operating parameters.

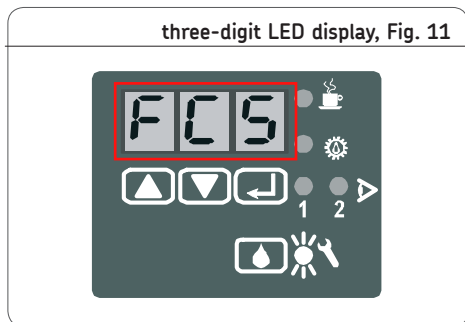

Three-digit LED display			
Display	Meaning	Statement	Control function
t PA	t = TIMER PA = PAUSE	The control unit is functioning as a timer and is currently in PAUSE mode.	Part of lubrication cycle; entry and display value in hours.
c PA	c = COUNTER PA = PAUSE	The control unit is functioning as a counter and is currently in PAUSE mode.	Part of the lubrication cycle; the device counts the pulses from the external timer and compares them with the pre-set values.
t CO	t = TIMER CO = CONTACT	The control unit is functioning as a timer and is currently in a pump cycle (CONTACT).	CONTACT = time during which the pump delivers lubricant; entry and display value in minutes.
c CO	c = COUNTER CO = CONTACT	The control unit is functioning as a counter and is currently in a pump cycle (CONTACT).	CONTACT = time during which the pump delivers lubricant; entry and display value in pulses.
COP	C = Cycle O = OFF P = Pressure	Display the "Monitoring settings" menu	
OFF	Monitoring OFF	The CS and PS monitoring functions are switched off.	No system monitoring
CS	Cycle Switch Piston detector (progressive systems)	Piston detector monitoring is active.	The piston detector is monitored for signals during the CONTACT pump cycle.

Three-digit LED display, Fig. 12



Continuation of "Three-digit LED display" table

Display	Meaning	Statement	Control function
PS	Pressure Switch Pressure switch (single-line systems)	Pressure switch monitoring is active.	The system pressure is monitored by the pressure switch during the pump cycle
FLL	Low Level Fault: fill level too low.	The minimum fill level has been reached in the reservoir.	
FCS	Fault Cycle Switch Fault: Piston detector	No signal from piston detector during pump cycle.	The control unit is currently in FAULT mode. The operational sequence has been stopped.
FPS	Fault Pressure Switch Fault: Pressure switch	No signal from the pressure switch during pump cycle.	The control unit is currently in FAULT mode. The operational sequence has been stopped.
Oh	Operation Hour Meter Operational hours counter	The values shown after this are the number of hours the control unit has operated.	The control unit is currently in FAULT mode. The operational sequence has been stopped.
Fh	Fault Hour Meter Fault-hours counter	The values shown after this are the number of fault hours, i.e., the amount of time the vehicle or machine was operated in FAULT mode.	
blo	Block mode	No signal from the piston detector. Unlike in normal mode, the control unit is still the monitoring sequence. A fault notification is issued if the fault remains for three pump cycles times.	

## 9.1.2 LED display

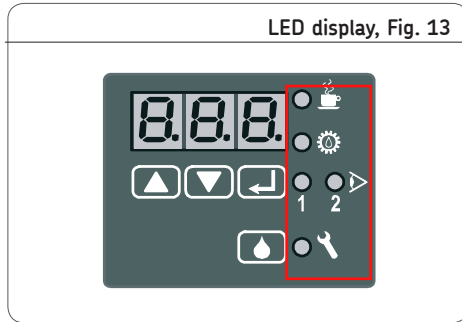

## LED display

LED	LED lights up = display mode	LED flashes = programming mode
	Operating voltage is present on pump unit and control unit, system is currently in operating status PAUSE	Value for PAUSE can be changed.
	Operating voltage is present on pump unit and control unit, system is currently in operating status CONTACT (pump motor ON)	Value for CONTACT can be changed.
CS	A cycle switch (CS) is used for system monitoring. On progressive feeders, monitoring is performed during the pump cycle (CONTACT). <b>1</b> The LED lights up when a signal is received.	Monitoring type can be switched off in programming mode. COP = CS monitoring is active COP = OFF monitoring is switched off
PS	<b>2</b> System monitoring using pressure switch (PS)	
	The operating voltage is present on the pump unit and control unit. The control unit is in operating status FAULT. The cause can be accessed via the LED display and shown as a fault code by pressing the  pushbutton. The operational sequence has been stopped.	

### 9.1.3 Pushbutton operation

Pushbutton, Fig.14

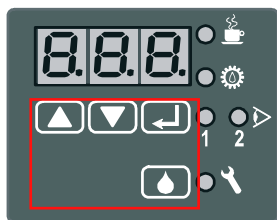

#### Pushbutton operation

Key	Function
	Pressing during PAUSE triggers an interim lubrication. Fault notifications are acknowledged and deleted.
	Switch on the display in display mode Call up next parameter in programming mode Increase displayed value by 1
	Switch on the display in display mode, call up last parameter in programming mode, reduce displayed value by 1.
	Switch between programming mode and display mode Confirm values entered











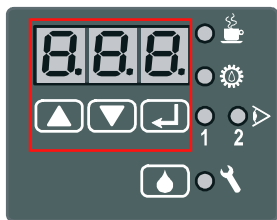







## 9.2 KFGS display mode

Display mode can be identified by the lit-up LED displays. The display does not flash. It is used to query the current settings and operating parameters.

Always start the display mode by briefly pressing one of the two keys  .

Display mode, Fig. 15



			Display mode
Step	Key	Display	
1	  press briefly		The current operating status is shown <b>Example:</b> Pause Timer operation
2			Display remaining interval time for current lubrication cycle. <b>Example:</b> 1 h
3			Display pre-set total interval time <b>Example:</b> 2.6 h (factory setting) <b>Note!</b> Display is in hours
4			Display pump cycle time <b>Example:</b> Timer operation
5			<b>Example:</b> System is currently in operating status Pause, current tCO display (timer COntact) not possible
6			Display of the pre-set value <b>Example:</b> 4 min (factory setting) <b>Note!</b> Display is in minutes
7			Display system monitoring

## Continuation of "Display mode" table

Step	Key	Display
8		 or  or <del>  </del> Monitoring switched off (factory setting)      Monitoring via <b>Piston detector</b> (On progressive systems not admissible!)
9		 Display operating hours
10/11		 +  <b>Example:</b> 1st part of total value      2nd part of total value Write down.      Total value: 00533.8 h Maximum value: 99999.9 h
12		 Display fault hours
13/14		 +  <b>Example:</b> 1st part of total value      2nd part of total value Write down.      Total value: 00033.8 h Maximum value: 99999.9 h
		Display clears <b>Oh</b> and <b>Fh</b> values are stored in EEPROM and cannot be deleted.

### 9.3 KFGS programming



The working/interval times can be reprogrammed to adapt the lubrication intervals and the resulting lubricant quantities to specific requirements.

#### 9.3.1 Start programming mode















 Programming mode can be identified by the flashing LED displays.

#### 9.3.2 Change lubrication interval times





##### Note on step 2

If the 000 factory setting has been changed, the changed code must be selected using the   keys and confirmed using the  key.

#### Change lubrication interval times

Step	Key	Display	
1	 Press for more than 2 s		Display flashes (000 factory setting)
2	 Press briefly (confirm code)		Automatic display of first parameter: "pause in timer operation" "PAUSE" LED flashes
3	 Press briefly		Interval time 1 h (factory setting) (display in hours)
4	 		Set new value <b>Example:</b> 6.8 h = 6 h 48 min
5	 Press briefly (confirm new value)		Display parameter: "Pump cycle time Timer operation" "CONTACT" LED flashes
6			Pump cycle time 4.0 (factory setting) For the permissible setting range for KFG(S) 90-264 VAC -see Technical Data, Chapter
13	Press briefly		(display in minutes)















## Continuation of "Change lubrication interval times" table

Step	Key	Display	
7			Set new value <b>Example:</b> 3 min
8	 Press briefly (confirm new value)		
9	 Press for more than 2 s		Changes are written to memory, the values are activated, and the display clears

### 9.3.3 Configure system monitoring













System monitoring can be changed to activate or deactivate the monitoring functions for lubrication.

When system monitoring is active, you can select monitoring via piston detector or monitoring via pressure switch.

Configure system monitoring			
Step	Key	Display	
1	 Press for more than 2 s		Display flashes (000 factory setting)
2	 Press briefly (confirm code)		Automatic display of first parameter: "pause in timer operation" "PAUSE" LED flashes
3	 Press until:		Beginning of monitoring settings is displayed
4	 Press briefly		System monitoring switched off (factory setting)
5	  Press either until	 Monitoring via piston detector LED "PS" flashes	 (On progressive systems not admissible!)
6	 Press briefly		Confirm new setting
7	 Press for more than 2 s		New settings are written to memory, the values are activated, and the <b>display clears</b>

### 9.3.4 Change operating modes

A change of operation mode means changing to timer operation, counter operation or special applications.

Change operating mode			
Step	Key	Display	
1	 Press for more than 2 s		Display flashes (000 = factory setting)
2	 Press briefly (confirm code)		Automatic display of first parameter: "pause in timer operation" "PAUSE" LED flashes
3			Change from interval time to counter operation (only possible with external electrical pulse generator) Values in pulses
4	 Press briefly to confirm counter operation		Display pump cycle time in timer operation
5			<b>Change from pump cycle time to counter operation, special application</b>
6	 Press briefly		Confirm new setting
7	 Press for more than 2 s		New settings are written to memory <b>and the display clears</b>

### 9.3.5 Change access code

















#### Note!!

This factory default code is now deleted and the new value is activated. Write down the new value and store it in a safe place. The parameters cannot be programmed if the code is lost or forgotten. In this case, the pump unit must be sent to the dealer or authorized SKF branch office.



#### Warning!

Do not enter the digits 321 as the new code.

Change code			
Step	Key	Display	
1	 Press for more than 2 s		Display flashes (000 = factory setting)
2	  Press briefly		key number is selected (321 = factory default setting)
3	 Press briefly (confirm key)		Display flashes (000 = factory setting)
4	 Press briefly (confirm code)		Display flashes
5	  Press either until		new code is set Example: 666 Warning! Do not enter 321.
6	 Press briefly		Confirm new code
7	 Press for more than 2 s		New code is written to memory <b>and the display clears</b>

### 9.3.6 Programming ranges

Programming ranges	
Function	Programming range <sup>1)</sup>
Interval time	0.1 h to 99.9 h
Pump cycle time	0.1 min to 99.9 min
Pulses	1 to 999

1) For the permissible setting range for KFG(S) 90-264 VAC, see Technical Data, Chapter 13.

### 9.3.7 Display ranges

Display ranges	
Function	Display range
Fault hours	0.1 h to 99999.9 h
Operating hours	0.1 h to 99999.9 h

## 9.4 KFGS operating modes

### 9.4.1 Timer operation

The interval and pump cycle are time-dependent.

The lubrication cycle is controlled by the pre-set, time-dependent values for PAUSE and CONTACT.

PAUSE: Values in hours

CONTACT: Values in minutes



Set **tPA** and **tCO** in programming mode.

### 9.4.2 Counter operation

The interval depends on the number of pulses; the pump cycle time is time-dependent. An external pulse generator must be attached as described in Chapter 4 in the assembly instructions.

PAUSE: Values in pulses

CONTACT: Values in minutes

A switch opens and closes based on machine movements, revolutions, etc.

A lubrication is triggered once the set number of pulses (**cPA**) is reached.



Set **cPA** and **tCO** in programming mode.



### 9.4.3 No system monitoring

In this operating mode, the lubrication cycle is controlled solely by the pre-set values for PAUSE and CONTACT.

- ! Monitoring must be switched off.  
**COP = OFF** System malfunctions are not automatically detected or displayed.

### 9.4.4 With system monitoring

In this operating mode, system functions are additionally monitored using external switches. The following can be monitored:

- Fill level in the lubricant reservoir
- Function of progressive feeder using a piston detector

- ! Operational malfunctions are automatically detected and displayed. Monitoring is switched on.  
**COP = CS** or **COP = PS**

### 9.5 Fill level monitoring

- ! If fill level monitoring is installed, it is always active.

If the level in the lubricant reservoir falls below the minimum fill level, the lubricant cycle is stopped and a fault notification is issued on the display.

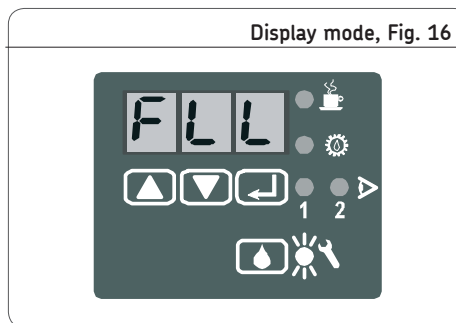

- ! A unit can only be retrofitted from "without" fill level monitoring to "with" fill level monitoring in the factory, which requires that it be sent to the factory for rework.

### 9.5.1 Monitoring via piston detector

- ! **Only possible for centralized lubrication systems with progressive feeders.**

For greases up to NLGI Grade 2.

The piston detector monitors the movement of pistons in the progressive feeder during CONTACT time (pump cycle time). The following monitoring setting must be activated in programming mode:  
**COP = CS** (see Chapter 9.3.3).

Monitoring via piston detector, Fig. 17

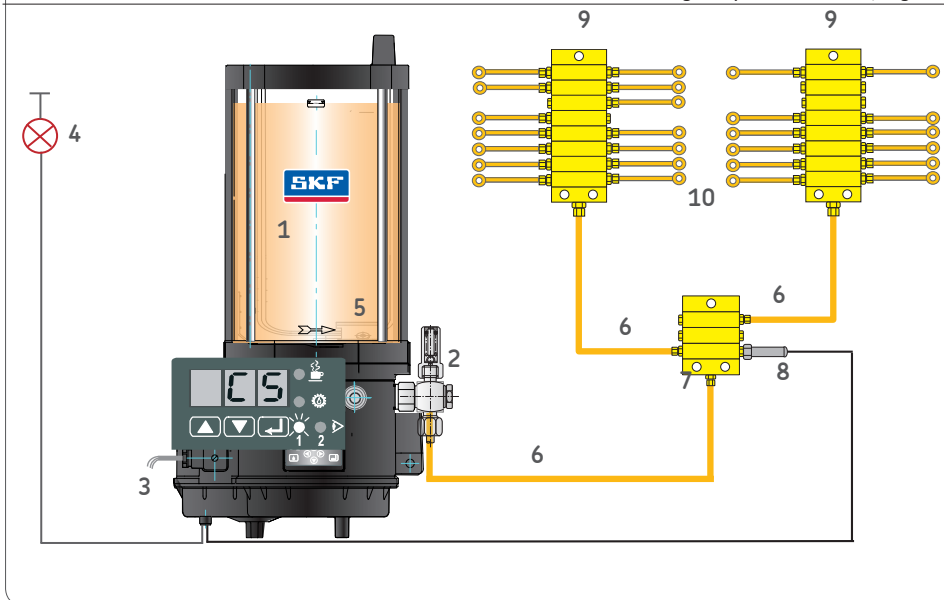

Progressive system with piston detector

- |   |                         |                       |
|---|-------------------------|-----------------------|
| 1 KFGS unit                                   | 4 Fault indicator light | 8 Piston detector     |
| 2 Pump element with pressure regulating valve | 5 Fill level switch     | 9 Secondary feeder    |
| 3 Power supply                                | 6 Main lines            | 10 Lubrication points |
|   | 7 Master feeder         |                       |





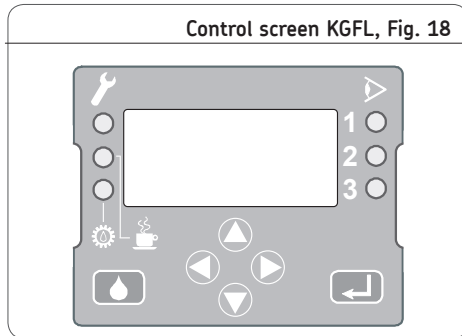

## 10. KFGL control unit

### 10.1 Display and control elements of control screen





The display and control unit is protected from water splashes and mechanical damage by a transparent plastic cover. The cover must be removed to program the unit and then re-mounted afterwards.



**Display and control elements of control screen**

Symbol	Description	Function
	Display	<ul style="list-style-type: none"> <li>○ Menu display</li> <li>○ Display of values and parameters</li> <li>○ Fault notification</li> </ul>
	FAULT LED	Display fault notification <ul style="list-style-type: none"> <li>○ Red LED flashes = error detected</li> <li>○ Red LED lights up = fault on a signal input, no error detected on pump control unit (error is outside pump)</li> </ul>
	PAUSE LED	Display pause time <ul style="list-style-type: none"> <li>Yellow LED lights up = active pump pause time on at least one main line</li> </ul>
	CONTACT LED	Display contact time (pump operation) <ul style="list-style-type: none"> <li>Green LED lights up = active pump run time</li> </ul>
	1 = Output 1 2 = Output 2	Display pump output 1 to 2 <ul style="list-style-type: none"> <li>○ LED on output 1 or 2 lights up = pump output 1 or 2 is switched on. Lubricant is delivered via the indicated line (1 or 2)</li> </ul>
	3 = Inputs	Display all signal inputs <ul style="list-style-type: none"> <li>○ LED lights up = signal change on input port</li> <li>The LED lights up for approx. 1 second each time the signal on the input port changes.</li> </ul>
	ENTER key	<ul style="list-style-type: none"> <li>○ Confirm value</li> <li>○ Confirm input and values</li> </ul>

## Display and control elements of control screen

Symbol	Description	Function
	Operator keys	Operator keys ○ for menu selection (navigation) ○ for editing numerical values
	Operator keys	Operator keys for menu selection (navigation) (arrow key up/down/left) Go to the selected menu based on direction of arrow
		Operator keys for editing numerical values (arrow key up/down) ○ The numerical value is incremented/decremented based on direction of arrow. Press <arrow key right> or <arrow key left> to move the cursor position to the adjacent digit. <b>To exit the editor window without saving the current change, press the key again after reaching the last digit.</b>  Pressing <arrow key up> increments the selected digit by one. Pressing <arrow key down> decrements the selected digit by one. The input value for seconds and minutes can be between 0 and 59; a value between 0 and 65535 can be programmed for hours.
		Operator key for editing numerical values (arrow key right) ○ Pressing the key moves the cursor one position to the right. If the cursor is on the right edge, the edit window closes and the changes are discarded.
	DK key	○ Pressing triggers an interim lubrication. ○ Fault notifications are acknowledged and deleted. ○ Actuators while in configuration mode are ignored.

## 10.2 Display and control menu

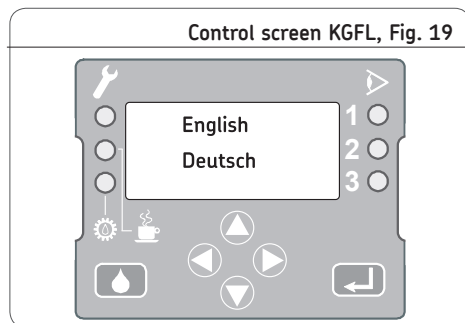

The control unit's display has three rows of eight characters each. Only three options are shown in menu windows containing more than three available choices. Press the <up/down> arrow keys to access further options.

Configuring a setting on the device involves consecutively opening multiple menu windows. The current device setting is then shown on a black background.

Not all possible options are displayed in the settings. Only settings that are available and permitted for the selected device type (ProFlex or MonoFlex) and the current device settings are shown.

The first menu level shows language selection. The language that is currently selected flashes. Upon confirmation, the main menu will be displayed in the selected language.

### 10.2.1 Main menu

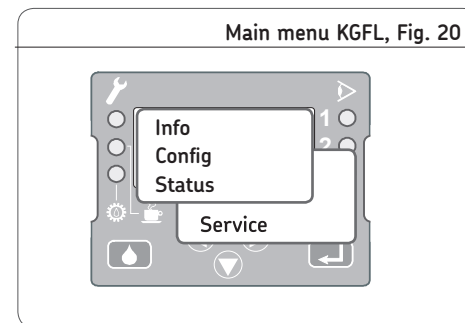

The main menu shows the following options:



- Device-specific information
- Device configuration
- Status information



#### Note!

The Service menu selection is password-protected and can only be accessed by SKF employees.

## Base and main menu

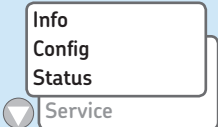
Step	Key	Display	Description
1			<b>Entry mask/language selection</b> The German version is active by default (flashing) Press the “up” arrow key to change to the English version Press the Enter key to confirm.
2			<b>Main menu</b>

## Main menu items

Display	Description
<b>Info</b>	Display device-specific data such as serial number or firmware
<b>Config.uration</b>	Parameter settings
<b>Status</b>	Display current status of control unit
<b>Service</b>	Service menu Menu level only enabled for SKF service personnel

## 10.2.2 Info - Information mode

Information mode is used to query the hardware identification code and the runtimes stored thus far for the system, motor, and error time (system runtime, motor runtime, error time).

**Note!**







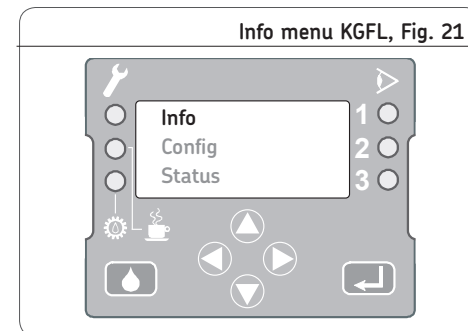



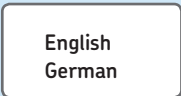

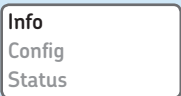

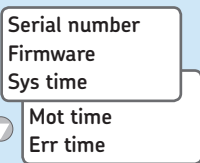

 **No values can be entered or modified in information mode.**

- Selection in information mode is performed by briefly pressing one of the  keys.

Info menu KGFL, Fig. 21

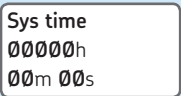

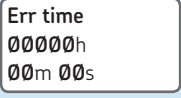
## Information mode

Step	Key	Display	Description
1			<b>Entry mask/language selection</b> The German version is active by default (flashing). Press the "up" arrow key to change to the English version. ● Press the ENTER key
2			<b>Main menu</b> Press the ENTER key to go to the Info menu.
3	  		<b>Info menu</b>  You can switch between menu items using <arrow key up> and <arrow key down>.  Press the ENTER key to go to the selected menu. ● Press the ENTER key
4	   	  	<b>Serial number</b> Each control unit has an assigned serial number that can be viewed by pressing the ENTER key. <b>Firmware</b> This is the current version number of the software and can be viewed by pressing the ENTER key. <b>Sys time</b> This displays the total running time (on-time) of the control unit in hours, minutes, and seconds. <b>Mot time</b> This displays the total runtime of the pump motor in hours, minutes, and seconds. <b>Err time</b> This displays the total time of the current error (if present). If there is currently no error state, the display shows the sum time of all errors detected thus far.  Press the <<arrow key left> to return to the main menu. ● <Press <arrow key left>

### 10.2.3 Config. - Configuration mode

Configuration mode is started by selecting <Config.> in the main menu and pressing the ENTER key. First you need to specify whether you want to edit the configuration data or view it only. If you want to edit the configuration data, a password is requested.











#### Note!

When the correct password is entered, all currently running lubrication procedures are stopped and the configuration mode starts.

If the configuration data will be viewed and not modified, the <Config. menu> will appear upon confirmation by pressing the ENTER key. No changes can be made in this mode.





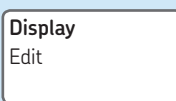

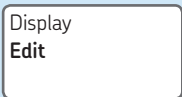

- Selection in configuration mode is performed by briefly pressing one of the  keys.

Configuration menu, table 1 of 2

Step	Key	Display	Description
1			<b>Entry mask/language selection</b> The German version is active by default (flashing). Press the "up" arrow key to change to the English version. ● Press the ENTER key
2	 		<b>Main menu</b> ● Use the arrow key to select "Config." ☞ Press the ENTER key to go to the Config. menu.
3	   		<b>Config. menu</b> <b>Display</b> Press the ENTER key to go to the Configuration menus. Here you can view the configurations for: ○ System ○ Settings ○ Inputs ○ Outputs The active configuration or selection will flash. Data cannot be entered or changed in display mode.

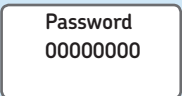

Configuration menu, table 2 of 2

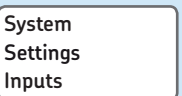
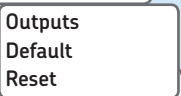
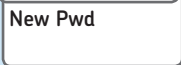
Step	Key	Display	Description
4			<b>Edit</b> ☞ Press the ENTER key to go to the password prompt menu. ● Press the ENTER key
5	    		<b>Password menu</b> ☞ The following request for a password prevents changes being made by unauthorized persons. ● Press <arrow key up> to increment the number by 1, up to 9. ● Press <arrow key down> to decrement the number by 1, up to 0. ● Press <arrow key right> to move to the next password number (max. 7) ● Press the ENTER key ☞ Pressing the ENTER key gives access to the following configuration menus or: ● Press „ <<arrow key left> to return to the main menu.
6	 	  	<b>Configuration sub-menu selection</b> ☞ Press the ENTER key to go to the Config. menu.

### 10.3 Programming a KFGL pump unit

Detailed, separate operating instructions for the IC502 control unit are supplied together with these assembly instructions.

Chapter 5 of these operating instructions lists the adjustment options available to the customer.

#### **Document no. 951-180-004-EN**

For the programming of a KFGL pump unit in MonoFlex design (single-line centralized lubrication system)

#### **Document no. 951-180-005-EN**

For the programming of a KFGL pump unit in ProFlex design (progressive centralized lubrication system)

The operating instructions should be used when programming the IC502 control unit of the KFGL pump unit.



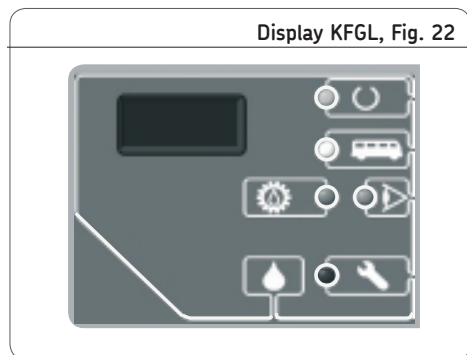

## 11. KFGC control unit

### 11.1 KFGC series (CAN bus)

The display and control screen is protected from water splashes and mechanical damage by a transparent plastic cover. The cover must be removed to operate the unit and then remounted afterwards.

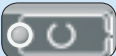



**Display and control elements of the KFGC control screen**

Symbol	LED color	Description	Function
	Green	POWER LED	Lights up when operating voltage present.
	Blue	Pump LED	Lights up when pump is running.
	White	BUS LED	Lights up when communication with the CAN network has been successfully established.
	Yellow	CS/MC LED	Lights up briefly when the control unit detects a signal edge at an input from a piston detector (CS), pressure switch (PS) or from the machine contact (MC).
	Red	FAULT LED	<p><b>LED lights up:</b> Indicates a fault that does not immediately influence the lubrication program (e.g., break in valve cable). The lubrication program continues despite the fault notification.</p> <p><b>LED flashes:</b> LED lights up: Indicates a fault that influences the lubrication program (e.g., break in piston detector cable). The lubrication program is aborted.</p>

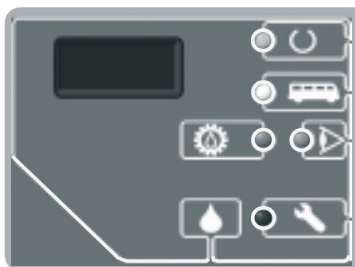
Display KFGC, Fig. 23



Continuation of "Display and control elements of the KFGC control screen" table

Symbol	Description	Function
	IrDA interface	Infrared service interface ○ Read stored status data and fault notifications ○ Configure the control unit via PC
	DK key	○ Trigger interim lubrication ○ Delete fault notification ○ Halt lubrication

## 12. Shutdown/disposing

### 12.1 Temporary shutdown

The described product can be temporarily shut down by disconnecting the electrical supply connections. The instructions in the Chapter "General information" in these assembly instructions must be observed when doing so.

If the product is to be shut down for an extended period of time, follow the instructions in the Chapter "Transport, delivery, and storage" of these operating instructions.

To recommission the product, follow the instructions in the Chapter "Assembly."

### 12.2 Permanent shutdown

If the product will be permanently shut down, the local regulations and laws regarding the disposal of contaminated equipment must be observed.



#### Warning!



Lubricants can contaminate soil and bodies of water. Lubricants must be properly used and disposed of. Observe the local regulations and laws regarding the disposal of lubricants.

The product can also be returned to SKF Lubrication Systems Germany GmbH for disposal, in which case the customer is responsible for reimbursing the costs incurred.

The parts are recyclable.

## 13. Maintenance and service



### Danger!

Work on products that have not been de-energized may result in bodily injury. Assembly, maintenance and repair work may only be performed on products that have been de-energized by qualified technical personnel. Supply voltage must be switched off before opening any of the product's components.



### Danger!

Centralized lubrication systems are pressurized during operation. Centralized lubrication systems must therefore be depressurized before starting assembly, maintenance or repair work, or any system modifications or system repairs.



### Danger!

The described product is pressurized during operation. The product must therefore be depressurized before starting assembly, maintenance or repair work, or any system modifications or system repairs.

SKF Lubrication Systems Germany GmbH products are low-maintenance. However, all connections and fittings must be regularly inspected for proper seating to ensure proper function and to prevent hazards from arising.

If necessary, the product can be cleaned using mild cleaning agents that are compatible with the product's materials (non-alkaline, non-soap). For safety reasons, the product should be disconnected from the power supply and the hydraulic and/or compressed air supply.

Do not allow any cleaning agent to enter the interior of the product during cleaning.

It is not necessary to clean the interior of the product if the product is operated normally and intercompatible lubricants are used.

The interior of the product must be cleaned if incorrect or contaminated lubricant is accidentally filled into the product. If this occurs, please contact the Service department of SKF Lubrication Systems for assistance.



Dismantling of the product or individual parts thereof within the statutory warranty period is not permitted and voids any claims.



Only original spare parts from SKF Lubrication Systems Germany GmbH may be used. Unauthorized alterations to products and the use of non-original spare parts and accessories are prohibited and nullify the statutory warranty.

SKF Lubrication Systems Germany GmbH shall not be held liable for damages resulting from improperly performed assembly, maintenance or repair work on the products.

### 13.1 General information

The following maintenance table contains an overview of the inspections and maintenance work that must be performed on a regular basis.

The maintenance intervals depend on customer-specific settings and operating conditions. The customer is therefore responsible for determining and observing the maintenance intervals on its own.



All work beyond this scope must be performed by authorized SKF Service establishments.



The purity of the lubricants used is the decisive factor in the service life of the pump elements.

### 13.2 Maintenance and repair

The following maintenance and repair work must be performed on a regular basis:

- Check of fill level in lubricant reservoir
- Regularly inspect system components for leaks
- Visually inspect lubrication of bearings
- Inspect electrical cables for damage
- Inspect electrical connections and contacts
- The basic function of the control unit and system components can be inspected by triggering an interim lubrication
- Inspect electrical connections in case of malfunction notifications
- Replace defective fuses with new fuses of the same performance and characteristics

### 13.3 Service

If you encounter problems or have any questions, please contact our sales and service centers or our representatives abroad. A list with current addresses is available on the Internet at:  
[www.skf.com/lubrication](http://www.skf.com/lubrication)

## Maintenance work

Maintenance work	Action	Interval
<b>KFG; KFGS; KFGL; KFGC</b>		
Check of fill level in lubricant reservoir	Refill if necessary.	Depends on planned lubricant consumption
Inspection of system components (lubricant lines, connection points, seals, etc.) for leaks.	Parts that exhibit leaks must be replaced. Please contact an SKF service office	After each refill of the lubricant reservoir or after long operational pauses before commissioning the system
Visual inspection of bearings' lubrication	In case of insufficient bearing lubrication, a fault in the lubrication system or incorrect system configuration is the probable cause. Observe the instructions contained in these operating instructions. If necessary, please contact an SKF service office.	In conjunction with lubrication reservoir filling.
<b>KFGS; KFGL; KFGC</b>		
Check of basic function of control unit and system components	To inspect the basic functions, trigger an interim lubrication by pressing the  key or send the corresponding CAN command.	After each lubrication reservoir filling
Inspection of electrical cables for damage	Damaged cables must be replaced. Please contact an SKF service office	After long operational pauses before commissioning the machine/vehicle
Inspection of electrical connections and contacts for firm attachment and corrosion	Tighten loose contacts. Clean any corroded electrical contacts with a wire brush, then apply a small amount of contact grease after installation	Whenever maintenance is performed, and at least once every six months



## 14. Operational and pump faults

### 14.1 Operational malfunctions

#### 14.1.1 General information

The operator/operating personnel must perform visual fill level control of the lubricant reservoir at regular intervals. The control intervals depend on the amount of lubricant required and the pump's run time. The operator/operating personnel must therefore determine the intervals on their own based on the specific conditions of usage.



If the reservoir has been emptied, the entire system must be ventilated after refilling (see Chapter 6, Assembly).

### 14.1.2 Malfunctions on pump units

#### Pump malfunctions

Fault	Possible cause	Rectification
<b>Pump</b> Agitator in grease reservoir does not rotate during the activated pump cycle time	<ul style="list-style-type: none"> <li>○ Mechanical damage, e.g., motor defective.</li> <li>○ Low voltage</li> <li>○ Electrical connection interrupted</li> </ul>	<ul style="list-style-type: none"> <li>• Replace pump.               <ul style="list-style-type: none"> <li>- Loosen main line at outlet of pressure regulating valve</li> <li>- Loosen electrical connection.</li> <li>- Loosen three fastening screws.</li> <li>- Remove defective pump.</li> <li>- Mount new pump and connect lubrication line and electrical cable.</li> </ul> </li> <li>• Perform commissioning and functional inspection.</li> <li>• Be sure the interval and contact times are correct.</li> <li>• Check or replace fuse.</li> <li>• Check electrical connections.</li> <li>• Check cable set for damage.</li> </ul>

## Pump malfunctions



Fault	Possible cause	Rectification
<p><b>Pump does not function</b> when the  key is pressed, although all electrical connections are ok.</p>	<ul style="list-style-type: none"> <li>○ Electrical control has failed.</li> <li>○ Pump drive/motor is defective.</li> <li>○ Lubricant level in reservoir is below minimum</li> <li>○ Agitator cannot be rotated.</li> </ul>	<ul style="list-style-type: none"> <li>• Check fuse.</li> <li>• Replace pump.</li> <li>• Fill lubricant reservoir to "max."</li> <li>• Replace pump element <b>Note:</b> metering is indicated by grooves or letters</li> </ul>
<p>Pump does not deliver any lubricant, although agitator is rotating.</p>	<ul style="list-style-type: none"> <li>○ Suction problems due to air pockets in grease</li> <li>○ Pump element does not build up pressure, pump element is worn out. (This is indicated when the outlet can be closed with a finger once the main line is removed.)</li> <li>○ Lubricant too stiff</li> </ul>	<ul style="list-style-type: none"> <li>• Dismantle pump element and operate pump using  key until grease discharges from outlet on housing.</li> <li>• Replace pump element <b>Note:</b> metering is indicated by grooves.</li> <li>• If necessary, adjust lubricant to work properly at lowest working temperature.</li> </ul>
<p>Pressure regulating valve on pump opens and lubricant leaks out</p>	<ul style="list-style-type: none"> <li>○ System pressure is over 200/300 bar, e.g., due to feeder blockage or blocked lubrication point.</li> <li>○ Valve is damaged or contaminated, so it does not close properly.</li> </ul>	<ul style="list-style-type: none"> <li>• Check system and repair/rework the system so the maximum system pressure at 20 °C is 200 bar.</li> <li>• Replace pressure regulating valve.</li> </ul>

## 14.2 Malfunctions on KFGS pump unit

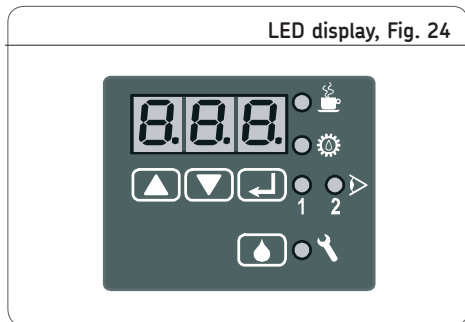
All fault notifications are displayed by the LED  as a centralized fault notification. When a fault notification is issued, the control unit stops the normal operational sequence and the fault that has occurred is saved and displayed. The cause of the fault can be read on the display. This greatly simplifies failure diagnostics, though it requires system monitoring.







### 14.2.1 Display faults

- Start the display mode with one of the two   keys
- Press the  key until you reach the fault notification (see following table)

Fault notification	
Display	Meaning
FCS	<b>Fault Cycle Switch:</b> No signal from piston detector during pump cycle. (see Chapter 9, Block Operation)
FPS	<b>Fault Pressure Switch:</b> No signal from the pressure switch during pump cycle.
FLL	<b>Fault Low Level:</b> The level in the reservoir has fallen below the minimum fill level. The further operational sequence has been stopped.



### 14.2.2 Delete fault notification

 All fault notifications can be acknowledged and deleted using the  key. In timer operation, this can also be performed using an external push-button, if installed.

-  **Warning!**  
Determine and remedy the cause of faults before deleting fault notifications. The user is liable for damages resulting from operating the machine without lubrication.
-  The time during which the control unit and pump unit have been operated without lubrication is stored as fault hours **Fh** in the EEPROM and cannot be deleted.

### 14.2.3 Fault types

Depending on the severity of the fault, the control unit issues either a warning or a malfunction notification (see following table).

Fault types				
Fault type	Definition	Display	Example of fault	Response by control unit
<b>Malfunction</b>	<p>A fault has occurred that affects the proper functioning of the lubrication system.</p> <p>The lubrication points may not be supplied with adequate lubrication because a malfunction has affected the proper functioning of the lubrication system.</p> <p> Malfunctions must always be remedied immediately.</p>	<p> -LED lights up</p>	<p>Insufficient number of piston detector signals from a lubrication segment during the pump cycle time</p>	<p> Block operation up to configured number of repetitions</p> <p>- If the piston detector signal has still not been received, the valve is closed and a fault notification is generated.</p>

### 14.2.4 Recording fault times

#### Fault-state counter

The amount of time that passes from issuance of a failure notification to its acknowledgment is added up in hours. After acknowledgment, this value is automatically transferred to the fault-hours counter.

#### Fault-hours counter

The fault-hours counter adds up all fault-state times occurring during the total running time of the unit. The current counter reading can be read in display mode in two blocks of three digits each by calling up the parameter **Fh** (see Chapter 8).

The maximum reading that can be displayed is 99 999.9 hours.

The smallest recordable interval is

0.1 hours = 6 minutes. The memory cannot be deleted.

### 14.2.5 Malfunctions on KFGS pump unit with a progressive feeder system

#### Block operation

Block operation is the reaction of the control unit to the absence of signals from the piston detector.

#### Possible causes:

- Defective lubrication lines
- Blocked progressive feeder
- Defective piston detector
- Insufficient lubricant

#### No signal from piston detector during pump cycle:

- Normal operation is interrupted.
- Block pause begins with query to piston detector

No signal from piston detector during block pause:

- Second lubricating cycle begins in block operation

As soon as a signal is received from the piston detector, block operation is aborted and the normal lubricating cycle starts with a pause.



A total of three lubrication cycles are performed with query to the piston detector.

#### No signal from the piston detector, Fig.25

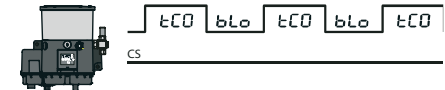

Three pump cycles and two block pauses without signal from the piston detector:

**Block operation is aborted**  
**Malfunction notification is issued.**

	Duration of block pause
<b>Pause</b>	<b>Normal operation blo</b>
<b>tPA block pause</b>	
0.1 h = 6 min	6 min
0.2 h = 12 min	12 min
0.3 h and longer	15 min

- Determine and remedy cause of fault.

### 14.3 Malfunctions on KFGL pump unit

All fault notifications are displayed by the LED .

Key to LED display:

- Red LED flashes = error detected
- Red LED lights up = fault on a signal input, no error detected on pump control unit (error is outside pump)

The LC502 control unit is able to detect a range of different system faults. The control unit causes the red LED to flash when a fault is detected. In some cases the control unit switches off the affected lubrication line or all lubrication lines. An active fault is viewed as follows: In the main menu, select device status <Status> and then the fault menu. Select <Fault> in the status menu. Upon confirmation, the sources of all detected faults are displayed. A fault can be selected in the menu to view its details.

#### 14.3.1 Display faults



##### Warning!

Determine and remedy the cause of faults before deleting fault notifications. The user is liable for damages resulting from operating the machine without lubrication.

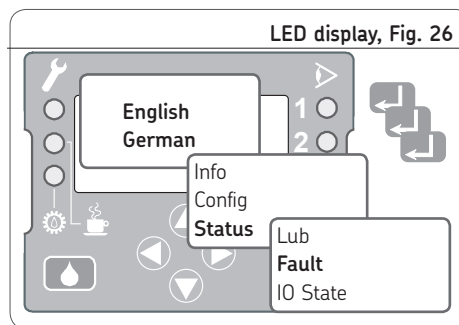

#### 14.3.2 Delete fault notification

All fault notifications can be acknowledged and deleted using the  key; the lubrication process is then restarted in all lines. In some cases this may be able to be done with an external pushbutton (DK).

#### 14.3.3 Fault types

#### 14.3.4 Fault notifications

Detailed, separate operating instructions for the IC502 control unit are supplied together with these assembly instructions. Chapter 10 of these operating instructions contains the operational and pump faults for the KFGL unit.

##### Document no. 951-180-004-EN

Pump unit in MonoFlex design  
(single-line centralized lubrication system)

##### Document no. 951-180-005-EN

Pump unit in ProFlex design  
(progressive centralized lubrication system)

Refer to the operating instructions to remedy faults on a KFGL pump unit.

### 14.3 Malfunctions on KFGC pump unit

All fault notifications are displayed by the LED .

Key to LED display:

**Warnings** are indicated by a constant LED  light. At the same time, the fault notification is stored in the FRAM.

**Malfunctions** are indicated by a flashing LED  light. At the same time, the fault notification is stored in the FRAM.

- LED lights up:  
Indicates a fault that does not immediately influence the lubrication program (e.g., break in valve cable). The lubrication program continues despite the fault notification.
- LED flashes:  
LED lights up: Indicates a fault that influences the lubrication program (e.g., break in piston detector cable). The lubrication program is aborted.

The comprehensive monitoring functions of the LC-CAN 5000 control unit allow faults in the operational process to be detected, registered and displayed.

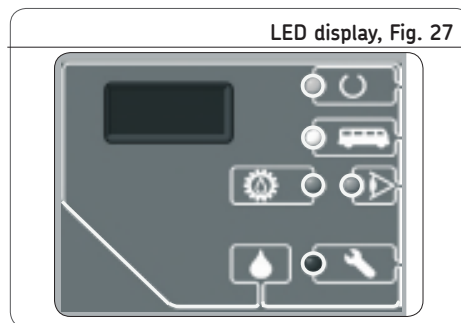

#### 14.3.1 Faults detected by control unit

#### 14.3.2 Fault types

#### 14.3.3 Read faults

#### 14.3.4 Remedy faults

For a KFGC pump unit, detailed, separate operating instructions for the LC-CAN5000 control unit are supplied together with these assembly instructions.

Chapter 10 of these operating instructions contains the operational and pump faults for the KFGC unit.

#### Document no. 951-130-502-EN

Pump unit with LC-CAN5000 control unit

Refer to the operating instructions to remedy faults on a KFGC pump unit.

## 15. Technical data

Protective measures that must be taken for operation according to the intended use in machinery:

KFG; KFGS; KFGL, KFGC... 24 VDC:

- "Functional Extra Low Voltage",  
"Protective Extra Low Voltage"  
(PELV)
- Disconnect the unit for insulation and voltage inspection according to EN 60204-1 1992

### Technical data

#### Data universally applicable to KFG, KFGS; KFGL; KFGC

Description	Key data/Display		
Conditions for electrical connections	<b>24 VDC</b>	<b>115 VAC</b>	<b>230 VAC</b>
Rated voltage		<sup>3)</sup>	<sup>3)</sup>
Power consumption (load-dependent)	1.25 A <sup>1)</sup>	1.5 A	0.9 A
Power consumption (maximum)	< 2.5 A	20 A	40 A
Pump starting current (approx. 20 ms)	4.5 A	6 A <sup>4)</sup>	6 A <sup>4)</sup>
Max. back-up fuse	4 AT <sup>2)</sup>		
Fill level switch W1	NLGI 2 Fault notified by pulse		
Fill level switch W1G	NLGI 2 Fault notified by non-dry contact		
Fill level switch W2	NLGI ≤ 1 Fault notified by capacitive proximity switch		
Electrically controlled pressure relief valve	<b>24 VDC or 230 VAC</b> see Chapter 4.10, Page 41		
<b>Weight with full lubricant reservoir</b>	<b>kg</b>		
2 kg version	<b>7.5</b>		
6 kg version	<b>13.5</b>		
10 kg version	<b>27.0</b>		
15 kg version	<b>34.5</b>		
20 kg version	<b>41.5</b>		

1) Typical value at ambient temperature = 25 °C and operating pressure = 150 bar

2) Conductor: cross-section 1.5 mm<sup>2</sup> Length ≤ 12

3) no information

4) line safety switch to characteristic type "C"



## Continuation of "Technical data" table

Description	Value	
	24 VDC	90...264 VAC
Perm. operating temperature with spring return pump elements	-25 °C to +70 °C	-25 °C to +60 °C
Perm. operating temperature with spring return pump elements	-30 °C to +70 °C	-30 °C to +60 °C
Electrical values	See page 104	
Protection class according to DIN 40050, T9	IP56	IP56
Operating mode/ON-time according to VDE0530/ DIN 41756	S1 continuous operation	At -25 °C to 40 °C: S1 continuous operation at 40 °C to 60 °C: • Run time 0 to 10 min. minimum interval time = 4 x Run time (20% ON-time) • Run time 10 to 15 min. minimum interval time = 2 h
<b>Data universally applicable to KFG, KFGS; KFGI; KFGC</b>		
Max. back pressure	300 bar with spring return pump elements 350 bar with spring return pump elements	
Max. Number of outlets (if less than 3 outlets are required, close unneeded outlets with screw plugs)	3	
Delivery rates [cm <sup>3</sup> /min]	KFG1.U1 = 2.5   KFG1.U2 = 1.8   KFG1.U3 = 1.3   KFG1.U4 = 0.8 <b>KFG1.U0 = 5.0 at max. 200 bar</b> <b>KFG1.U0-E at max. 250 bar</b>	
Lubricant	NLGI Grade 1 to 2 greases with EP additives, compatible with plastics, NBR elastomers, copper and copper alloys	
Flow pressure	Up to max. 700 mbar	

## Continuation of "Technical Data" table

KFGC data	
Description	Key data
<b>Switching outputs</b> Type  Max. current-carrying capacity  Modes of operation	<b>All types</b> Solid-state output, short-circuit-proof and overload-proof  <ul style="list-style-type: none"> <li>• with simultaneous operation of 4 outputs: 1.0 A</li> <li>• with simultaneous operation of 2 outputs: 1.25 A</li> <li>• with operation of one output: 1.5 A</li> </ul> <ul style="list-style-type: none"> <li>• Single operation</li> <li>• Parallel connection of multiple outputs while simultaneously increasing output current</li> </ul>
<b>Signal inputs</b> Type  Connectivity	<b>All types</b> digital solid-state input, short-circuit-proof  <ul style="list-style-type: none"> <li>• Switching contact, no detection of wire breakage</li> <li>• Dual wire sensors (e.g., piston detector), detection of wire breakage</li> </ul>
<b>Communication connections</b>  CAN bus Infrared	<b>All types</b>  SAE J1939 IrDA
<b>Electrical data</b>  Protection class  Operating mode/ON-time according to VDE0530/DIN 41756	<b>All types</b>  according to DIN 40050, T9 IP5k5  S1 continuous operation

## 16. Accessories

Accessories		
Description	Data	Order No.
M12x1 connector, 4-pin	with 5 m cable, 4x 0.25 mm <sup>2</sup> , protection class IP 67 (mounted)	<b>179-990-719</b>
Double-pin plug (T-connector)	Double-pin plug (two-way distributor) (for connecting to the M12x1 plug on the pump with 2x M12x1 outputs for piston detector and separate indicator lamp)	<b>179-990-700</b>
M12x1 socket	without cable, with 4 pins, protection class IP 67 (mounted)	<b>179-990-371</b>
M12x1 angle plug	without cable, with 4 pins, protection class IP 67 (mounted)	<b>179-990-372</b>
M12x1 plug, straight	with 5 m cable, 4x 0.25 mm <sup>2</sup> , , protection class IP 68 (mounted)	<b>179-990-600</b>
M12x1 angle plug	with 5 m cable, 4x 0.25 mm <sup>2</sup> , protection class IP 68 (mounted)	<b>179-990-601</b>
Cable socket according to DIN 43 650	Type A (ISO 4400), pivoted, without LED, 1.5 mm <sup>2</sup> , line diameter 6 mm to 9 mm	<b>179-990-034</b>
Cable socket according to DIN 43 650	Type A (ISO 4400), pivoted, without LED, 1.5 mm <sup>2</sup> , , line diameter 4.5 mm to 7 mm	<b>179-990-147</b>
Cable socket according to DIN 43 650	Type A (ISO 4400), pivoted, with rectifier and yellow LED, for connected on MonoFlex Pressure relief valve, version 230 VAC.	<b>24-1882-2167</b>



Additional data and electrical plug-in connections are available in brochure No. 1-1730-EN, "Electric Plug-and-Socket Connectors."



The operating instructions/functional description of the corresponding control unit must be observed!

### External control units

Application	Type designation Order number	Features
Piston distributor for single-line systems	<b>EXZT2A02-E</b>	Pulse generator/counter with adjustable interval time, interval time extension, monitoring of pressure build-up and reduction, and fill level monitoring
Piston distributor for single-line systems	<b>EXZT2A03-E</b>	Pulse generator/counter with selectable monitoring time, monitoring of fill level and pump cycle time (stroke monitoring), adjustable delay time, and interval time extension
Progressive systems	<b>EXZT2A05-E</b>	Pulse generator/counter with adjustable interval time, interval time extension, pressure build-up monitoring, pulse monitoring, and fill level monitoring
Progressive systems	<b>EXZT2A06-E</b>	Pulse generator/counter with selectable monitoring time, monitoring of fill level and pump cycle time (stroke monitoring), adjustable delay time, interval time extension, and pulse monitoring
Piston distributor for single-line systems	<b>EXZT2A07-E</b>	Pulse generator/counter with adjustable interval time, interval time extension, pressure build-up monitoring, fill level monitoring, and fill level pre-warning
Electronic timer for centralized lubrication systems	<b>IG351-10-E</b>	Pulse generator with adjustable interval time, adjustable pump cycle time, and fill level monitoring with NO-contact
Piston distributor for single-line systems	<b>IGZ38-30-E</b>	Pulse generator/counter with adjustable interval time and pressure build-up monitoring, and fill level monitoring with NC contact (wire breakage monitoring)
Piston distributor for single-line systems	<b>IGZ36-20-E</b>	Pulse generator/counter with adjustable interval time, monitoring of pressure build-up and reduction, and adjustable delay time
Piston distributor for single-line systems	<b>IGZ36-20-S6-E</b>	Same as IGZ36-20-E, but with fill level monitoring with NC contact (wire breakage monitoring)

## External control units

Application	Type designation Order number	Features
Progressive systems	<b>IGZ51-20-E</b>	Pulse generator/counter with selectable intermittent or continuous pump operation, with adjustable stroke rate, selectable interval time and monitoring time, and monitoring of fill level and pump cycle time
Progressive systems	<b>IGZ51-20-S2-E</b>	Same as IGT51-20, but with non-volatile memory in case of power failure
Piston distributor for single-line systems	<b>IGZ51-20-S3-E</b>	Pulse generator/counter with adjustable interval time, interval time extension, monitoring of pressure build-up and reduction, adjustable delay time and connectable non-volatile memory in case of power failure
Progressive systems	<b>IGZ51-20-S7-E</b>	Same as IGZ51-20-S2, but with fill level switch as NC contact, pump cycle time = set monitoring time
Progressive systems	<b>IGZ51-20-S8-E</b>	Pulse generator/counter with selectable intermittent or continuous pump operation, prelubrication, selectable interval time and monitoring time, monitoring of fill level, pump cycle time and pulses, and non-volatile memory in case of power failure

## 951-170-212-EN

The contents of this publication are the copyright of the publisher and may not be reproduced in whole or in part without permission of SKF Lubrication Systems Germany GmbH. Every care has been taken to ensure the accuracy of the information contained in this publication. However, no liability can be accepted for any loss or damage, whether direct, indirect or consequential arising out of use of the information contained herein.

All SKF products may be used only for their intended purpose as described in these assembly instructions with associated operating instructions. If assembly/operating instructions are supplied together with the products, they must be read and followed. Not all lubricants can be fed using centralized lubrication systems. SKF can, on request, inspect the feedability of the lubricant selected by the user in centralized lubrication systems.

Lubrication systems and their components manufactured by SKF are not approved for use in conjunction with gases, liquefied gases, pressurized gases in solution, vapors or such fluids whose vapor pressure exceeds normal atmospheric pressure (1013 mbar) by more than 0.5 bar at their maximum permissible temperature.

Particular attention is called to the fact that hazardous materials of any kind, especially the materials classified as hazardous by EC Directive 67/548/EEC, Article 2, Para. 2, may only be filled into SKF centralized lubrication systems and components and delivered and/or distributed with the same after consultation with and written approval from SKF.

### **SKF Lubrication Systems Germany GmbH**

Motzener Strasse 35/37 · 12277 Berlin · Germany  
PF 970444 · 12704 Berlin · Germany  
Tel. +49 (0)30 72002-0 · Fax +49 (0)30 72002-111  
[www.skf.com/schmierung](http://www.skf.com/schmierung)

### **SKF Lubrication Systems Germany GmbH**

2. Industriestrasse 4 · 68766 Hockenheim · Germany  
Tel. +49 (0)62 05 27-0 · Fax +49 (0)62 05 27-101  
[www.skf.com/schmierung](http://www.skf.com/schmierung)

